

IMPORTANT

READ CAREFULLY BEFORE USE

KEEP SAFE TO CONSULT AT A LATER DATE



BOSCH

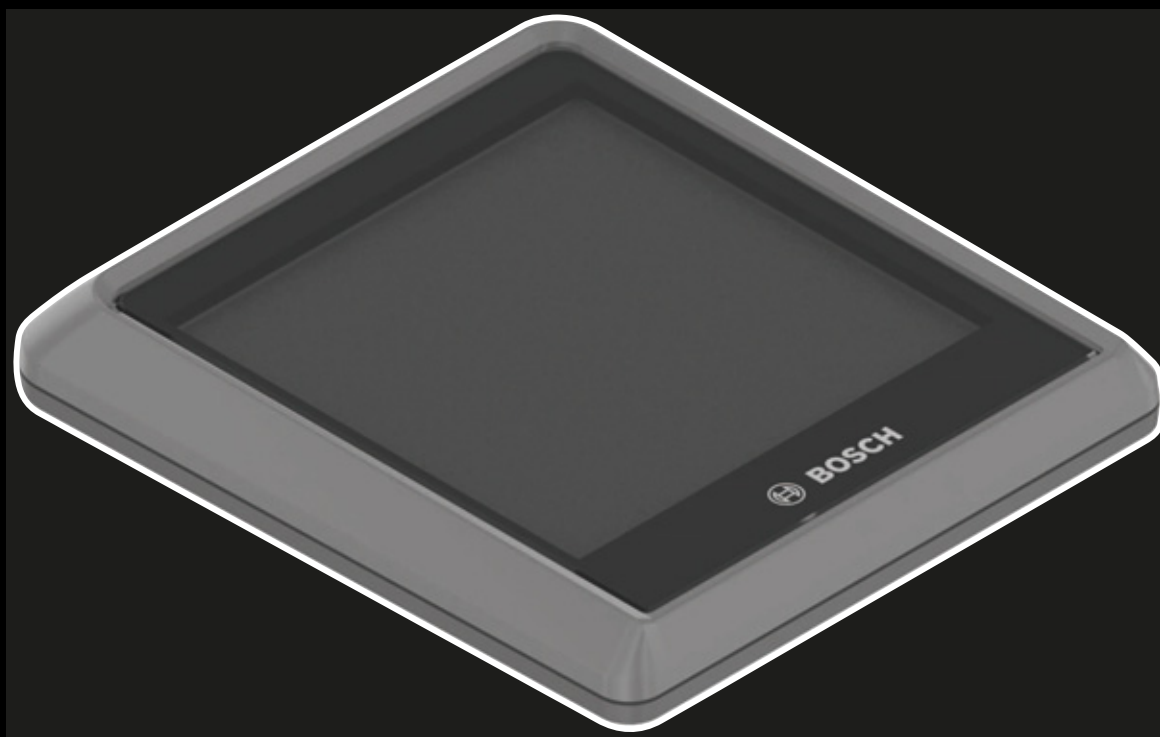

Original operating instructions for BULLS pedelegs with BOSCH Intuvia 100 display and LED Remote on-board computer

Cross Rider EVO 1, Iconic EVO 1 27.5", Iconic EVO 2 27.5", Iconic EVO 3 27.5", Iconic EVO Belt 27.5",
Iconic EVO TR1 27.5"

23-15-2007 ... 23-15-2009, 23-15-2016 ... 23-15-2022, 23-15-3027, 23-15-3037

Contents

1	About these operating instructions	
1.1	Manufacturer	12
1.2	Laws, standards and directives	12
1.3	Language	12
1.4	For your information	12
1.4.1	Warnings	12
1.4.2	Markups	12
1.5	Aim of the operating instructions	13
1.6	Type number and model	14
1.7	Frame number	14
1.8	Identifying the operating instructions	14
2	Safety	
2.1	Residual risk	15
2.1.1	Risk of fire and explosion	15
2.1.2	Electric shock	17
2.1.3	Risk of a crash	17
2.1.4	Risk of amputation	17
2.1.5	Key breaking off	17
2.1.6	Malfunctions due to Bluetooth®	18
2.2	Toxic substances	19
2.2.1	Toxic substances	19
2.2.2	Irritants and corrosive substances	19
2.3	Requirements for the rider	19
2.4	Vulnerable groups	19
2.5	Personal protective equipment	20
2.6	Safety guards	20
2.7	Safety markings and safety instructions	20
2.8	What to do in an emergency	21
2.8.1	Dangerous situation in road traffic	21
2.8.2	Leaked brake fluid	21
2.8.3	Battery vapour emission	21
2.8.4	Battery fire	22
2.9	Data privacy information	23
3	Description	
3.1	Proper use	24
3.1.1	Pedelec type	24
3.1.2	Improper use	24
3.1.3	Maximum permitted total weight (PTW)	25
3.1.4	Environmental requirements	26
3.1.5	Area of use	26
3.2	Nameplate	28
3.3	Components	29
3.3.1	Overview	29
3.3.2	Chassis	30
3.3.2.1	Frame	30
3.3.2.2	Rear frame damper	33
3.3.2.3	Steering system	36
3.3.2.4	Steering headset	36
3.3.2.5	Stem	36
3.3.2.6	Handlebars	37
3.3.2.7	Suspension fork	37
3.3.3	Wheel	45
3.3.3.1	Tyres	45
3.3.3.2	Tube-type tyre	45

3.3.3.3	Rim	48
3.3.3.4	Valve	48
3.3.3.5	Spoke	48
3.3.3.6	Spoke nipples	48
3.3.3.7	Hub	49
3.3.4	Saddle	50
3.3.4.1	Ladies' saddle	51
3.3.4.2	Men's saddle	51
3.3.5	Seat post	52
3.3.5.1	Patent seat post	52
3.3.5.2	Suspension seat post	52
3.3.6	Brake	55
3.3.6.1	Mechanical brake	55
3.3.6.2	Hydraulic brake	55
3.3.6.3	Disc brake	56
3.3.7	Mechanical drive system	57
3.3.7.1	Chain drive layout	57
3.3.7.2	Belt drive layout	57
3.3.8	Electric drive system	58
3.3.8.1	Motor	58
3.3.8.2	Charger	58
3.3.8.3	Lighting	58
3.3.8.4	Rechargeable battery	59
3.3.9	On-board computer	60
3.3.10	Display	60
3.4	Description of controls and screens	61
3.4.1	Handlebars	61
3.4.2	BOSCH LED Remote on-board computer	62
3.4.2.1	System message	63
3.4.2.2	Creating a user account	64
3.4.2.3	Software updates	64
3.4.2.4	Activity tracking	64
3.4.2.5	Lock function	64
3.4.3	BOSCH display, Intuvia 100	65
3.4.3.1	Settings	66
3.4.4	Handbrake	67
3.4.5	Suspension and damping	68
3.4.5.1	Air valve and sag setting wheel	68
3.4.5.2	Damper adjuster	69
3.4.6	Battery level indicator (battery)	72
3.4.6.1	Battery level indicator (battery)	72
3.5	Technical data	73
3.5.1	Pedelec	73
3.5.2	Emissions	73
3.5.3	Bicycle lighting	73
3.5.4	Display BDS3YYY	73
3.5.5	LED Remote on-board computer	73
3.5.6	BOSCH Intuvia 100 display	73
3.5.6.1	BOSCH Performance Line CX motor	74
3.5.7	Rechargeable battery	74
3.5.7.1	BOSCH PowerTube 500 battery	74
3.5.7.2	BOSCH PowerTube 625 battery	74
3.5.7.3	BOSCH PowerTube 750 battery	74
3.5.7.4	BOSCH PowerPack 400 battery	74
3.5.7.5	BOSCH PowerPack 500 battery	75
3.5.7.6	BOSCH PowerPack 600 battery	75
3.5.7.7	BOSCH PowerPack 800 battery	75
3.5.8	Tyres	76
3.5.8.1	SCHWALBE puncture protection level	76

3.5.9	Saddle	77
3.5.9.1	BROOKS ENGLAND saddle width	77
3.5.9.2	ERGON	77
3.5.9.3	SELLE ROYAL saddle width	77
3.5.10	Seat post	78
3.5.10.1	Suspension seat post LIMOTEC, A3/A3 Plus	78
3.5.10.2	LIMOTEC seat post, A1/A1L	80
3.5.11	Torque	82
4	Transporting and storing	
4.1	Weight and dimensions for transportation	93
4.2	Designated handles, lifting points	93
4.3	Transportation	94
4.3.1	Using the transport securing system	94
4.3.2	Transporting the pedelec	94
4.3.2.1	By car	94
4.3.2.2	By train	94
4.3.2.3	By local transport	95
4.3.2.4	By long-distance bus	95
4.3.2.5	On flights	95
4.3.3	Shipping a pedelec	95
4.3.4	Transporting the battery	95
4.3.5	Shipping the battery	95
4.4	Storing	96
4.4.1	Pedelec	96
4.4.2	On-board computer, display and charger	96
4.4.3	Rechargeable battery	96
4.4.4	Break in operation	97
4.4.4.1	Preparing a break in operation	97
4.4.4.2	Carrying out a break in operation	97
5	Assembly	
5.1	Unpacking	98
5.2	Required tools	98
5.3	Commissioning	99
5.3.1	Checking the battery	99
5.3.2	Preparing the battery	100
5.3.2.1	Retrofitting the PowerTube adapter	100
5.3.2.2	Fit battery cover onto Bosch PowerTube 625 battery (horizontal)	101
5.3.2.3	Fit battery cover onto Bosch PowerTube 500 battery (horizontal)	102
5.3.3	Adjusting the suspension system to body weight	103
5.3.3.1	Adjusting SR SUNTOUR steel suspension fork to body weight	103
5.3.3.2	Adjusting seat post to body weight	103
5.3.4	Installing the wheel in the SUNTOUR fork	104
5.3.4.1	Screw-on axle (12AH2 and 15AH2)	104
5.3.4.2	20 mm cross axle	105
5.3.4.3	Q-LOC quick release	107
5.3.5	Preparing the wheel	108
5.3.6	Fitting the pedals	109
5.3.7	Preparing the LIMOTEC seat post	110
5.3.8	Checking the stem and handlebars	111
5.3.8.1	Checking the connections	111
5.3.8.2	Checking stem is firmly in position	111
5.3.8.3	Checking the bearing clearance	111
5.4	Selling the pedelec	111

6 Operation

6.1	Risks and hazards	112
6.2	Tips for a greater range	114
6.3	Error message	115
6.3.1	On-board computer	115
6.3.1.1	Less critical errors	115
6.3.1.2	Critical errors	115
6.3.2	Rechargeable battery	115
6.4	Instruction and customer service	116
6.5	Adjusting the pedelec	116
6.5.1	Preparing	116
6.5.2	Determining the sitting position	117
6.5.3	Seat post	118
6.5.3.1	Adjusting the seat post to body weight	118
6.5.4	Saddle	118
6.5.4.1	Replacing the saddle	118
6.5.4.2	Determining saddle shape	119
6.5.4.3	Determining minimum saddle width with corrugated cardboard	120
6.5.4.4	Determining minimum saddle width with gel cushion	120
6.5.4.5	Calculating the saddle width	121
6.5.4.6	Selecting the saddle hardness	121
6.5.4.7	Adjusting the saddle hardness	121
6.5.4.8	Straighten saddle	122
6.5.4.9	Adjusting the saddle height	122
6.5.4.10	Setting the saddle height with the remote control	123
6.5.4.11	Adjusting the saddle position	124
6.5.4.12	Adjusting the saddle tilt	124
6.5.4.13	Checking saddle stability	124
6.5.5	Handlebars	125
6.5.5.1	Replace handlebars	125
6.5.5.2	Adjusting the handlebar width	125
6.5.5.3	Adjusting the hand position	125
6.5.5.4	Adjusting the handlebars	126
6.5.6	Stem	127
6.5.6.1	Replacing the handlebars	127
6.5.6.2	Adjusting the handlebar height with quick release	127
6.5.6.3	Checking the stem stability	127
6.5.6.4	Adjusting the quick release clamping force	127
6.5.6.5	Setting the quill stem	128
6.5.6.6	Adjusting the Ahead stem	128
6.5.6.7	Adjusting the angle-adjustable stem	129
6.5.7	Handles	130
6.5.7.1	Replacing the handles	130
6.5.7.2	Adjusting ergonomic handles	130
6.5.7.3	Checking handlebar stability	130
6.5.8	Tyres	131
6.5.8.1	Replacing tyres	131
6.5.8.2	Adjust tyre pressure	131
6.5.9	Brake	133
6.5.9.1	Replacing brakes	133
6.5.9.2	Retracting the brake linings	133
6.5.9.3	Change handbrake position	133
6.5.9.4	Change handbrake inclination angle	134
6.5.9.5	Determining the grip distance	134
6.5.9.6	Grip distance on a SHIMANO ST-EF41 handbrake	135
6.5.10	Gear shift	136
6.5.10.1	Replacing the gear shift	136
6.5.10.2	Adjusting the SHIMANO shifter	136
6.5.11	Suspension and damping	137

6.5.12	Adjusting sag (fork)	137
6.5.12.1	Adjusting the sag for the SR SUNTOUR air suspension fork	139
6.5.12.2	Adjusting the sag for the SR SUNTOUR steel suspension fork	143
6.5.13	Adjust the rear frame damper sag	144
6.5.13.1	Adjusting Suntour sag for the rear frame damper	146
6.5.14	Fork rebound damping	148
6.5.14.1	Adjusting the SR SUNTOUR fork rebound damping	149
6.5.15	Adjusting the rear frame damper rebound damper	150
6.5.16	Setting high- and low-speed rebound damper in rear frame damper	150
6.5.16.1	Adjusting the Suntour rear frame damper	151
6.5.17	Riding light	152
6.5.17.1	Replacing the headlight	152
6.5.17.2	Replacing the rear light and (spoke) reflector	152
6.5.17.3	Setting the riding light	152
6.5.17.4	Adjusting the headlight	153
6.5.18	Adjusting the on-board computer	154
6.5.18.1	Creating a user account	154
6.5.18.2	Connecting the on-board computer to a smartphone	154
6.5.18.3	Updating the software	154
6.5.18.4	Activating activity tracking	154
6.5.18.5	Setting up the lock function (optional)	155
6.5.18.6	Inserting the battery	155
6.5.18.7	Inserting the display	156
6.5.18.8	Removing the on-board computer	156
6.5.18.9	Securing the on-board display (optional)	156
6.5.18.10	Adjusting the on-board computer	157
6.5.18.11	Adjust on-board computer	158
6.5.18.12	Selecting the language	158
6.5.18.13	Selecting units	158
6.5.18.14	Adjusting the clock	158
6.5.18.15	Setting the time format	158
6.5.18.16	Setting the shift recommendation	159
6.5.18.17	Adjusting the backlight	159
6.5.18.18	Setting the brightness	159
6.5.18.19	Resetting the settings	159
6.6	Accessories	160
6.6.1	Child seat	160
6.6.2	Trailer	161
6.6.2.1	Approval for trailer with Enviolo hub	161
6.6.2.2	Approval for trailer with ROHLOFF hub	162
6.6.3	Pannier rack	162
6.6.4	Panniers and cargo boxes	162
6.6.5	Front baskets	163
6.6.6	Bar ends	163
6.6.7	Kickstands	163
6.6.8	Additional battery headlight	163
6.6.9	Mobile holder	163
6.6.10	Suspension fork coil spring	163
6.6.11	Fixed weather protection systems	163
6.7	Personal protective equipment and accessories for road safety	164
6.8	Before each ride	164
6.9	Straightening the quickly adjustable stem	165
6.10	Using the pannier rack	165
6.11	Raising the kickstand	166
6.12	Using the saddle	166
6.12.1	Using the leather saddle	166
6.13	Using the pedals	166
6.14	Using the bell	166

6.15	Using the handlebars	167
6.15.1	Using multi-position handlebars	167
6.15.2	Using bar ends	167
6.15.3	Using leather handles	167
6.16	Use suspension and damping	168
6.16.1	Locking the suspension	168
6.16.1.1	Locking the SR SUNTOUR suspension fork	168
6.16.1.2	Locking the SR SUNTOUR rear frame damper	169
6.16.2	Adjusting the suspension fork compression damper	170
6.16.2.1	Using the SR Suntour low-speed compression damping	171
6.16.3	Adjusting the rear frame damper compression damper	172
6.16.3.1	Adjusting the SR Suntour compression damper	173
6.17	Using the battery	174
6.17.1	Removing the battery	174
6.17.1.1	Inserting the battery	174
6.17.2	Charging the battery	175
6.18	Using the electric drive system	176
6.18.1	Switching on the electric drive system	176
6.18.2	Switching off the electric drive system	176
6.19	Using the on-board computer	177
6.19.1	Using the diagnosis port	177
6.19.2	Charging the on-board computer battery	177
6.19.3	Using the riding light	178
6.19.4	Setting the brightness of indicators	178
6.19.5	Using the push assist system	178
6.19.6	Selecting the level of assistance	179
6.20	Brake	180
6.20.1	Using the brake lever	180
6.21	Gear shift	181
6.21.1	Using the derailleur gears	181
6.22	Parking	182
6.22.1	Screwing in the quickly adjustable stem	183
6.22.2	Activating the lock function	184

7 Cleaning, servicing and inspection

7.1	Before each ride	189
7.1.1	Checking the guards	189
7.1.2	Checking the frame	189
7.1.3	Checking the fork	189
7.1.4	Checking the rear frame damper	189
7.1.5	Checking the pannier rack	189
7.1.6	Checking the mudguards	189
7.1.7	Check wheel concentricity	189
7.1.8	Checking the quick releases	189
7.1.9	Checking the suspension seat post	190
7.1.10	Checking the bell	190
7.1.11	Checking the handles	190
7.1.12	Checking the USB cover	190
7.1.13	Checking the riding light	190
7.1.14	Checking the brake	190
7.2	After each ride	191
7.2.1	Cleaning the riding light and reflectors	191
7.2.2	Cleaning the suspension fork	191
7.2.3	Maintaining the suspension fork	191
7.2.4	Cleaning the pedals	191
7.2.5	Cleaning the brake	191
7.2.6	Cleaning the suspension seat post	191
7.2.7	Cleaning the rear frame damper	191

7.3	Basic cleaning	192
7.3.1	Clean on-board computer and control panel	192
7.3.2	Cleaning the battery	192
7.3.3	Cleaning the motor	192
7.3.4	Clean Frame, fork, pannier rack, guards and kickstand	193
7.3.5	Cleaning the stem	193
7.3.6	Cleaning the handlebars	193
7.3.7	Clean handles	193
7.3.7.1	Cleaning leather handles	193
7.3.8	Cleaning the seat post	193
7.3.9	Cleaning the saddle	194
7.3.9.1	Cleaning the leather saddle	194
7.3.10	Cleaning the tyres	194
7.3.11	Cleaning the spokes and spoke nipples	194
7.3.12	Clean hub	194
7.3.13	Cleaning the switching elements	194
7.3.13.1	Cleaning the shifter	194
7.3.14	Clean cassette, chain wheels and front derailleur	194
7.3.15	Clean brake	195
7.3.15.1	Clean handbrake	195
7.3.16	Cleaning the brake disc	195
7.3.17	Cleaning the belt	195
7.3.18	Cleaning the chain	195
7.3.18.1	Clean chain, including all-round chain guard	195
7.4	Maintenance	196
7.4.1	Maintain frame	196
7.4.2	Maintain fork	196
7.4.3	Maintain pannier rack	197
7.4.4	Maintain mudguard	197
7.4.5	Servicing the kickstand	197
7.4.6	Maintaining the stem	197
7.4.7	Maintaining the handlebars	197
7.4.8	Maintaining the handles	197
7.4.8.1	Maintaining the rubber handles	197
7.4.8.2	Maintaining the leather handles	197
7.4.9	Maintaining the seat post	198
7.4.9.1	Maintaining the suspension seat post	198
7.4.9.2	Maintaining the carbon seat post	198
7.4.10	Maintaining the rims	198
7.4.11	Maintaining the leather saddle	198
7.4.12	Maintaining the hub	198
7.4.13	Maintaining the spoke nipples	198
7.4.14	Maintaining the gear shift	199
7.4.14.1	Maintaining the rear derailleur articulated shafts and jockey wheel	199
7.4.14.2	Maintaining the shifter	199
7.4.15	Maintaining the pedals	199
7.4.16	Maintaining the chain	199
7.4.16.1	Maintaining the chain and all-round chain guard	200
7.4.17	Maintaining the battery	200
7.4.18	Maintaining the brake	200
7.4.18.1	Maintaining the handbrake	200
7.4.19	Lubricating the Eightpins seat post tube	200
7.5	Inspection	201
7.5.1	Checking the wheel	201
7.5.1.1	Checking tyre pressure	201
7.5.1.2	Checking the tyres	203
7.5.1.3	Checking the rims	204
7.5.1.4	Checking the nipple holes	204
7.5.1.5	Checking the nipple well	204

7.5.1.6	Checking the rim hooks	204
7.5.1.7	Checking the spokes	204
7.5.2	Checking the brake system	205
7.5.2.1	Checking the handbrake	205
7.5.2.2	Checking the hydraulic brake system	205
7.5.2.3	Checking the Bowden cables	205
7.5.2.4	Checking the disc brake	206
7.5.3	Checking the chain	207
7.5.4	Checking the chain tension	207
7.5.4.1	Check tension in derailleur gears	207
7.5.4.2	Check tension in hub gear	207
7.5.5	Checking the belt for wear	207
7.5.5.1	Rough check	207
7.5.5.2	Check	208
7.5.6	Checking the belt	209
7.5.7	Checking the belt for wear	209
7.5.8	Checking the belt sprockets for wear	209
7.5.9	Check belt tension	209
7.5.9.1	Gates Carbon Drive mobile app	210
7.5.9.2	Gates Krikrit tension meter	210
7.5.9.3	ECO tension tester	211
7.5.10	Checking the riding light	212
7.5.11	Checking the stem	213
7.5.12	Checking the handlebars	213
7.5.13	Checking the saddle	213
7.5.14	Checking the seat post	213
7.5.14.1	Checking the derailleur gears	213
7.5.14.2	Checking the hub gear	214
7.5.15	Check gear shift	214
7.5.15.1	Checking the electric gear shift	214
7.5.15.2	Check the mechanical gear shift	214
7.5.15.3	Checking the derailleur gears	215
7.5.16	Adjusting gear shift	215
7.5.16.1	Adjusting the ROHLOFF hub	215
7.5.17	Adjusting cable-operated gear shift, dual-cable	215
7.5.18	Adjusting Bowden-cable-operated twist grip, dual-cable	216
7.5.19	Checking kickstand stability	216

8 Inspection and maintenance

8.1	Initial inspection	217
8.2	Major inspection	217
8.3	Component-specific maintenance	217
8.4	Carry out initial inspection	220
8.5	Perform major inspection	221
8.5.1	Inspect frame	228
8.5.1.1	Inspecting the carbon frame	228
8.5.2	Inspecting the pannier rack	228
8.5.3	Inspecting and maintaining the rear frame damper	228
8.5.4	Inspecting the gear hub	229
8.5.4.1	Adjusting the hub with cone bearing	229
8.5.5	Inspecting the stem	229
8.5.6	Inspect and grease steering headset	229
8.5.7	Inspecting the axle with quick release	230
8.5.8	Inspecting the fork	231
8.5.8.1	Inspecting the carbon suspension fork	231
8.5.8.2	Inspecting the suspension fork	231
8.5.9	Inspecting the seat post	232
8.5.9.1	Inspecting the carbon seat post	232
8.5.9.2	Inspecting and greasing BY.SCHULZ suspension seat post	232
8.5.9.3	Inspecting and greasing RS SUNTOUR suspension seat post	233

9 Troubleshooting, fault clearance and repair

9.1	Preventing pain	234
9.1.1	Sitting discomfort	235
9.1.2	Pain in hips	235
9.1.3	Backache	235
9.1.4	Pain in shoulders and nape of neck	236
9.1.5	Numb or aching hands	236
9.1.6	Pain in upper thigh	236
9.1.7	Knee pain	237
9.1.8	Pain in the foot	237
9.2	Troubleshooting and fault clearance	238
9.2.1	Drive system or on-board computer does not start up	238
9.2.2	Errors in assistance function	239
9.2.3	Battery errors	240
9.2.4	Display screen errors	241
9.2.5	Lighting does not work	241
9.2.6	Problems with disc brakes	242
9.2.7	Problems with freewheel	243
9.2.8	Problem with SR SUNTOUR suspension fork	244
9.2.8.1	Rebound too fast	244
9.2.8.2	Rebounding too slowly	245
9.2.8.3	Suspension too soft on inclines	246
9.2.8.4	Excessively hard damping on bumps	247
9.2.9	Problems with SR SUNTOUR rear frame damper	248
9.2.9.1	Rebound too fast	248
9.2.9.2	Rebounding too slowly	249
9.2.9.3	Suspension too soft on inclines	250
9.2.9.4	Excessively hard damping on bumps	251
9.2.10	Lighting does not work	252
9.2.11	Problems with the tyres	252
9.2.12	Problems with the seat post	252
9.3	Other errors	253
9.4	Repair	254
9.4.1	Original parts and lubricants	254
9.4.2	Repairing the frame	254
9.4.2.1	Removing paint damage on frame	254
9.4.2.2	Removing damage from impact on the carbon frame	254
9.4.3	Repairing the suspension fork	254
9.4.3.1	Removing paint damage on the fork	254
9.4.3.2	Removing damage from impact on the carbon frame	254
9.4.3.3	Repairing the seat post	254
9.4.3.4	Repairing damage from impact on the carbon seat post	254
9.4.4	Replacing the riding light	255
9.4.5	Adjusting the headlight	255
9.4.6	Checking suspension fork-tyre clearance	255
9.4.7	Replacing pedelec components if lock function is installed	256
9.4.7.1	Replacing a smartphone	256
9.4.7.2	Replacing the on-board computer	256
9.4.7.3	Activating the lock function after motor replacement	256

10	Recycling and disposal	
10.1	Guidelines on removal of waste	257
11	Documents	
11.1	Assembly report	259
11.2	Inspection and maintenance log	261
11.3	Parts list	265
11.3.1	Cross Rider Evo 1	265
11.3.2	Iconic EVO 1	268
11.3.3	Iconic EVO 2	271
11.3.4	Iconic EVO 3	274
11.3.5	Iconic EVO Belt	277
11.3.6	Iconic EVO TR1	280
11.4	Charger operating instructions	283
12	Glossary	
12.1	Abbreviations	293
12.2	Simplified terms	293
13	Appendix	
I.	Translation of the original EC/EU Declaration of Conformity	294
II.	Directive declaration of conformity with RED Directive	295
II.	CE Declaration of Conformity	295
14	Keyword index	

Thank you for your trust!

BULLS *pedelecs* are premium quality vehicles. You have made an excellent choice. Your specialist dealer will provide you with guidance and instruction and assemble your product. Your specialist dealer will also be happy to assist you in the future, whether you require an inspection, retrofit or repair.

You are receiving these operating instructions with your new pedelec. Please take time to become familiar with your new pedelec. Use the tips and suggestions in the operating instructions. They will help you to enjoy your pedelec for a long time to come. We hope you have fun and wish you well on all of your rides!

Download the operating instructions onto your phone at the following link, so that you can use them when you are out riding:



www.bulls.de/service/downloads.

Copyright

© ZEG Zweirad-Einkaufs-Genossenschaft eG

Distribution or reproduction of these operating instructions and utilisation or communication of their content is prohibited unless expressly approved. Anyone who does not comply with these restrictions is liable for compensation. All rights reserved in the event that a patent, utility model or industrial design is registered.

Subject to internal changes

The information contained in these *operating instructions* are the approved technical specifications at the time of printing. In addition to the functions described here, the software may be modified at any time to rectify errors and extend functions.

Any significant changes are included in a new published version of the operating instructions. All changes and new versions of the operating instructions are published on the following website:

www.bulls.de/service/downloads.

Editing

Text and images:
ZEG Zweirad-Einkaufs-Genossenschaft eG
Longericher Strasse 2
50739 Köln, Germany

Translation

RKT Übersetzungs- und Dokumentations-GmbH
Bahnhofstrasse 27
78713 Schramberg
Germany

If you have any questions or problems regarding these operating instructions, please contact:

tecdoc@zeg.de

1 About these operating instructions

1.1 Manufacturer

ZEG Zweirad-Einkaufs-Genossenschaft eG
Longericher Strasse 2
50739 Köln, Germany

Tel.: +49 221 17959 0
Fax: +49 221 17959 31
Email: info@zeg.de

1.2 Laws, standards and directives

The *operating instructions* comply with the essential requirements specified in:



- Machinery Directive 2006/42/EC
- Electromagnetic Compatibility Directive 2014/30/EU
- ISO 20607:2018 Safety of machinery– Operating instructions– General drafting principles
- EN 15194:2018 Cycles – Electrically power assisted cycles – pedelec bicycles
- EN 11243:2016, Cycles – Luggage carriers for bicycles – Requirements and test methods
- ISO 17100:2016-05 Translation Services – Requirements for translation services.

1.3 Language

The *original operating instructions* are written in German. A translation is invalid without the *original operating instructions*.

1.4 For your information

Different markings are used in the operating instructions to make them easier to read.

	Text for specialist dealers
	Notice on replacing components
	Notice on fitness

1.4.1 Warnings

Warnings indicate hazardous situations and actions. You will find three categories of warnings in the operating instructions:



May lead to serious or even fatal injuries if ignored. Medium-risk hazard.



May lead to minor or moderate injuries if ignored. Low-risk hazard.

Notice

May lead to material damage if ignored.

1.4.2 Markups

You will find ten text markups in the *operating instructions*:

Stylised form	Use
<i>Italics</i>	Glossary term, first mention in section
<u>Underlined in blue</u>	Link
<u>Underlined in grey</u>	Cross references
✓	Requirements
▶	Instructions for actions without specific order
3	Instructions for actions in specified order
⇒	Result of the action
SPACED	Indicators on the display screen
•	Bulleted lists
<i>Only applies to pedelecs with this equipment</i>	A note beneath the heading indicates components which can be used as an option

Table 1: Markups

1.5 Aim of the operating instructions

These operating instructions are not a substitute for personal instruction by the specialist dealer supplying the bike. These operating instructions are an integral part of the pedelec. Therefore, if it is re-sold at a later time, they must be handed over to the subsequent owner.

These operating instructions are mainly written for people riding pedelecs.

Paragraphs with a white background are intended to enable non-professionals to make safe settings on the pedelec, use it, clean it and identify and eliminate any faults.



Sections intended for technical staff are highlighted in blue and marked with a spanner symbol.

These sections aim to allow trained technical staff (bicycle mechatronics engineers, bicycle mechanics or others) to carry out initial assembly, adjustment, inspection and repair safely.

Technical staff also need to read all sections for pedelec riders and operators to ensure they can provide better customer service.

Always fill out all reports in Section 11.1 and Section 11.2 when carrying out work.

Section		Rider	Specialist dealer
1	About these operating instructions	<input type="checkbox"/>	<input type="checkbox"/>
2	Safety	<input type="checkbox"/>	<input type="checkbox"/>
3	Description	<input type="checkbox"/>	<input type="checkbox"/>
4	Transporting and storing	<input type="checkbox"/>	<input type="checkbox"/>
5	Assembly	<input type="checkbox"/>	<input type="checkbox"/>
6	Operation	<input type="checkbox"/>	<input type="checkbox"/>
7	Cleaning, servicing and inspection	<input type="checkbox"/>	<input type="checkbox"/>
8	Inspection and maintenance	<input type="checkbox"/>	<input type="checkbox"/>
9.1	Preventing pain	<input type="checkbox"/>	<input type="checkbox"/>
9.2	Troubleshooting and fault clearance	<input type="checkbox"/>	<input type="checkbox"/>
9.3	Repair	<input type="checkbox"/>	<input type="checkbox"/>
10	Recycling and disposal	<input type="checkbox"/>	<input type="checkbox"/>
11	Documents	<input type="checkbox"/>	<input type="checkbox"/>
12	Glossary	<input type="checkbox"/>	<input type="checkbox"/>
13	Appendix	<input type="checkbox"/>	<input type="checkbox"/>
14	Keyword index	<input type="checkbox"/>	<input type="checkbox"/>

Table 2: Target groups-section matrix

1.6 Type number and model

These operating instructions are an integral part of pedelecs with the type numbers:

Type no.	Model	Pedelec type
23-15-2007	Cross Rider EVO 1 (Gent)	City and trekking bicycle
23-15-2008	Cross Rider EVO 1 (Trapez)	City and trekking bicycle
23-15-2009	Cross Rider EVO 1 (Wave)	City and trekking bicycle
23-15-2016	Iconic EVO 1 27.5" (Gent)	City and trekking bicycle
23-15-2017	Iconic EVO 1 27.5" (Wave)	City and trekking bicycle
23-15-2018	Iconic EVO 2 27.5" (Gent)	City and trekking bicycle
23-15-2019	Iconic EVO 2 27.5" (Wave)	City and trekking bicycle
23-15-2020	Iconic EVO 3 27.5" (Gent)	City and trekking bicycle
23-15-2021	Iconic EVO 3 27.5" (Wave)	City and trekking bicycle
23-15-3027	Iconic EVO Belt 27.5" (Gent)	City and trekking bicycle
23-15-3037	Iconic EVO Belt 27.5" (Wave)	City and trekking bicycle
23-15-2022	Iconic EVO TR1 27.5"	City and trekking bicycle

Table 3: Type number, model and pedelec type

1.7 Frame number

Each frame has an individual frame number stamped on it (see Figure 3). The frame number can be used to associate the pedelec with the owner. The frame number is the most important identifier for verifying ownership.

1.8 Identifying the operating instructions

The operating instructions identification number is located in bottom left-hand corner of each page.

The identification number is composed of the document number, the version number and the release date.

Identification number	MY23B0a - 52_1.0_31.08.2022
------------------------------	-----------------------------

2 Safety

2.1 Residual risk

Pedelecs pose the following residual risks:

- Risk of fire and explosion
- Electric shock
- Risk of a crash
- Risk of amputation
- Key breaking off
- Malfunctions due to Bluetooth®



2.1.1 Risk of fire and explosion

Never charge if there is a critical fault

If a charger is connected to the drive system when a critical error is reported, the battery may be damaged permanently and may catch fire.

- ▶ Connect charger to fault-free electric drive system only.

Protect against penetrating water

The battery is only protected from spray water. Penetration by water can cause a short circuit. The battery may self-ignite and explode.

- ▶ Never immerse battery in water.
- ▶ Take battery out of service if you suspect water has penetrated it.

Avoid heat

Temperatures over 60 °C can also cause liquid to leak from the battery and the battery will become damaged. The battery may self-ignite and explode.

- ▶ Protect the battery against heat.
- ▶ Never store next to hot objects.
- ▶ Never expose battery to continuous direct sunlight.
- ▶ Avoid wide temperature fluctuations.

Never use incorrect charger

Chargers with excessive voltage damage batteries. This may cause a fire or an explosion.

- ▶ Only use approved batteries to charge.

Prevent short circuit due to interconnection

Metal objects may interconnect the battery's electrical terminals. The battery may self-ignite and explode.

- ▶ Never insert paper clips, screws, coins, keys and other small parts into the battery.
- ▶ Place the battery on clean surfaces only. Prevent charging socket and contacts against contamination from dirt, sand and similar.

Handling a damaged or faulty battery

Faulty batteries are hazardous goods. These include

- Cells or batteries which have been identified as faulty for safety reasons
- Leaked batteries or which have released gas
- Cells or batteries which have sustained external or physical damage
- Cells or batteries whose safety has not been tested yet

The safety electronics may fail if the batteries are damaged or faulty. The residual voltage can cause a short circuit. The battery may self-ignite and explode.

- ▶ Only use and charge the battery and accessories if they are in perfect condition.
- ▶ Never open or repair the battery.
- ▶ Batteries with external damage must be removed from service immediately.
- ▶ If a battery is dropped or struck, remove it from service and keep it under observation for at least 24 hours.
- ▶ Contact specialist dealer.

Storing faulty batteries

Your specialist dealer will dispose of faulty batteries.

- ▶ Take faulty batteries to your specialist dealer.



- ▶ Store the battery in a safety container in a dry place as per special regulations (ADR SV 376, P908) until you dispose of it.



Figure 1: Example of a safety container

- ▶ Never store near flammable substances.
- ▶ Dispose of faulty batteries in the correct manner.

Avoid overheating in the charger

The charger heats up when charging the battery. If the battery is not allowed to cool down sufficiently, it can cause a fire or burns to the hands.

- ▶ Never use charger on a highly flammable surface.
- ▶ Never cover the charger during charging.
- ▶ Never leave battery unattended during charging.

Cool down overheated brakes and motors

The brakes and the motor may become very hot during operation. There is a risk of burns or fire in case of contact.

- ▶ Never touch the brakes or the motor immediately after a ride.
- ▶ Never place the pedelec on a flammable surface, such as grass or wood, directly after use.



2.1.2 Electric shock

Never use damaged network components

Damaged chargers, cables and plug connectors increase the risk of electric shock.

- ▶ Check the charger, cable and plug connector before each use. Never use a damaged charger.

Avoid water penetrating

If water penetrates into the charger, there is a risk of electric shock.

- ▶ Use the charger indoors only.

Dealing with condensate

Condensation may form in the charger and in the battery when the temperature changes from cold to hot, causing a short circuit.

- ▶ Wait until both charger and battery are at room temperature before connecting them.



2.1.3 Risk of a crash

Set the quick release correctly

Excessively high clamping force will damage the quick release and cause it to lose its function. Insufficient clamping force will result in unfavourable transmission of force. This can cause components to break. This will cause a crash with injuries.

- ▶ Never fasten a quick release using a tool (e.g. hammer or pliers).
- ▶ Only use the clamping lever with the specified set clamping force.

Use correct torque

If a screw is fastened too tightly, it may break. If a screw is not fastened enough, it may loosen. This will cause a crash with injuries.

- ▶ Always observe the indicated tightening torque on the screw or in Section 3.5.11.

Use approved brakes only

The wheels are designed exclusively for use with rim brakes or disc brakes. The wheel may break if an incorrect brake is used. This will cause a crash with injuries.

- ▶ Only use the approved brakes on the wheel.



2.1.4 Risk of amputation

The brake disc in disc brakes is so sharp that it can cause serious injuries to fingers if they are inserted into the brake disc openings.

The chain wheels and belt sprockets can draw in fingers, thus causing serious injuries to fingers.

- ▶ Always keep fingers well away from rotating brake discs and the chain or belt drive.

2.1.5 Key breaking off

If you leave a key inserted when riding or transporting the pedelec, it may break off or the locking system may open accidentally.

- ▶ Pull the key from the battery lock.

2.1.6 Malfunctions due to Bluetooth®

If you use the on-board computer with Bluetooth® and/or Wi-Fi®, it may cause interference with other devices, other equipment, aircraft, and medical devices, such as pacemakers and hearing aids.

Likewise, it cannot be completely ruled out that you will cause harm to people and animals in the immediate vicinity.

- ▶ Never use the pedelec with Bluetooth® when in close proximity to medical devices, filling stations, chemical plants, areas at risk of explosion and in blasting zones.
- ▶ Never use pedelec with Bluetooth® in aircraft.
- ▶ Avoid operating for longer periods in close proximity to the body.

2.2 Toxic substances

If substances are released or used which pose a risk to people and the environment, effective protective measures must be taken.

Possible hazards, contamination and health hazards due to:

- Carcinogenic, germ-cell-mutagenic and reproduction-toxic substances
- Toxic substances
- Irritants (skin, respiratory system) and corrosive substances

What might happen?

- Serious harmful effects to health
- Threat to life
- Hazard to bystanders due to carry-over and contamination, including in personal sphere.



2.2.1 Toxic substances

Toxic substances (also known as poison or toxins) refer to substances which can cause damage to living beings if they enter the organism above a specific low dose. The more the ingested amount of a toxic substance increases, the greater the likelihood of damage to health due to poisoning is. This can lead to death.

Brake fluid

Brake fluid may leak out after an accident or due to material fatigue. Brake fluid can be fatal if swallowed or inhaled.

- ▶ Never dismantle the brake system.
- ▶ Avoid contact with skin.
- ▶ Do not inhale vapours.



2.2.2 Irritants and corrosive substances

Corrosive substances (also known as corrosives) destroy living tissue or attack surfaces. Corrosive substances may be in solid, liquid or gaseous form.

Irritants are hazardous substances which irritate the skin and mucous membranes once you come into contact with them. This may cause inflammation of the affected areas.

Defective battery

Liquids and vapours may leak from damaged or faulty batteries. Excessively high temperatures may also cause liquids and vapours to leak from the battery. Such liquids and vapours can irritate the airways and cause burns.

- ▶ Never dismantle the battery.
- ▶ Avoid contact with skin.
- ▶ Never inhale vapours.

2.3 Requirements for the rider

The rider must have adequate physical, motor and mental abilities to ride on public roads. A minimum age of 14 years is recommended.

2.4 Vulnerable groups

- ▶ Keep batteries and the charger away from children and people with reduced physical, sensory or mental capacities or lacking in experience and knowledge.
- ▶ Children and young people must be provided with comprehensive instructions by a legal guardian.

2.5 Personal protective equipment

- ▶ Wear a suitable helmet. The helmet must have a reflective strip or a light in a clearly visible colour.
- ▶ Wear sturdy shoes.
- ▶ Wear clothing which is as bright or retroreflective as possible. Fluorescent materials are also suitable. High-visibility jackets and straps on your upper body ensure even greater safety. Never wear a skirt. Always wear trousers which reach down to your ankles instead.
- ▶ Wear gloves when it is cold.

2.6 Safety guards

Three safety guards on the pedelec protect riders against heat or moving parts:

- Chain or belt guards prevent clothing from being pulled into the drive train.
 - The motor cover on the motor casing protects against heat.
 - Mudguards protect against dirt and water splashing up from the road
- ▶ Never remove the guards.
 - ▶ Check the guards on a regular basis.
 - ▶ Take pedelec out of service if a guard is damaged or missing. Contact specialist dealer.

2.7 Safety markings and safety instructions

Pedelec and battery nameplates contain the following safety markings and safety instructions:



Symbol	Explanation
	General warning
	Adhere to the instructions for use

Table 4: Safety markings











Symbol	Explanation
	Read the instructions
	Separate collection of electrical and electronic devices
	Separate collection of ordinary and rechargeable batteries
	Must not be thrown into fire (burning prohibited)
	It is forbidden to open any batteries
	Device of protection class II
	Only suitable for use indoors
	Fuse (device fuse)
	EU conformity
	Recyclable material
	Protect from temperatures above 50 °C and direct sunlight

Table 5: Safety instructions

2.8 What to do in an emergency

2.8.1 Dangerous situation in road traffic

- ▶ If you encounter any hazards or dangers in road traffic, apply the brake on the pedelec until it comes to a halt. The brake acts as an emergency stop system in such cases.

2.8.2 Leaked brake fluid

- ▶ Remove those affected from the danger area to fresh air.
- ▶ Never leave those affected unattended.
- ▶ Immediately remove any clothing items contaminated with brake fluid.
- ▶ Never inhale vapours. Ensure sufficient ventilation.
- ▶ Wear gloves and safety glasses as protective equipment.
- ▶ Keep unprotected persons away.
- ▶ Take care with leaked brake fluid as it poses a slip hazard.
- ▶ Keep leaked brake fluid away from naked flames, hot surfaces and sources of ignition.
- ▶ Avoid contact with skin and eyes.

If inhaled

- 1 Take in fresh air.
- 2 Immediately consult a doctor in case of any discomfort.

After skin contact

- 1 Wash affected skin with soap and water and rinse well.
- 2 Remove contaminated clothing.
- 3 Consult doctor in the event of pain or discomfort.

After contact with eyes

- 1 Rinse eyes under flowing water for at least ten minutes with the lids open; also rinse under lids.
- 2 Immediately consult a doctor in case of any pain or discomfort.

If swallowed

- 1 Rinse out mouth with water. Never induce vomiting. Risk of aspiration.
- 2 If a person is lying on their back and vomiting, place them in the recovery position.
- 3 Seek medical advice immediately.

Environmental protection measures

- ▶ Never allow brake fluid to flow into sewage, water courses or groundwater.
- ▶ Notify the relevant authorities if fluid penetrates the ground, water courses or the sewage system.
- ▶ Dispose of leaked brake fluid in an environmentally responsible way in accordance with statutory regulations (see Section 10.1).
- ▶ The brake system must be repaired immediately if brake fluid leaks out. Contact specialist dealer.

2.8.3 Battery vapour emission

Vapours may be emitted if the battery is damaged or used improperly. The vapours may cause respiratory tract irritation.

- 1 Get into fresh air.
- 2 Consult doctor in the event of pain or discomfort.

After contact with eyes

- 1 Carefully rinse eyes with plenty of water for at least 15 minutes. Protect unaffected eye.
- 2 Seek medical advice immediately.

After skin contact

- 1 Remove any solid particles immediately.
- 2 Remove contaminated clothing immediately.
- 3 Rinse the affected area with plenty of water for at least 15 minutes.
- 4 Then dab the affected skin gently. Do not rub dry.
- 5 Immediately consult a doctor if there is any redness, pain or discomfort.

2.8.4 Battery fire

The safety electronics may fail if the battery is damaged or faulty. The residual voltage can cause a short circuit. The battery may self-ignite and explode.

- 1 Keep your distance if the battery becomes deformed or starts to emit smoke.
 - 2 If charging, remove the plug connector from the socket.
 - 3 Contact the fire service immediately.
- ▶ Use Class fire extinguishers to put out the fire.
 - ▶ Never extinguish damaged batteries with water or allow them to come into contact with water.

Inhaling vapours can cause intoxication.

- ▶ Stand on the side of the fire where the wind is blowing from.
- ▶ Use breathing apparatus if possible.

2.9 Data privacy information

When the pedelec is connected to the diagnosis tool at the specialist dealer's, data is transferred to BOSCH eBike Systems (Robert Bosch GmbH) on the use of the Bosch drive unit, including its energy consumption and temperature, to help improve the product.

You will find more information on the Bosch eBike website:

www.bosch-ebike.com.

3 Description

3.1 Proper use

All checklists and instructions for actions in these operating instructions met. Approved accessories can be installed by specialist staff.

Use the pedelec when it is in perfect, proper working order only. National requirements may apply to the pedelec which the standard equipment may not meet. Different regulations apply across the country to the riding light,

reflectors and other components when riding on public roads. The general laws and the regulations for the prevention of accidents and environmental protection in the respective country of use must be adhered to.

The rechargeable batteries are designed to supply power to the pedelec motor only. Never use the batteries for other purposes.

3.1.1 Pedelec type

Each pedelec is assigned a pedelec type, which determines its proper use, function and area of use.



City and trekking bicycle	Folding bicycle
	
City and trekking bicycles are designed for comfortable, daily use and are suitable for riding on public roads.	Folding bicycles are suitable for riding on public roads. Folding bikes can be folded together and thus save space when they are transported, e.g. in cars or on local transport. The folding bicycle's folding design requires the use of smaller wheels and longer brake cables and Bowden cables. With increased strain, you should therefore expect a reduction in riding stability, braking power, comfort and durability.

Table 6: Proper use

3.1.2 Improper use

Failure to adhere to the proper use poses a risk of personal injury and material damage. It is prohibited to use the pedelec in the following ways:

- when the electrical drive system been manipulated
- changing, eliminating or effacing frame numbers, nameplates or component serial numbers, or manipulating them in any other way
- riding with a damaged or incomplete pedelec
- riding over steps
- riding through deep water
- charging with an incorrect charger
- lending the pedelec to untrained pedelec rider
- carrying other people
- riding with excessive baggage
- riding with no hands
- riding on ice and snow
- improper servicing
- improper repair

- tough areas of use, such as professional competitions
- acrobatics, riding up ramps, stunt riding or flying stunts.



City and trekking bicycle	Folding bicycle
	
City and trekking bicycles are not sports bicycles. If used for sports, the rider can expect reduced riding stability and diminished comfort.	A folding bicycle is not a touring or sports bicycle. When riding longer distances or using the bike for sports, the rider can expect reduced riding stability and diminished comfort.

Table 7: IMPROPER USE

3.1.3 Maximum permitted total weight (PTW)

The pedelec may only be loaded to its *maximum permitted total weight* (PTW).

The maximum permitted total weight is

- the weight of the fully assembled pedelec
- plus body weight
- plus baggage

Type no.	Model	PTW [kg]
23-15-2007	Cross Rider EVO 1 (Gent)	150
23-15-2008	Cross Rider EVO 1 (Trapez)	150
23-15-2009	Cross Rider EVO 1 (Wave)	150
23-15-2016	Iconic EVO 1 27.5" (Gent)	135
23-15-2017	Iconic EVO 1 27.5" (Wave)	135
23-15-2018	Iconic EVO 2 27.5" (Gent)	135
23-15-2019	Iconic EVO 2 27.5" (Wave)	135
23-15-2020	Iconic EVO 3 27.5" (Gent)	150
23-15-2021	Iconic EVO 3 27.5" (Wave)	150
23-15-3027	Iconic EVO Belt 27.5" (Gent)	135
23-15-3037	Iconic EVO Belt 27.5" (Wave)	135
23-15-2022	Iconic EVO TR1 27.5"	#

Table 8: Type number, model and PTW

3.1.4 Environmental requirements

You can be ride the pedelec within a temperature range between -5 °C and +40 °C. The electric drive system is limited in its performance outside this temperature range.

Operating temperature	-5 ... +40 °C
-----------------------	---------------

During winter use, especially at temperatures below 0 °C, we recommend that you don't insert a battery charged and stored at room temperature into the pedelec until just before setting off. We recommend using thermal protection sleeves when riding longer distances at low temperatures.

Temperatures under -10 °C and over +60 °C must be avoided as a general rule. Never put the battery in a car in summer or store it in direct sunlight.

You must also keep within the following temperature ranges:

Transportation temperature	+10 ... +40 °C
Storage temperature	+10 ... +40 °C
Work environment temperature	+15 ... +25 °C
Charging temperature	+10 ... +40 °C

The nameplate contains symbols for the pedelec's area of use.

- Check what tracks and roads you may ride on before setting off for the first time.

3.1.5 Area of use











Area of use	City and trekking bicycles	Child's bicycles/ bicycles for young adults	Mountain bikes	Racing bicycle	Cargo bike	Folding bicycle
 1	 Suitable for tarmacked and paved roads.	 Suitable for tarmacked and paved roads.		 Suitable for tarmacked and paved roads.	 Suitable for tarmacked and paved roads.	 Suitable for tarmacked and paved roads.
 2	Suitable for tarmacked roads, cycle paths, firm gravel paths and roads, and longer sections with moderate slopes and jumps up to 15 cm.	Suitable for tarmacked roads, cycle paths, firm gravel paths and roads, and longer sections with moderate slopes and jumps up to 15 cm.	Suitable for tarmacked roads, cycle paths, firm gravel paths and roads, and longer sections with moderate slopes and jumps up to 15 cm.	Suitable for tarmacked roads, cycle paths, firm gravel paths and roads, and longer sections with moderate slopes and jumps up to 15 cm.		
 3		Suitable for tarmacked roads, cycle paths and easy to demanding off-road riding, sections with moderate slopes and jumps up to 61 cm.	Suitable for tarmacked roads, cycle paths and easy to demanding off-road riding, sections with moderate slopes and jumps up to 61 cm.			
 4			Suitable for tarmacked roads, cycle paths and easy to demanding off-road riding, limited downhill use and jumps up to 122 cm.			

Table 9: Area of use

The pedelec is unsuitable for the following areas of use:











Area of use	City and trekking bicycles	Child's bicycles/ bicycles for young adults	Mountain bikes	Racing bicycle	Cargo bike	Folding bicycle
 1	 Never drive off-road or perform jumps.	 Never drive off-road or perform jumps.		 Never drive off-road or perform jumps.	 Never drive off-road or perform jumps.	 Never drive off-road or perform jumps.
 2	Never drive off-road or perform jumps over 15 cm.	Never drive off-road or perform jumps over 15 cm.	Never drive off-road or perform jumps over 15 cm.	Never drive off-road or perform jumps over 15 cm.		
 3		Never ride downhill or perform jumps over 61 cm.	Never ride downhill or perform jumps over 61 cm.			
 4			Never traverse extremely difficult off-road terrain or perform jumps over 122 cm.			

Table 10: Unsuitable terrain

3.2 Nameplate

The nameplate is situated on the frame. The precise position of the nameplate is shown in Figure 3.

The nameplate contains up to twelve pieces of information.

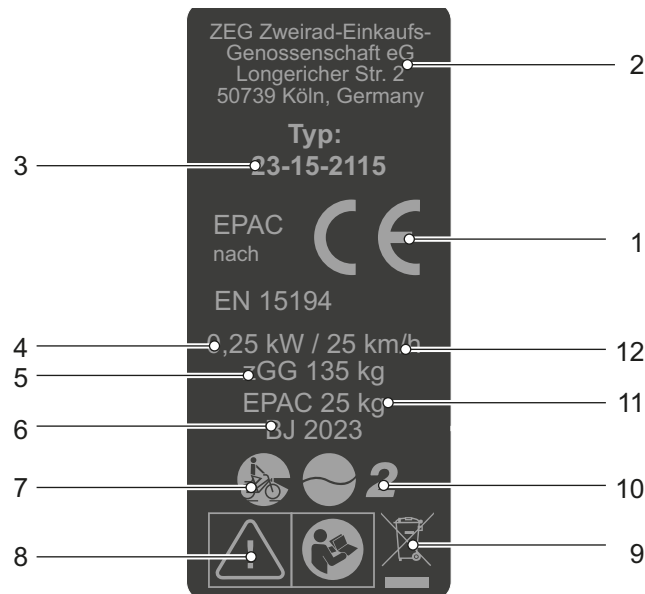

Figure 2: Example of ZEG nameplate

No.	Designation	Description	More information
1	CE marking	The manufacturer uses the CE marking to declare that the pedelec complies with applicable requirements.	Appendix
2	Manufacturer	You can contact the manufacturer at the address indicated.	Section 1.1
3	Type number	All pedelec models have an eight-digit type number, which is used to specify the design model year, the type of pedelec and the version.	Section 1.6
4	Maximum continuous power rating	The maximum continuous power rating is the maximum possible power for the electric motor output shaft over 30 minutes.	...
5	Maximum permitted total weight (PTW)	The maximum permitted total weight is the weight of the fully assembled pedelec with the body weight plus the baggage.	Section 3.1.3
6	Year of manufacture	The year of manufacture is the year in which the pedelec was manufactured.	...
7	Pedelec type	Each pedelec is assigned a pedelec type, which determines its proper use, function and area of use.	Section 3.1.1
8	Safety markings	Safety markings warn of hazards.	Section 2.7
9	Disposal instructions	Follow the guidelines on waste disposal when disposing of the pedelec.	Section 10.1
10	Area of use	Ride pedelec in permitted locations only.	Section 3.1.5
11	Weight of the ready-to-ride pedelec (optional; only for pedelecs 25 kg or more)	The weight of the ready-to-ride pedelec is specified as a weight of 25 kg or above and refers to its weight at the time of purchase. Any extra accessories need to be added to the weight.	Section 4.1
12	Shut-off speed	The speed that the pedelec reaches at the moment when the current has dropped to zero or to the no-load current value.	...

Table 11: Explanation of information on the nameplate

3.3 Components

3.3.1 Overview

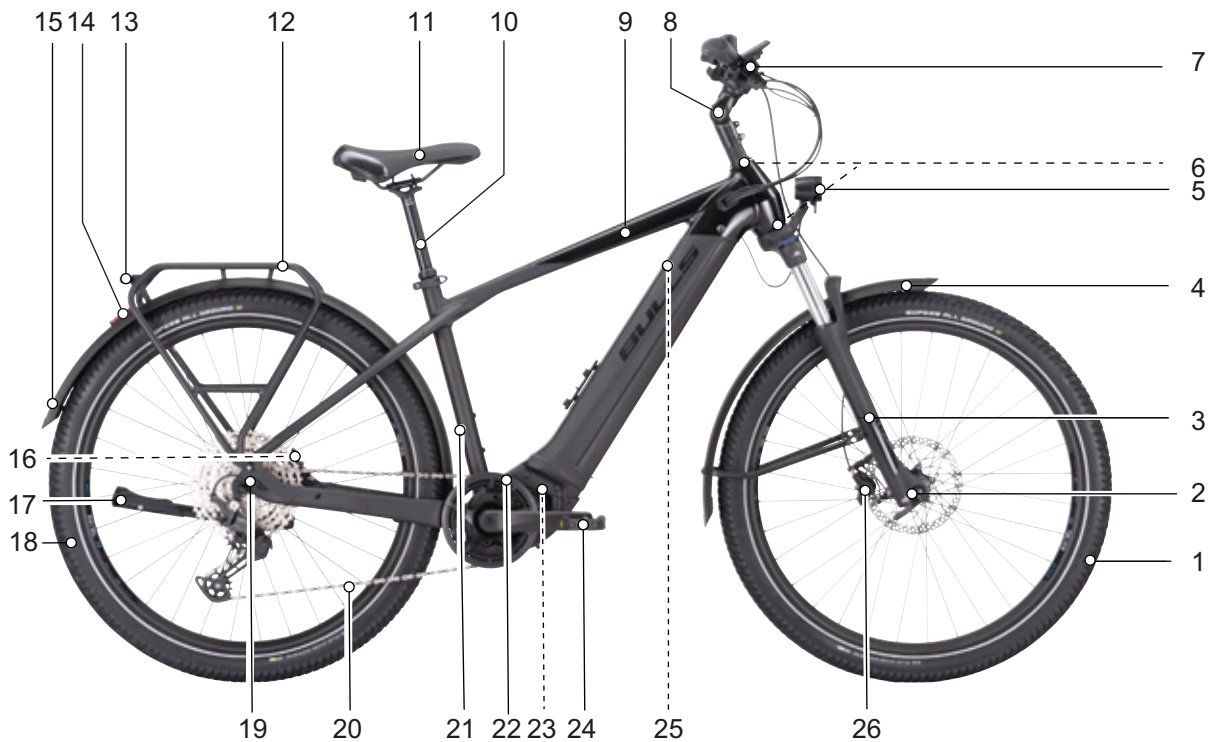

Figure 3: Pedelec viewed from right, Cross Rider EVO 2 used as example

1	Wheel	10	Seat post	19	Hub
2	Hub	11	Saddle	20	Chain
3	Suspension fork	12	Pannier rack	21	Frame number
4	Mudguard	13	Rear light	22	Chain guard
5	Front light	14	Reflector	23	Motor
6	Steering headset	15	Guard	24	Pedal
7	Handlebars	16	Rear wheel brake	25	Rechargeable battery
8	Stem	17	Kickstand	25	Nameplate
9	Frame	18	Wheel	26	Front wheel brake

3.3.2 Chassis

The chassis comprises two components:

- Frame and
- steering system

3.3.2.1 Frame

The frame absorbs all forces which act on pedelec from body weight, pedalling and the ground. The frame also acts as a carrier for most components.

The frame geometry determines the pedelec's ride performance. A frame comprises the following elements:

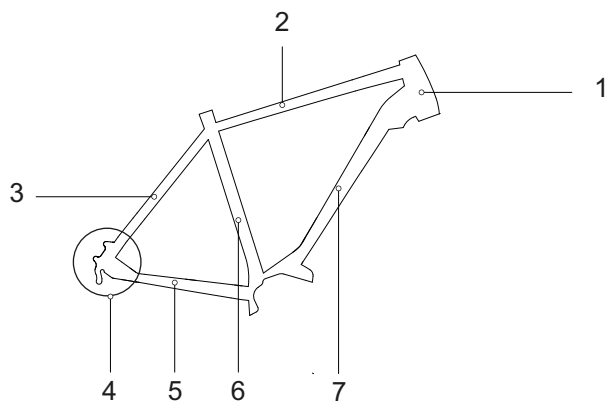

Figure 4: Elements of the frame

- | | |
|---|----------------------|
| 1 | Head tube |
| 2 | Top tube |
| 3 | Rear frame seat stay |
| 4 | Rear frame fork end |
| 5 | Chain stay |
| 6 | Seat tube |
| 7 | Down tube |

Spring-loaded frames also feature a rear frame damper (see Section 3.3.2.2).

Carbon frame

Carbon (CFRP) is a carbon-fibre-reinforced polymer made of high-strength, rigid fibres. Carbon frames comprise several layers of carbon with an epoxy resin matrix. The uppermost layer is known as the visible layer.

Benefits

- Carbon frames are more rigid than aluminium and offer greater fatigue strength.
- Rustproof carbon frame.
- If carbon frames are fitted correctly and are not involved in a serious accident, they have a similar long life cycle to aluminium frames.
- Fatigue is significantly less common in carbon frames than in aluminium frames.

Disadvantages

- Carbon breaks if the maximum load is exceeded.
- Carbon is highly delicate. Interior damage may not be visible on the outside after an accident. Damage can only be detected by pulse thermography or ultrasonic excitation, for example, at a specialist retailer's.
- Carbon frames are sensitive to heat. Several hours over 65 °C can soften the frame and cause the individual layers of carbon to separate from one another. This is called delamination.
- Fractures which cut through carbon fibres cannot be repaired. A new frame needs to be acquired in such a case.
- Carbon is very difficult to recycle.

Frame size

The size of the frame must be adjusted to the rider's height.

City and trekking bicycle, folding bicycle and cargo bike

The tolerance for the frame height and its associated top tube length is somewhat greater for city bicycles due to the more upright riding position. As the handlebars and saddle can be adjusted to the rider's height, the range of recommended frame sizes can be somewhat wider.

Rider's height [cm]	Frame size [cm]	
155... 165	S	43... 48
165... 175	M	48... 53
175... 185	L	53... 58
185... 195	XL	58... 62
195... 215	XXL	62... 65

Table 12: Recommended frame size for city and trekking bicycles

Mountain bike

The frame geometries for mountain bikes differ depending on the type and area of use. The frame size is not dependent on the wheel size. The differences are already taken into account in the recommended frame sizes.

Rider's height [cm]	Frame size [cm]	Wheel size [inches]
150... 160	33... 37	26
160... 170	38... 43	26, 27.5
170... 180	43... 47	26, 27.5, 29
180... 190	47... 52	26, 27.5, 29
190... 200	51... 56	27.5, 29
200... 215	53... 60	27.5, 29

Table 13: Recommended frame size for mountain bikes

Racing bicycles and gravel bikes

The different frame heights are closer together on racing bicycles and gravel bikes. Smaller increments in the frame heights ensure precise adjustment to the rider's height.

The seat on the pedelec is largely determined by the length of the top tube:

- The shorter the top tube is, the steeper the sitting position is.
- The longer the top tube is, the more stretched-out the sitting position is.

Rider's height [cm]		Frame size [cm]
160... 175	XS	46... 48
165... 180	S	49... 51
170... 185	M	52... 54
175... 190	L	54... 56
180... 195	XL	57... 59
185... 200	XXL	58... 61

Table 14: Recommended frame size for racing bicycles and gravel bikes

Bicycle for young adults

A person grows in height rapidly during adolescence. As a result, the frame size needs to be checked every six months.

Rider's height [cm]	Frame size [cm]
140... 150	33... 35
150... 160	35... 38
160... 170	38... 41
170... 180	41... 46
180... 190	46... 53

Table 15: Recommended frame size for mountain bikes and bicycles for young adults

Child's bike

Children are growing constantly. As a result, the frame size needs to be checked every six months.

It is important that riders, especially learners, can safely put both feet on the ground. Children thus need a pedelec that is appropriate for their height. This is the only way to ensure a safe ride.

Rider's height [cm]	Wheel size [inches]
85... 110	12
90... 120	16
100... 125	18
110... 130	20
120... 145	24
135... 165	26

Table 16: Recommended wheel size for child's bicycles

3.3.2.2 Rear frame damper

A rear frame damper is primarily fitted to mountain bikes and helps to protect the pedelec and rider against impacts and vibrations caused by uneven ground. A rear frame damper deflects when a steel spring, air suspension, or both suspension types act on it.

Negative deflection (sag)

Sag is the percentage of the entire spring deflection that is compressed by the rider's body weight, including equipment (such as a backpack), their seating position and frame geometry. Sag is not caused by riding.

The rear frame damper rebounds at a controlled speed if it is optimally adjusted. The rear wheel does not bounce off rough surfaces or the ground; it stays in contact with the ground instead (blue line).

The saddle is raised slightly if the bump is compensated and gently sinks downwards when the suspension deflects as soon as the wheel touches the ground after the bump. The rear frame damper rebounds in a controlled way, so that the rider remains sitting in a horizontal position when the next bump is absorbed. The suspension motion is predictable and controlled. The rider is not thrown upwards or forwards (green line).

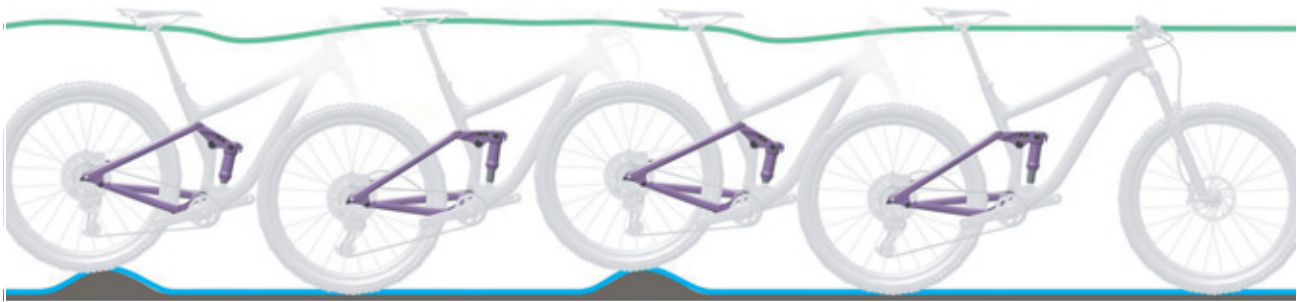

Figure 5: Optimum rear frame damper riding performance

When optimally adjusted, the rear frame damper counteracts deflection, stays higher in its

deflection range and helps the rider to maintain speed when riding on hilly parts of terrain.



Figure 6: Optimum rear frame damper ride performance on hilly terrain

When optimally adjusted, the rear frame damper deflects quickly and unhindered when the bike hits bumps and absorbs a bump. Traction is retained (blue line).

The saddle rises slightly when absorbing a bump (green line).



Figure 7: Optimum rear frame damper ride performance over bumps

SR SUNTOUR Edge LOR8 Trunnion Mount rear frame damper

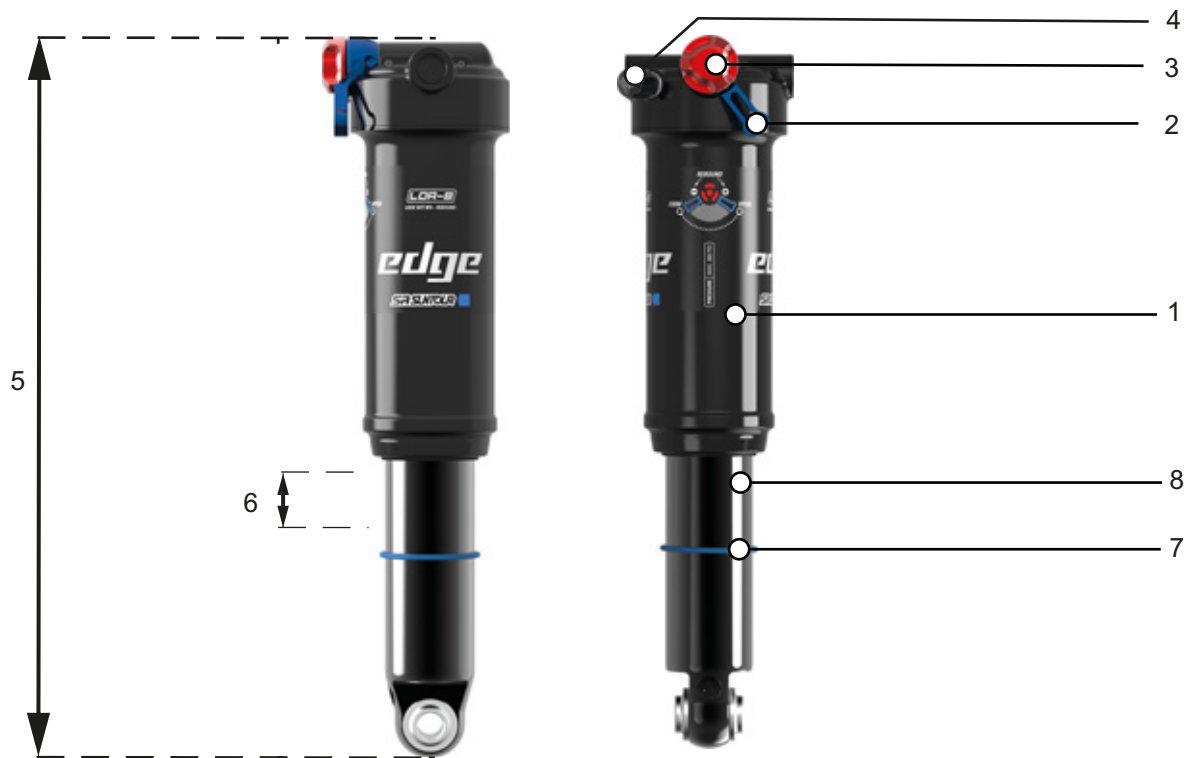

Figure 8: Example of SUNTOUR Edge LOR8 Trunnion Mount rear frame damper

- 1 Air reservoir
- 2 Compression lever
- 3 Rebound adjuster wheel
- 4 Air valve (rear frame damper)
- 5 Overall length
- 6 Sag
- 7 O-ring
- 8 Damper unit

Specifications

Suspension type	Air suspension
Damping	LOR8
Settings	<ul style="list-style-type: none"> • Rebound adjustable using the rebound adjuster wheel (low speed rebound) with 80% lockout • Compression with compression lever
Max. pressure [PSI]	300

Table 17: Specifications for SUNTOUR Edge LOR8 Trunnion Mount rear frame damper

3.3.2.3 Steering system

The steering system components are:

- Steering headset,
- Stem,
- Handlebars and
- Suspension fork.

3.3.2.4 Steering headset

The steering headset (also known as a bike headset or simply a headset) is the fork bearing system in the frame. A distinction is made between two different types:

- Conventional steering headsets for fork steerers with thread and
- Steering headsets for threadless fork steerers or what are known as headsets.

3.3.2.5 Stem

The stem connects the handlebars to the fork steerer tube. The stem is used to adjust the handlebars to body size. The stem is used to adjust the handlebar height and the gap between the handlebars and saddle (see Section 6.5.6).

Quickly adjustable stems

Quickly adjustable stems are an extension to the fork steerer. You can change the height and angle of quickly adjustable stems without any tools. Up to 3 settings can be adjusted, depending on the model:

- 1 Adjust handlebar height
- 2 Adjust twist function
- 3 Adjust stem angle.

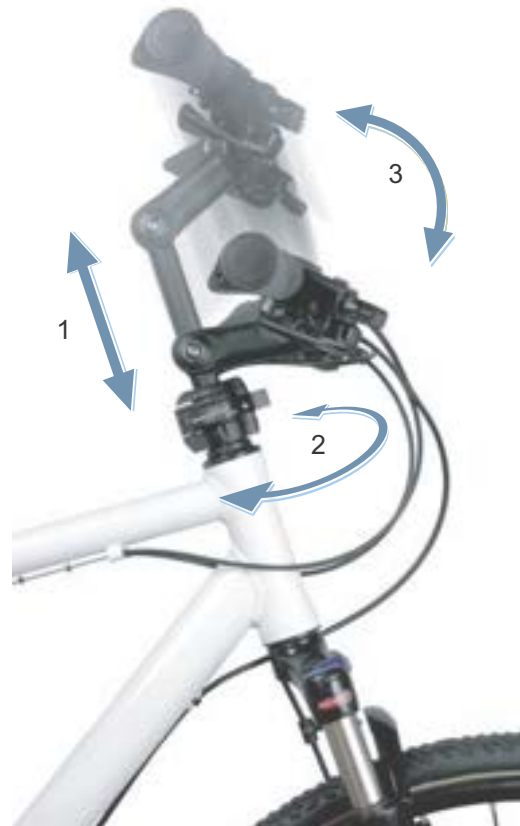

Figure 9: Example – BY.SCHULZ seat Speedlifter Twist Pro SDS

Adjusting the height and stem angle increase ride comfort as different riding positions can be adopted on longer rides. The twist function saves space when parking.

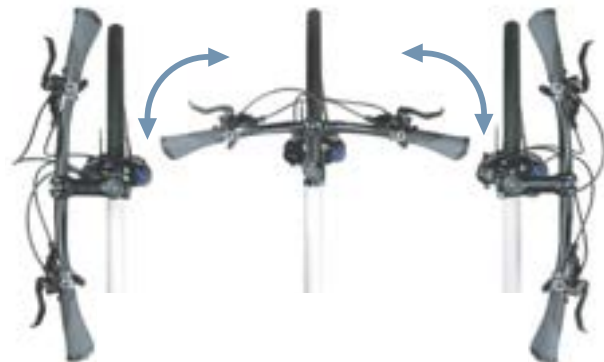

Figure 10: Twist function, using BY.SCHULZ as an example

3.3.2.6 Handlebars

The pedelec is steered using the handlebars. The handlebars are used to support the upper body and is the mount for operating and display components (see Section 3.5.1).

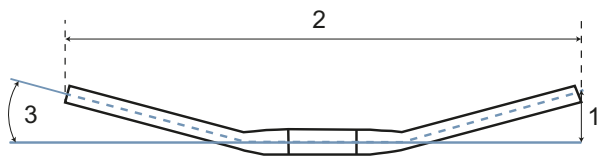

Figure 11: Handlebar dimensions

The main dimensions of handlebars are:

- 1 Rise (height)
- 2 Width
- 3 Backsweep

3.3.2.7 Suspension fork

The stem and handlebars are attached to the top end of the fork steerer. The axle is fastened to the fork ends. The wheel is fastened to the axle.

Unlike rigid forks, suspension forks improve contact with the ground and thus enhance comfort using two functions:

- Suspension and
- Damping (optional function).

The compression can be disabled in any suspension fork. A suspension fork will then behave like a rigid fork.

Suspension

A suspension fork deflects when a steel suspension, air suspension or both suspension types act on it.

The suspension in a pedelec prevents an impact, such as one caused by a stone lying in the pedelec's path, from being channelled directly into the rider's body via the fork. The impact is absorbed by the suspension system instead. This causes the suspension fork to compress.

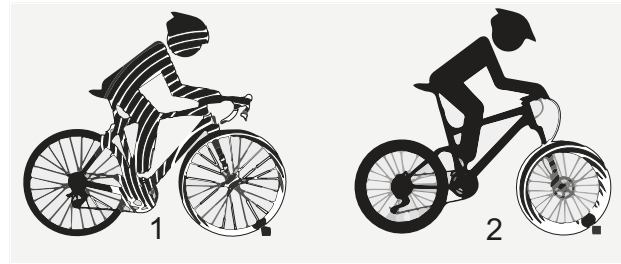

Figure 12: Without suspension (1) and with suspension (2)

Damping

After compressing, the suspension fork returns to its original position. If there is a damper, it decelerates movement, preventing the suspension system from springing back in an uncontrolled manner and stopping the fork from vibrating up and down. A distinction is made between two types of dampers:

- Rebound dampers,
- Compression dampers.

Rebound dampers and compression dampers can be optionally divided into two different sections:

- High-speed damper,
- Low-speed movements.

Suspension fork structure

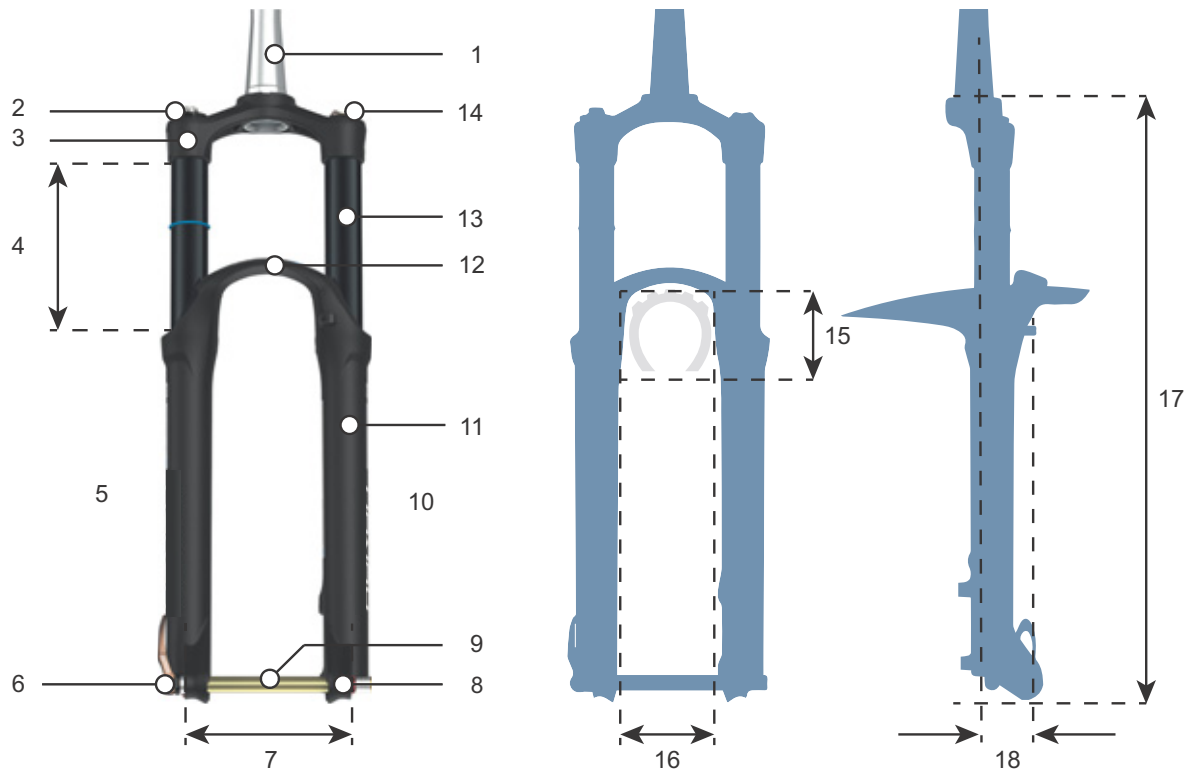

Figure 13: Suspension fork structure

- 1 Fork steerer
- 2 Sag adjuster
- 3 Fork crown
- 4 Deflection (fork)
- 5 Damper side
- 6 Quick release
- 7 Pitch
- 8 Fork end (fork)
- 9 Quick release axle
- 10 Air suspension side
- 11 Stanchion
- 12 Fork bridge
- 13 Stanchion
- 14 Lock

Tyre clearance

- 15 Tyre height
- 16 Tyre passage width

Side view

- 17 Installation height
- 18 Offset

Fork assembly groups

A suspension fork can feature up to three different assembly groups:

- Compression damper (blue)
- Rebound damper (red)
- Air suspension or steel spring (orange)

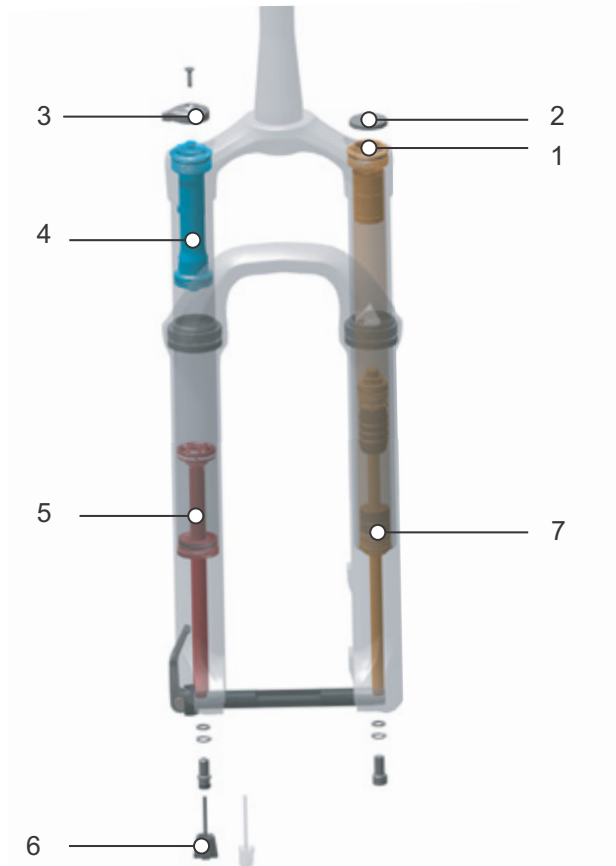

Figure 14: Internal structure of an air suspension fork

- 1 Air valve (fork)
- 2 Air valve cap
- 3 Sag setting wheel
- 4 Compression dampers
- 5 Rebound damper
- 6 Rebound screw
- 7 Air suspension

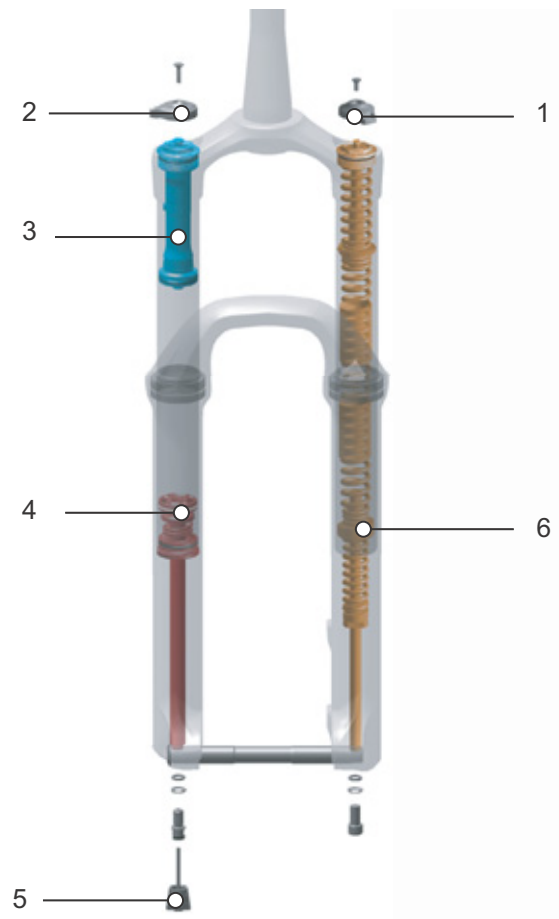

Figure 15: Internal structure of a steel spring fork

- 1 Deflection adjustment ring
- 2 Sag setting wheel
- 3 Compression dampers
- 4 Negative deflection (sag)
- 5 Rebound adjuster
- 6 Steel spring

Cartridges

Dampers may be housed in closed structural elements, known as cartridges. These cartridges are fitted into the fork. Different cartridges can be fitted into forks. This has no effect on the fork's total bearing capacity.

Negative deflection (sag)

The negative deflection (sag) is the percentage of entire deflection that is compressed by the rider's body weight, including equipment (such as a backpack), the seating position and frame geometry. Sag occurs whether you are actually riding or not.

The pedelec rebounds at a controlled speed if it is optimally adjusted. The wheel stays in contact with the ground when passing over bumps (blue line). The fork head, handlebars and body follow terrain (green line) when riding over bumps. The suspension motion is predictable and controlled.

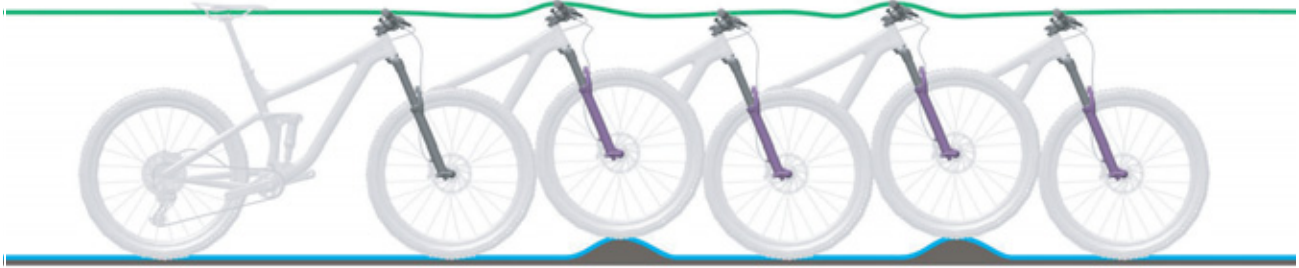

Figure 16: Optimum fork ride performance

When optimally adjusted, the fork counteracts deflection on hilly terrain and stays higher in its deflection range.

This allows the rider to maintain the same speed more easily on hilly terrain.



Figure 17: Optimum fork ride performance on hilly terrain

When optimally adjusted, the fork deflects quickly and unhindered when the bike hits bumps and absorbs a bump. Traction is retained (blue line).

The fork responds quickly to the bump. The headset and handlebars rise slightly when absorbing a bump (green line).



Figure 18: Optimum fork ride performance over bumps

Rebound dampers

Rebound dampers damp rebound movements, i.e. rebound stress loads. Rebound damping determines the speed at which the suspension rebounds after being exposed to load. Rebound damping controls the suspension fork extension and rebound speed, which, in turn, has an impact on traction and control. Rebound damping can be adjusted to body weight, spring stiffness, deflection, the terrain and the pedelec rider's preferences. If the air pressure or spring stiffness

increases, the extension and rebound speeds also increase. Rebound damping needs to be increased to achieve an optimal setting if the air pressure or spring stiffness is increased. The damper rebounds at a controlled speed if the fork is optimally adjusted. The wheel stays in contact with the ground when passing over bumps (blue line). The fork head, handlebars and body follow terrain (green line) when riding over bumps. The suspension motion is predictable and controlled.



Figure 19: Optimum fork ride performance

Compression dampers

Compression dampers damp deflection movements, i.e. compression loads. The compression damper allows the rider to make quick adjustments to the suspension behaviour of the fork to adapt to changes in terrain. It is intended for adjustments made during the ride. The compression damper controls the compression lifting speed or the extent to which the fork deflects during slow impacts. The compression damper affects the absorption of

bumps when weight shifts or when braking and during transitions, cornering, and uniform impacts caused by bumps. When optimally adjusted, the fork counteracts deflection on hilly terrain, stays higher in its deflection range and helps to maintain speed when riding on hilly terrain. The fork deflects quickly and unhindered and absorbs the bump when the bike hits a bump. Traction is retained (blue line).



Figure 20: Optimum ride performance on hilly terrain

High-speed damper

A high speed is generated in the suspension fork, e.g. on a mogul slope or during landing after a jump.

The settings on the high-speed damper control the suspension behaviour of the fork during

- stronger impacts
- small, rapid impacts (e.g. stairs)
- landings after quick, successive jumps.

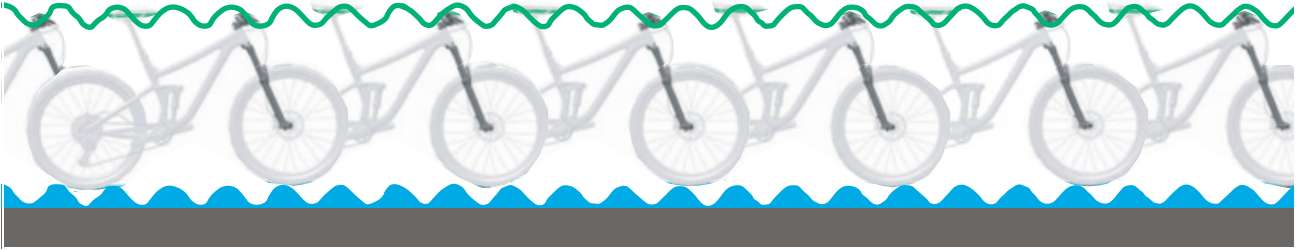

Figure 21: High-speed movements

Low-speed movements

Low-speed movement in the suspension fork is caused, for example, by riding over bumps.

The settings of the low-speed damper control the suspension behaviour of the fork

- during staggered jumps
- during shifts in the rider's weight
- when force is applied slowly.



Figure 22: Low-speed movements

SR SUNTOUR cartridge function chart

	Lockout remote control	Lockout Fork head	Compression damping setting			Rebound damping setting			Blow-off feature	PCS
			High-speed	Low-speed	Fixed	High-speed	Low-speed	Fixed		
R2C2-PCS			x	x		x	x		x	x
RC2-PCS			x	x			x		x	x
RC-PCS				x			x		x	x
RLRC-PCS	x			x			x		x	x
LORC-PCS		x		x			x		x	x
R2C2			x	x		x	x		x	
RC2			x	x			x		x	
RC				x			x		x	
RLRC	x			x			x		x	
LORC		x		x			x		x	
RLR	x				x		x		x	
LOR		x			x		x		x	
RL	x				x			x	x	
LO		x			x			x	x	
NLO		x						x		
HLO		x								

SR SUNTOUR LORC-PCS



Figure 23: LORC-PCS operating elements

The SR Suntour LORC-PCS cartridge features a PCS damper platform with

- a low-speed compression damper
- a low-speed rebound damper

Floating pistons within the PCS cartridge provide consistent damping on all driving surfaces through minimal cavitation (formation and dissolution of bubbles by mixing air and oil).

Before riding, the rebound adjuster (1) is used to adjust the system to the surface concerned.

The suspension system can be adjusted to the current surface during rides using the low-speed compression adjustment wheel (2). The compression adjuster can also be used to open and close the damping.

If the pressure in the fork is too high, the blow-off feature releases air by opening a valve. This prevents any damage due to overpressure.

		Function available
	Lockout remote control	...
	Fork head lockout	x
Compression damping	High-speed	...
	Low-speed	x
	Fixed	...
Rebound damping	High-speed	...
	Low-speed	x
	Fixed	...
	Blow-off feature	x
	PCS	x

Table 18: An overview of SR SUNTOUR LORC-PCS functions

3.3.3 Wheel

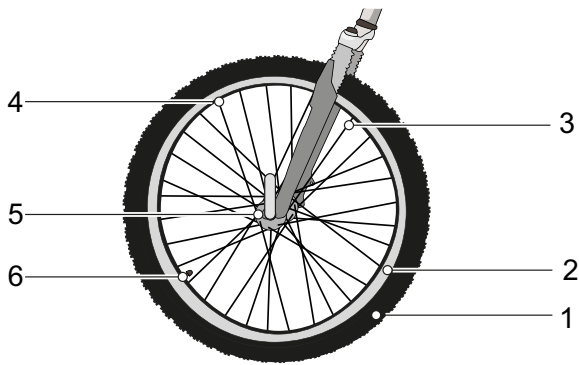

Figure 24: Visible wheel components

1	Tyres
2	Rim
3	Spoke
4	Spoke nipples
5	Hub
6	Valve

The wheel comprises a tyre, an inner tube with a valve and the wheel itself.

3.3.3.1 Tyres

The tyre forms the outer section of the wheel. The tyre is pulled onto the rim. Tyres differ in design, profile and width, depending on their intended use.



Figure 25: Example: Information on tyres

Tyre size

The tyre size pressure range is indicated on the side of the tyre.

Tyre pressure

The permitted pressure range is indicated on the side of the tyre. It is indicated in psi or bars. The tyre is only able to support the pedelec if there is adequate tyre pressure. The tyre pressure must be adjusted to the body weight and then checked on a regular basis.

Tyre design types

There are five different tyre design types:

- Tube-type tyres,
- Tubeless tyres (also tubeless ready)
- Tubular or single tube tyres
- Solid tyres
- Mixed types.

3.3.3.2 Tube-type tyre

A distinction is made between different kinds of tube-type tyre:

- Clinchers with steel wire reinforcement in bead core
- Folding tyres with aramid fibre reinforcement in bead core
- Beaded edge tyres without reinforcement in the bead core but with pronounced beads that hook under the rim edge and overlap in the rim well.



Figure 26: Structure of tube-type tyre

1	Rim
2	Carcass
3	Puncture protection belt (optional)
4	Tread with profile
5	Bead core

Carcass

The carcass is the tyre's supporting structure. There are usually three carcass plies beneath the tread. The carcass comprises a webbing with threads, usually made of polyamide (nylon). The webbing is coated with rubber on both sides and cut at an angle of 45°. The carcass gives the tyre stability thanks to this cut at an angle to the direction of travel. The carcass plies are woven with different densities, depending on the quality of the tyres. The density of the carcass fabric is indicated by the number of threads per inch, in EPI (*ends per inch*) or TPI (*threads per inch*). There are tyres with between 20 and 127 EPI carcasses.

If the EPI value is higher, the diameter of the threads used is lower. Carcass plies with a higher EPI value have threads with a smaller diameter. The higher the EPI value:

- the less rubber is needed to encase the threads,
- the lighter the tyres are
- the more flexible the tyres are and they consequently have less rolling resistance.
- The webbing is denser, so that there is greater resistance to penetration of foreign bodies. This increases puncture resistance.

In carcasses with 127 EPI, each individual thread is just 0.2 mm thick and, consequently, more susceptible to damage. This means that a 127 EPI tyre offers low puncture protection. 67 EPI offers the optimum compromise between weight and robustness.

Besides the webbing, the tyre's rubber compound is also important. The rubber compound comprises numerous parts:

40 ... 60%	Natural and synthetic rubber
15 ... 30%	Fillers, e.g. carbon black, silicic acid or silica gel
20 ... 35%	<ul style="list-style-type: none"> • Anti-ageing agent • Vulcanisation agent, e.g. sulphur • Vulcanisation accelerator, e.g. zinc oxide • Pigments and dyes

Table 19: Rubber compound in carcasses

Tread with profile

A rubber tread is attached to the exterior of the carcass.

The tread has little influence on riding characteristics on a smooth road. The grip between the road and tyre is mainly provided by the rolling friction between the rubber and the road surface.

Slicks and road tyres

Unlike cars, a pedelec will not aquaplane. The tread contact is small and the contact pressure high. Thanks to the small contact surface on narrow and treadless tyres, the tyre interlocks with the road surface finish. Theoretically, the tyre will not aquaplane until speeds of 200 km/h are reached.

On a clean road, whether dry or wet, slick tyres will grip more effectively than treaded tyres because the contact surface is larger. The rolling resistance of slick tyres is also lower.

Off-road tyres

The tread is highly important on terrain. In this case, the tread creates an interlock with the ground, thus enabling the driving, braking and steering forces to be transmitted. The MTB tread can also help improve control on dirty roads or farm tracks.

Tread blocks on MTB tyres deform as they meet the contact surface. The energy used for this is partly converted into heat. Another part is stored and converted into the tread block's sliding movement when it leaves the contact surface, which contributes to the tyre's wear.

If a tyre with a deep tread is used on asphalt, this may make an unpleasant noise. If a pedelec with an MTB tyre is mainly ridden on the road, it is thus best to change the tyre for a pair of tyres with as little tread as possible to reduce wear and save energy. In such a case, the specialist dealer needs to replace the tyre with a new one with a shallow tread.

Bead core

Tyre carcasses are wrapped around bead cores. Wrapping the carcass around both sides creates three carcass plies.

To ensure that tyres do not slip when inflated on the rim and have an effective grip, the bead cores are stabilised in two different ways:

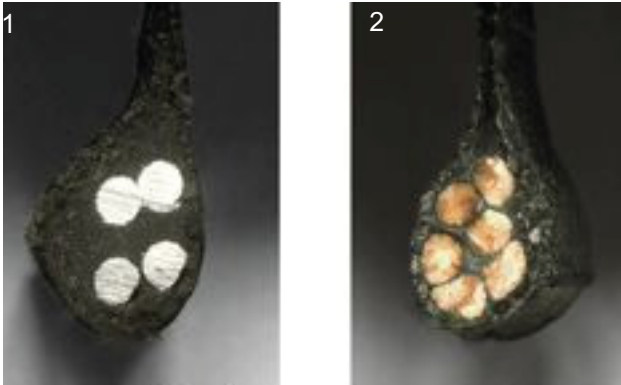

Figure 27: Steel bead core (1) and Kevlar bead core (2)

- with a steel wire. These tyres are called clinchers.
- with aramid fibres (Kevlar®). These tyres are called folding tyres. Folding tyres are about 50-90 g lighter than clinchers. It can also be folded into a smaller pack size.

Puncture protection belt (optional)

There may be a puncture protection belt between the carcass and the tread.



Figure 28: Effect of puncture protection belt

Each tyre manufacturer has its own puncture protection classes which are not on par with one another.

3.3.3.3 Rim

The rim is the metal profile on a wheel which holds the tyre, tube and rim band together. The rim is joined to the hub with spokes.

In rim brakes, the outer surface of the rim is used to brake.

3.3.3.4 Valve

Each tube-type tyre has a valve. Air is pumped into the tyre via the valve. There is a valve cap on each valve.

The screw-on valve cap keeps out dust and dirt.

The pedelec has either a:

- Dunlop valve
- Presta valve
- Schrader valve

Dunlop valve

The Dunlop valve, also known as a conventional valve, is the most widely used valve. The valve insert can be replaced easily and air can be let out very quickly.

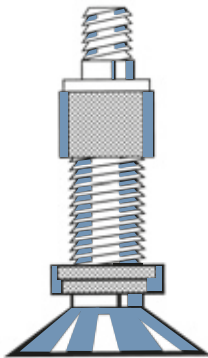

Figure 29: Dunlop valve

Presta valve

The Presta valve, also known as the Sclaverand valve or the French valve, is the narrowest variant of all valves. The Presta valve requires a smaller hole in the rim, which is why it is especially suitable for the narrow rims on racing bikes. It is about 4 to 5 g lighter than a Dunlop or Schrader valve.

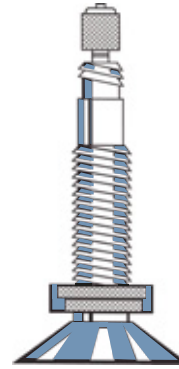

Figure 30: Presta valve

Schrader valve

The Schrader valve can be pumped at filling stations. Older, simple bicycle air pumps are unsuitable for Schrader valves.

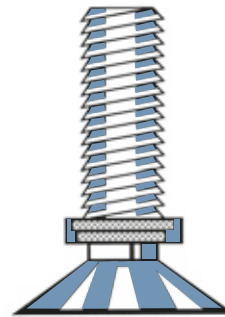

Figure 31: Schrader valve

3.3.3.5 Spoke

A spoke is a rod that connects the hub to the rim. The bent end of the spoke which is hooked into the hub is called the spoke head. A thread between 10 mm and 15 mm is attached to the other end of the spoke.

3.3.3.6 Spoke nipples

Spoke nipples are screw elements with an internal thread which fits onto the spoke thread. Fitted spokes are tensioned by tightening the spoke nipples. This straightens the wheel uniformly.

3.3.3.7 Hub

The hub is located in the centre of the wheel. The hub is connected to the rim and tyre with the spokes. An axle runs through the hub, connecting the hub with the fork at the front and with the frame at the rear.

The hub's main task is to transfer the pedelec's force of weight to the tyres. Special hubs on the rear wheel perform additional functions. There is a distinction between five types of hub:

- Hubs without additional features
- Brake hub (see back-pedal brake)
- Gear hub, also known as a hub gear
- Generator hub (for bicycles only)
- Motor hubs (for front- and rear-driven pedelecs only).

Hub without additional features

The front wheel hubs on pedelecs with central or rear motors are normally hubs without additional features.

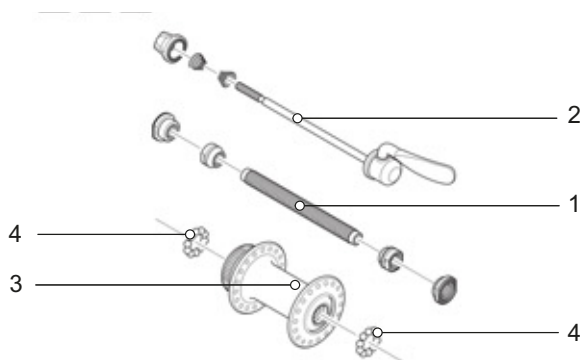

Figure 32: Example of front wheel hub: SHIMANO

- | | |
|---|---------------|
| 1 | Hub axle |
| 2 | Quick release |
| 3 | Hub body |
| 4 | Ball bearings |

3.3.4 Saddle

The purpose of the saddle is to absorb body weight, provide support and enable different riding positions. The shape of the saddle thus depends on the intended use of the pedelec and the rider's physique and posture.

When riding, the rider's body weight is distributed between the pedals, the saddle and the handlebars. When the rider is in an upright position, the relatively small saddle area bears about 75% of their body weight.

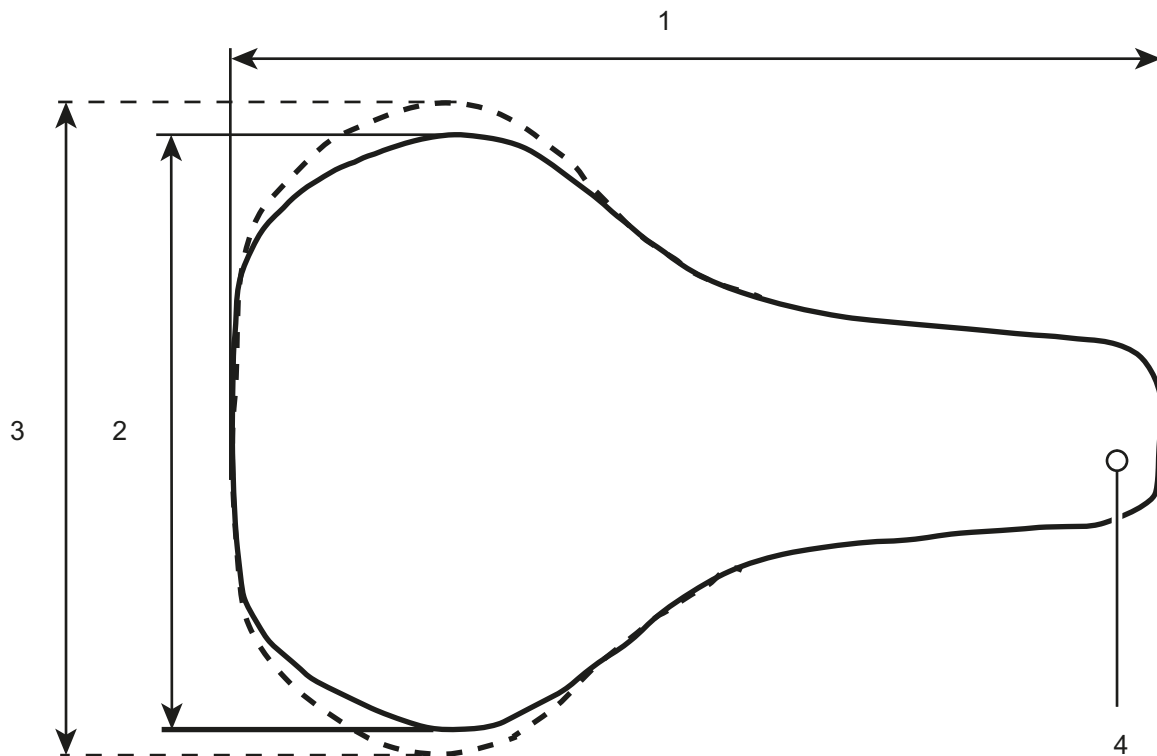

Figure 33: Saddle dimensions

- 1 Saddle length
- 2 Saddle width (narrow version)
- 3 Saddle width (wide version)
- 4 Saddle nose

The seat area is one of the most sensitive regions of the body. The saddle should allow the rider sit free of pain and fatigue. The saddle shape must suit each individual's anatomy. Solutions for sitting discomfort are listed in Section 9.1.

Saddles are provided in different sizes. The width of the pelvis and the gap between the sitting bones is crucial when selecting a saddle. Different saddle variants thus differ in their width.

You will find two methods to calculate the minimum saddle width in Sections 6.5.4.3 and 6.5.4.4.

3.3.4.1 Ladies' saddle

The distance between the ischial tuberosities and the pubic symphysis is on average a quarter less in women than in men. This is why painful pressure points can occur on men's saddles through the saddle nose since saddles that are too narrow or too soft press on the genitals or coccyx.



Figure 34: Female pelvis on saddles

For anatomical reasons, the pubic symphysis (front cartilage connection between the two halves of the pelvis) is, on average, a quarter lower than in the male pelvis. The angle between the pubic bones is wider.

The pelvis is more mobile in women than it is in men. Consequently, the pelvis often tilts forward more on the saddle. This causes high pressure in the genital area.

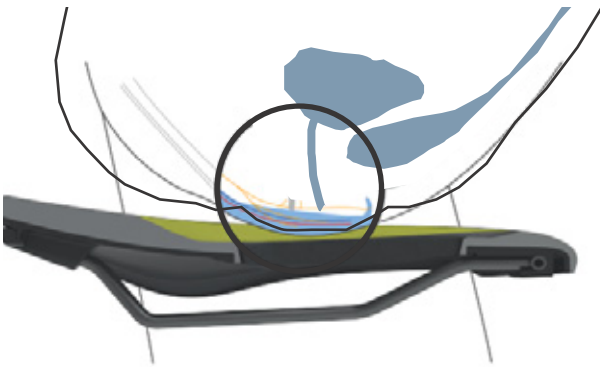

Figure 35: Pressure points on a saddle, female anatomy

3.3.4.2 Men's saddle

In contrast to the female anatomy, men's pubic bones are at a much steeper angle to one another. The pubic symphysis is much higher.



Figure 36: Male pelvis on saddles

The male pelvis is less flexible than women's. Men sit more upright on the saddle and put greater strain on the sitting bones. This means that the transition area between the saddle rear and nose can be kept narrow (Y-shape). This gives more space to pedal.

Numbness when pedalling is often caused by high pressure in the sensitive perineal area. If the saddle is adjusted incorrectly, too narrow or too hard, the nose of the saddle presses directly onto the genitals. Blood circulation deteriorates. The genitals on the outside are seldom the cause of discomfort since they can move out of the way and are not compressed by bone structures.

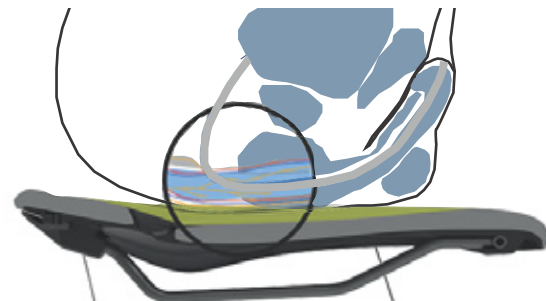

Figure 37: Pressure points on a saddle, male anatomy

3.3.5 Seat post

Seat posts are not designed to fasten the saddle but also to adjust exactly to the optimum sitting position. The seat post can:

- adjust the seat height in the seat tube
- adjust the saddle horizontally with a clamping mechanism and
- adjust the saddle angle by swivelling the entire saddle clamping mechanism.

Retractable seat posts feature a remote control on the handlebars, which can be used to lower the seat post at traffic lights, for example, and then raise it again.

3.3.5.1 Patent seat post



Figure 38: Example of ergotec patent seat post with either one or two seat clamp screws

Patent seat posts have a rigid link between the saddle and the post. Patent seat posts which are angled more markedly towards the rear are offset seat posts. Offset seat posts provide a greater distance between the saddle and the handlebars.

In patent saddle posts, the saddle is attached to the head with one or two seat clamp screws. It is recommended to lubricate the thread in these screws to ensure sufficient tension when tightening the screw.

Patent saddle posts are fastened into the seat tube with either a quick release or a screwable clamp.

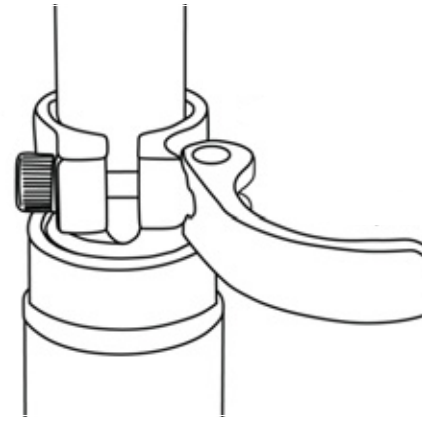

Figure 39: Example of a quick release

3.3.5.2 Suspension seat post

Suspension seat posts can reduce shock after one-time hard impacts, thus improving ride comfort significantly. However, suspension seat posts are not able to compensate for bumps in the road.

If the seat post is the only suspension element, the entire pedelec is a non-suspended mass. This has an unfavourable effect on loaded touring bikes or pedelecs with child trailers.

Suspension seat posts feature small, heavy-duty slide bearings, guides and articulated joints. If they are not lubricated on a regular basis, the sensitive response behaviour diminishes considerably, causing excessive wear.

The preload in non-damped suspension seat posts must be adjusted in such a way that the suspension seat post does not deflect with just body weight. This prevents the suspension seat post from deflecting and bobbing intermittently at higher pedalling frequencies or if the rider pedals irregularly.

The spring stiffness can be set lower with damped suspension seat posts, thus making use of the negative deflection.

LIMOTEC, A1

The LIMOTEC A1 is a continuously height-adjustable seat post, which can be lowered using a remote control on the handlebars. The remote control can be used to adjust the saddle height during a ride, e.g. when stopped at traffic lights. Both hands remain on the handlebars during adjustment.

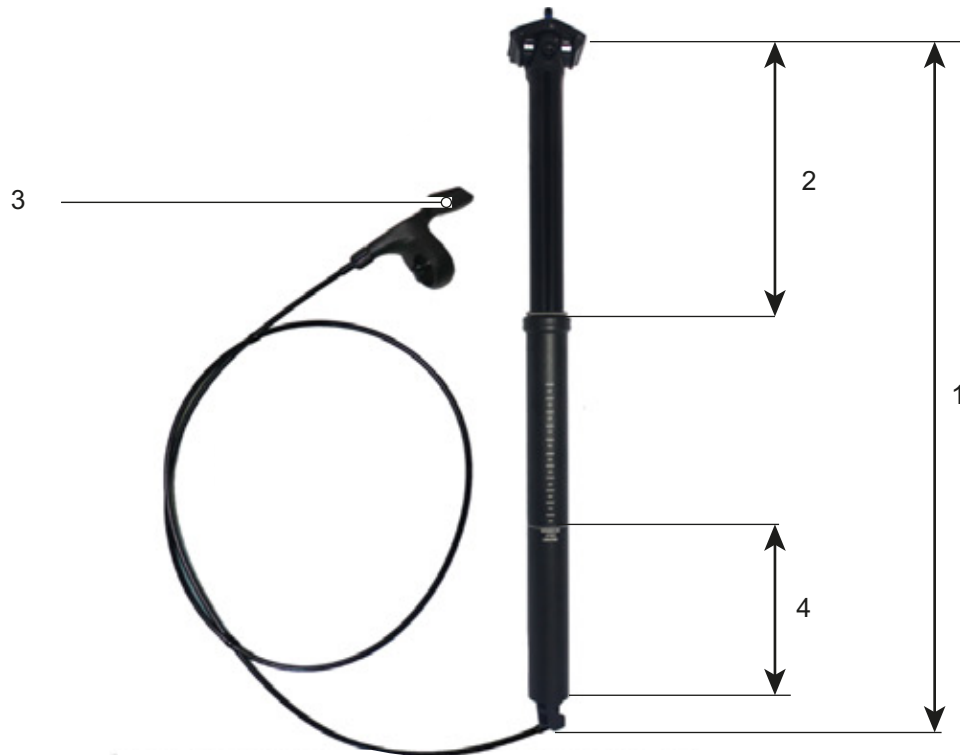

Figure 40: Structure and dimensions of the LIMOTEC A1 seat post

- 1 Seat post length
- 2 Stroke travel
- 3 Seat post remote control
- 4 Minimum insertion depth

Stroke travel

The stroke travel is the maximum height that the seat post can extend.

LIMOTEC, Alpha 3

The LIMOTEC Alpha 3 suspension seat post is a continuously height-adjustable seat post, which can be lowered using a remote control on the handlebars.

The remote control can be used to adjust the saddle height during a ride, e.g. when stopped at traffic lights. Both hands remain on the handlebars during adjustment.

The suspension in the seat post ensures sitting comfort when riding over rough terrain (e.g. in woodland or on farm tracks).

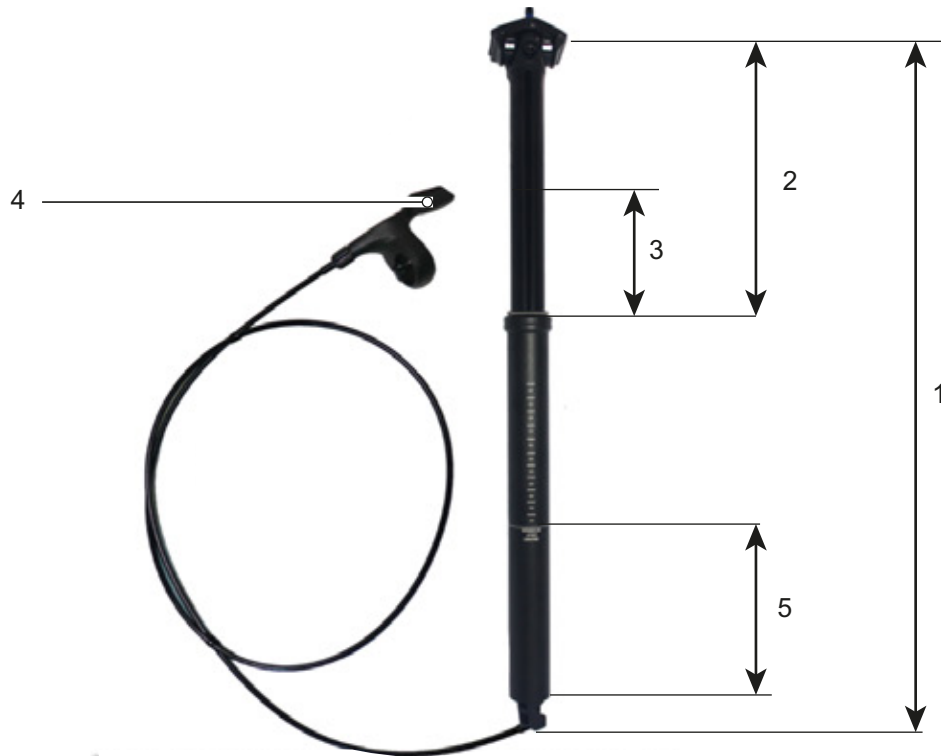

Figure 41: Structure and dimensions of the LIMOTEC Alpha 3 seat post

- 1 Seat post length
- 2 Stroke travel
- 3 Deflection
- 4 Seat post remote control
- 5 Minimum insertion depth

Stroke travel

The stroke travel is the maximum height that the seat post can extend.

Deflection

Deflection is the distance that the suspension seat post can deflect.

3.3.6 Brake

A pedelec's brake system is primarily operated using the brake lever on the handlebars.

- If the left brake lever is pulled, the brake on the front wheel is applied.
- If the right brake lever is pulled, the brake on the rear wheel is applied.

The brakes are used to regulate speed and make an emergency stop. Applying the brakes will bring the pedelec to a safe, rapid halt in an emergency.

The brake is applied using the brake lever either

- with the brake lever and shift cable (mechanical brake) or
- with the brake lever and hydraulic brake cable (hydraulic brake).

3.3.6.1 Mechanical brake

The brake lever is connected to the brake via a wire inside the shift cable (also known as a Bowden cable).



Figure 42: Bowden cable structure

3.3.6.2 Hydraulic brake

The brake fluid is in a closed hose system. If the brake lever is pulled, the brake fluid transfers pressure to the brake on the wheel.

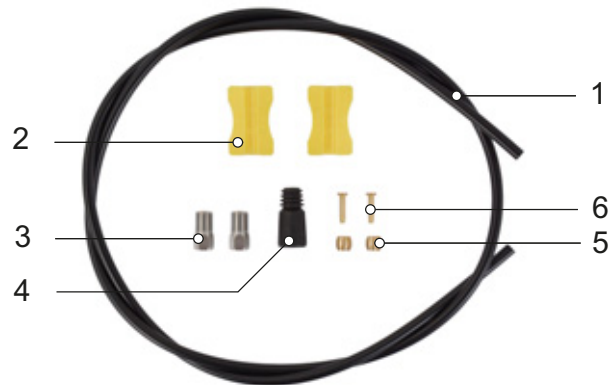

Figure 43: Components in a brake cable

- | | |
|---|-------------|
| 1 | Brake cable |
| 2 | Cable clip |
| 3 | Union nut |
| 4 | Cover cap |
| 5 | Knob |
| 6 | Insert pin |

3.3.6.3 Disc brake

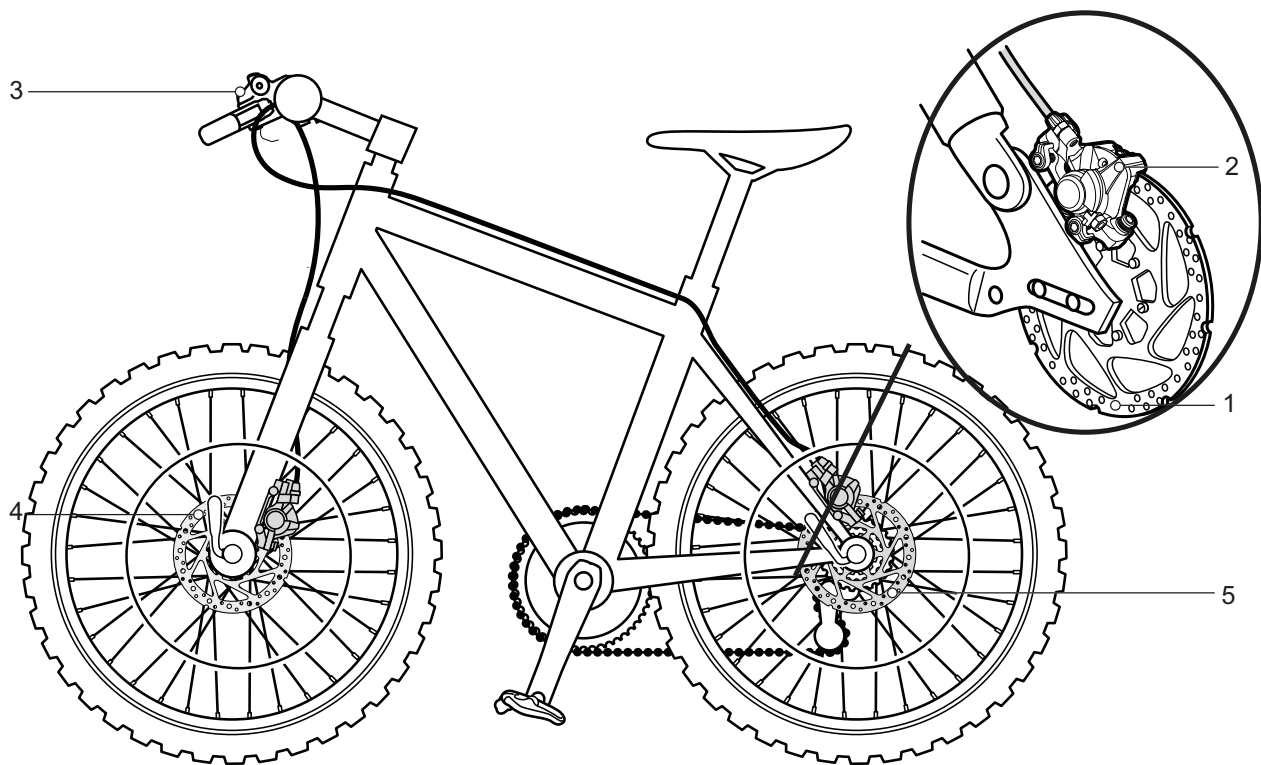

Figure 44: Brake system with disc brake – example

- 1 Brake disc
- 2 Brake calliper with brake linings
- 3 Handlebars with brake lever
- 4 Front wheel Brake disc
- 5 Rear wheel brake disc

On a pedelec with a disc brake, the brake disc is permanently screwed to the hub.

You increase brake pressure by pulling the brake lever. The brake fluid is used to transfer pressure through the brake cables to the cylinders in the brake calliper.

The braking force is boosted by a speed reduction and applied to the brake linings. These apply the brake disc mechanically. If the brake lever is pushed, the brake linings are pressed against the brake disc and the wheel movement is decelerated until it comes to a stop.

3.3.7 Mechanical drive system

The pedelec is driven by muscle power, just like a bicycle.

The force which is applied by pedalling in the direction of travel drives the front chain wheel. The chain or belt transmits the force onto the rear chain wheel and then onto the rear wheel.

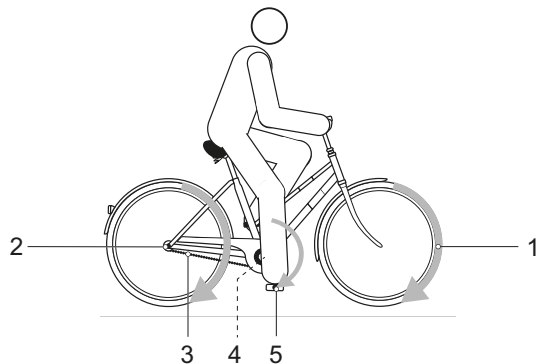

Figure 45: Diagram of mechanical drive system

- | | |
|---|----------------------------------|
| 1 | Direction of travel |
| 2 | Chain or belt |
| 3 | Rear chainring or belt sprocket |
| 4 | Front chainring or belt sprocket |
| 5 | Pedal |

The pedelec is equipped with either a chain or belt drive.

3.3.7.1 Chain drive layout



Figure 46: Chain drive with derailleur gears

- | | |
|---|-----------------|
| 1 | Rear derailleur |
| 2 | Chain |

The chain drive is compatible with a

- Back-pedal brake,
- Hub gear or
- Derailleur gears.

3.3.7.2 Belt drive layout



Figure 47: Belt drive

- | | |
|---|---------------------|
| 1 | Front belt sprocket |
| 2 | Rear belt sprocket |
| 3 | Belt |

A belt drive is compatible with

- Back-pedal brake and
- Hub gear.

A belt drive is not compatible with derailleur gears.

3.3.8 Electric drive system

The pedelec has an electric drive system in addition to a mechanical one.

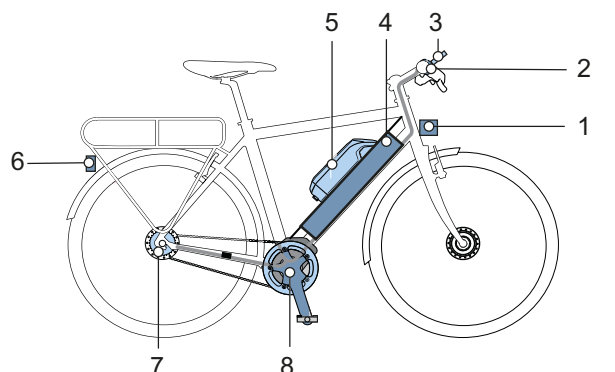

Figure 48: Diagram of an electric drive system with electric components

- | | |
|---|--|
| 1 | Front lamp |
| 2 | On-board computer |
| 3 | Display (optional) |
| 4 | PowerTube battery or |
| 5 | PowerPack battery |
| 6 | Rear light |
| 7 | Electric gear shift (optional) |
| 8 | Motor |
| 9 | A charger which is designed for the battery (not shown). |

3.3.8.1 Motor

As soon as the muscle power required for pedalling passes a certain level, the motor is activated gently and assists the pedalling motion. The motor power always depends on the power used to pedal: Motor assistance is lower when little muscle power is used than when muscle power is used. This happens regardless of the level of assistance.

The motor switches off automatically as soon as the rider no longer pedals, the temperature is outside the permitted range, there is an overload or the shut-off speed of 45 km/h has been reached.

A push assist system can be activated. The speed depends on the selected gear. The motor continues to drive the pedelec as long as the rider presses the push assist button on the handlebars. The speed can be a maximum of 6 km/h in this case. The electric drive system stops when the

push assist button is released. The pedelec does not have a separate emergency shut-off button. In the event of an emergency, the motor can be stopped by removing the on-board computer. The mechanical brakes are used as an emergency stop system and bring the bicycle to a halt quickly and safely in the event of an emergency.

3.3.8.2 Charger

Each pedelec is supplied with a charger. The following BOSCH charger may be used:

- the 4 A Charger BPC3400.

Observe the operating instructions in the Section 11.4 Documents.

3.3.8.3 Lighting

Lighting always includes

- the front lamp (also known as headlight or front light)
- The rear light (also known as rear lamp)

The headlight and the rear light are also on whenever the riding light is activated.

3.3.8.4 Rechargeable battery

BOSCH batteries are lithium ion batteries which are developed and manufactured to the latest technical standards. Each battery cell is protected by a steel cup and encased in a plastic battery housing. Applicable safety regulations are met.

- The battery has an interior electronic protection circuit, which is specifically designed for the charger and the pedelec.
- The battery temperature is monitored at all times.
- The battery is protected against deep discharge, overcharging, overheating and short circuits by Electronic Cell Protection (ECP).

In the event of a hazard, a protective circuit switches the battery off automatically. In the event of a hazard, a protective circuit switches the battery off automatically.

The battery has a high energy content when charged. The code of practice for their safe handling is found in Section 2 Safety and Section 6.9 Rechargeable battery in the operating instructions. If the electric drive system is not used for 10 minutes and no button has been pressed on the on-board computer or the control panel, the electric drive system and the battery are automatically switched off to save energy.

The type and duration of operating conditions have a significant effect on the battery life. Just like any other lithium-ion battery, the battery will age naturally if it is not being used. The battery's service life can be extended if the battery is well maintained and stored at the correct temperature. The charging capacity will decrease with age, even if the battery is maintained properly. If the operating time is severely shortened after charging, this is a sign that battery has reached the end of its useful life.

Battery performance is reduced when the temperature drops since this increases electrical resistance. You should expect the range to be less than normal at low temperatures in winter. We recommend using thermal protection sleeves when riding longer distances at low temperatures.

Each battery has its own lock.

The following battery can be built into the pedelec:



Figure 49: Overview of battery variants

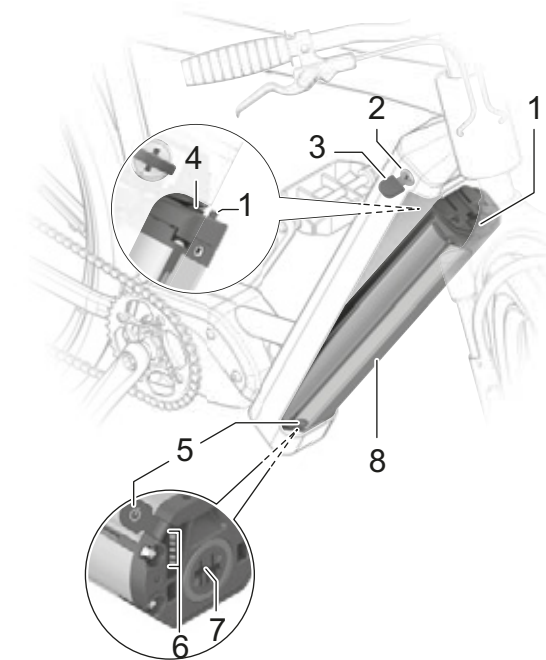

Figure 50: Details on PowerTube

- | | |
|---|-----------------------------------|
| 1 | Securing hook |
| 2 | Battery lock |
| 3 | Battery key |
| 4 | Retainer guard |
| 5 | On-Off button (battery) |
| 6 | Battery level indicator (battery) |
| 7 | Socket for charger plug |
| 8 | Battery housing |

3.3.9 On-board computer

The on-board computer on the handlebars is used as a control panel. It controls the system and all indicators on the display screen using six buttons.



Figure 51: BOSCH LED Remote on-board computer

The eBike Flow app can be accessed via Bluetooth®.

The control panel has an internal lithium ion battery. The pedelec battery powers the control panel. If a sufficiently charged battery is inserted into the pedelec and the drive system switched on, the internal battery is charged.

3.3.10 Display

The display shows the main drive system functions and the ride data.



Figure 52: BOSCH Intuvia 100 display

The display switches off automatically if it is removed from its mount.

The display is powered by a CR2450 button cell.

3.4 Description of controls and screens

3.4.1 Handlebars

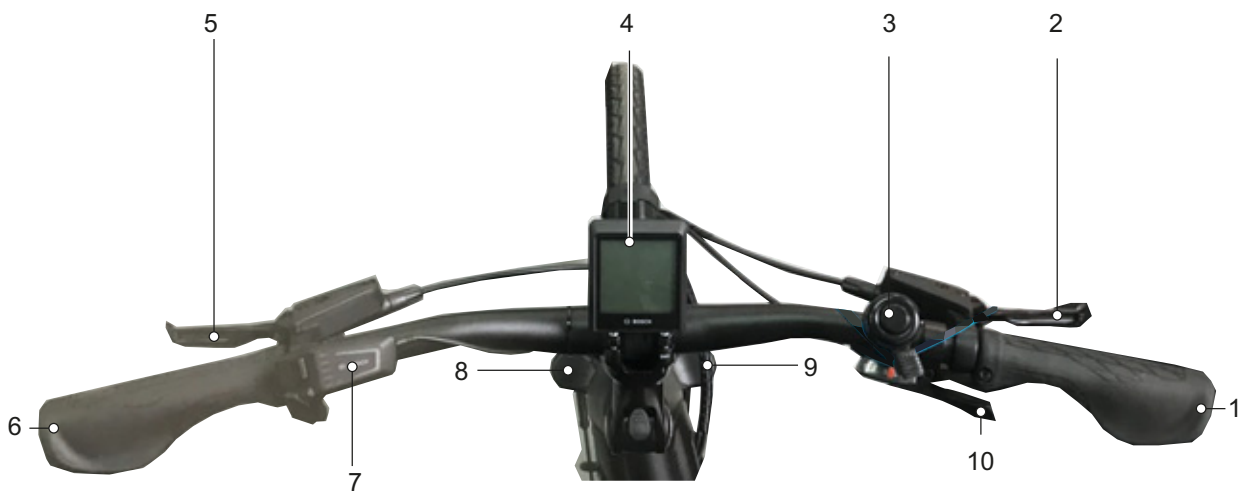

Figure 53: Detailed view of handlebars with BOSCH Kiox300, example

- 1 Handle
- 2 Rear wheel hand brake (behind handlebars)
- 3 Bell
- 4 BOSCH display, Intuvia 100
- 5 Front wheel hand brake (behind handlebars)
- 6 Handle
- 7 BOSCH LED Remote on-board computer
- 8 Air valve flap
- 9 Sag setting wheel
- 10 Shifter

3.4.2 BOSCH LED Remote on-board computer

The on-board computer on the handlebars is used as a control panel. It controls the system and all indicators on the display screen using six buttons.

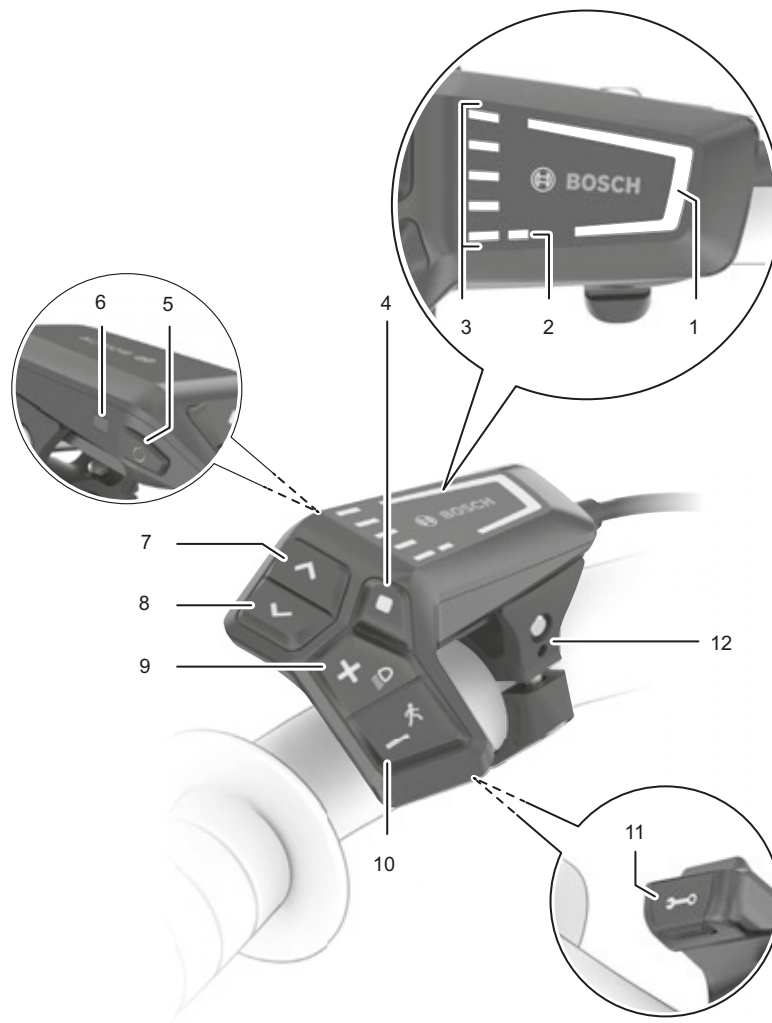

Figure 54: Overview of BOSCH LED Remote on-board computer

	Symbol	Designation
1		Selected level of assistance indicator
2		ABS indicator (optional)
3		Battery level indicator (on-board computer)
4	◆	Select button
5	⏻	On-Off button (on-board computer)
6		Ambient light sensor

Table 20: Overview for on-board computer

	Symbol	Designation
7	>	Increase brightness button/ forward button
8	<	Decrease brightness button/ back button
9	+	Plus button/ light button
10	-	Minus button/ push assist button
11		Diagnosis connection (for maintenance purposes only)
12		Mount

Table 20: Overview for on-board computer

1. Selected level of assistance indicator

The higher the selected level of assistance, the more the drive system assists with pedalling.

eMTB mode is available for Performance Line CX drives. In eMTB mode, the assistance factor and the torque are dynamically adjusted depending on the pedalling force applied to the pedals.

Level of assistance	Colour	Use
OFF	No	When the drive system is switched on, the motor assistance is switched off. The pedelec can be used like a normal bicycle by simply pedalling.
ECO	Green	Limited assistance with maximum efficiency for maximum range
TOUR	blue	Constant assistance, for long-range tours
eMTB/SPORT	Purple	Powerful assistance, for sporty start-up, optimal assistance on all types of terrain
TURBO	Red	Maximum assistance up to high pedalling frequencies, for sport riding

Table 21: Overview of level of assistance

2. ABS indicator (optional)

The ABS indicator lights up on pedelecs with an ABS system when they start up.

The ABS will switch off if the pedelec reaches a speed of 6 km/h.

If there is a fault, the ABS indicator lights up together with the indicator of the selected level of assistance, which will flash orange.

Press the Select button to acknowledge the fault and the flashing indicator for the selected level of assistance will go out. The ABS indicator remains lit to indicate that the ABS system is not in operation.

3. Battery level indicator (on-board computer)

The battery level indicator (on-board computer) shows the battery charge level. You can also see the battery charge level on the LEDs on the battery itself.

Each blue bar on the indicator signals 20% capacity and each white bar 10% capacity. The top bar indicates maximum capacity. The two lower indicators will change colour if the capacity is low:

Bars	Capacity
5 × blue	100 ... 91%
4 × blue + 1 × white	90 ... 81%
4 × blue	80 ... 71%
3 × blue + 1 × white	70 ... 61%
3 × blue	60 ... 51%
2 × blue + 1 × white	50 ... 41%
2 × blue	40 ... 31%
2 × orange	30 ... 21%
1 × orange	20 ... 11%
1 × red	10% ... reserve
1 x red, flashing	Reserve ... empty

The uppermost bar will flash if the battery is charging.

3.4.2.1 System message

The on-board computer indicates whether a critical or less critical error has arisen in the drive system.

The error messages generated by the drive system can be read in the eBike Flow app and by the specialist dealer.

The rider can use a link in the eBike Flow app to display all information on errors and assistance on eliminating errors.

You will find more information and a table containing all system messages in Section 6.2.

3.4.2.2 Creating a user account

The rider needs to register on a PC or their smartphone and create a user account to use all the drive system's functions.

The user account can be used to change settings, analyse routes and ride data and activate premium functions among other things.

3.4.2.3 Software updates

Software updates are automatically transferred to the on-board computer in the background of the Bosch eBike Flow smartphone app as soon as the app is connected to the on-board computer.

Once an update has been completely transferred, this is displayed three times when the on-board computer is restarted.

Alternatively, the user can check whether an update is pending under Settings <My eBike> <Components>.

3.4.2.4 Activity tracking

User recognition is required on a PC or smartphone to record activities.

The rider needs to agree to location data being saved on the portal or the app to record activities. Only then will all activities be displayed on the portal or app.

Your location will only be logged if the on-board computer is connected to the eBike Connect app.

Activities will be displayed after synchronisation in the app and on the portal.

3.4.2.5 Lock function

When the lock function is used, the on-board computer acts in a similar way to a key for the drive system. Once the lock function is switched on, the e-bike drive unit assistance is deactivated by removing the on-board computer. The rider can continue to use the mechanical drive system.

It can then only be activated using the on-board computer belonging to the pedelec. The lock function is linked to the eBike Connect app user account.

The lock function does not provide anti-theft protection; it is more a supplement to a mechanical lock. The lock function does not provide mechanical blocking of the pedelec or similar. It only deactivates assistance from the drive unit.

If third parties are to have temporary or permanent access to the pedelec, the lock function must be deactivated in the eBike Connect app.

When activating and deactivating the lock function, the drive system emits audible lock signals. The audible feedback signal is activated by default. The feedback signal can be deactivated under SETTINGS <My eBike>.

3.4.3 BOSCH display, Intuvia 100

The display is controlled on the LED Remote on-board computer.



Figure 55: Intuvia 100 display

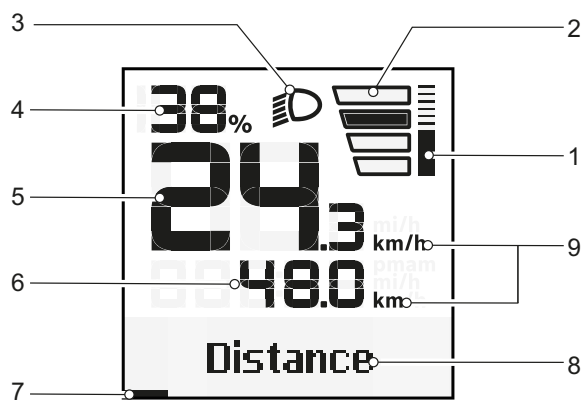

Figure 56: Overview of start screen

- 1 Motor power indicator
- 2 Selected level of assistance indicator
- 3 Riding light symbol
- 4 Battery level indicator (display screen)
- 5 Speed indicator
- 6 Values indicator
- 7 Guidance bar
- 8 Text display/shift recommendation
- 9 Motor power indicator

1 Motor power indicator

The motor power used is displayed as a bar. The maximum motor power depends on the selected level for assistance.

2 Selected level of assistance indicator

The higher the selected level of assistance, the more the drive system assists with pedalling.

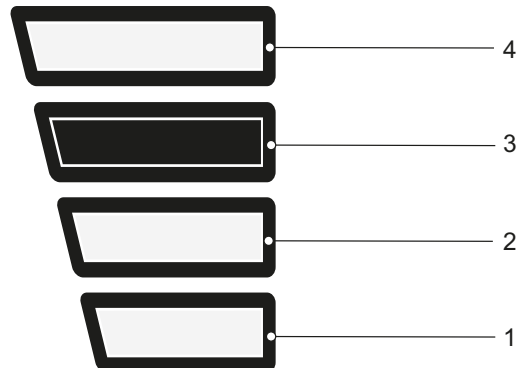



Figure 57: Selected level of assistance

Level of assistance	Use
NO SCREEN DISPLAY	The motor assistance function is switched off. The pedelec can be used like a normal bicycle by simply pedalling.
1	Limited assistance with maximum efficiency for maximum range
2	Constant assistance, for long-range tours
3	Powerful assistance, for sporty start-up, optimal assistance on all types of terrain
4	Maximum assistance up to high pedalling frequencies, for sport riding

Table 22: Overview of level of assistance

3 Riding light symbol

 The riding light symbol is shown when the riding light is on.

4 Battery level indicator (display screen)

If the on-board computer is removed from its mount, the last battery level message is saved.

5 Speed indicator

The speed is displayed either in km/h or mph.

6 Values indicator

The following functions can be selected on the Values screen:

Function	Explanation
DISTANCE	Distance travelled since the last reset
RIDING TIME	Riding time since the last reset
TIME	Current time
RANGE	Expected range of the available battery charge (under constant conditions such as level of assistance, route profile, etc.)
AVG. SPEED	Average speed reached since the last reset
MAX. SPEED	Maximum speed reached since the last reset
TOTAL DISTANCE	Displays the total distance travelled with the pedelec (cannot be reset)

Table 23: Overview of selectable functions

7 Guidance bar

8 Text display/shift recommendation

The title screen indicates the page name and the displayed function.

The shift recommendation is also displayed here.

9 Unit of speed

The unit of speed is displayed either in km/h or mph.

3.4.3.1 Settings

The following system relevant values can be changed in the settings by the LED Remote. The settings menu structure is customised and may change when components or services are added. The settings menu is only shown when stationary.

Submenu	Explanation
Change/exit basic settings	
<Language>	Sets preferred display language
<Units>	Sets speed and distance to kilometres or miles
<Time>	Adjusts the clock
<Time format>	Sets to 12- or 24-hour format
<Shift recommendation>	Switches shift recommendations on or off
<Backlight>	Sets duration of backlight activation
<Brightness>	Adjusts the display brightness
<Settings reset>	Resets all settings to their factory settings
<Certifications>	

Table 24: Basic menu structure for Intuvia 100

The following system and service-relevant values can be read and changed in the eBike Flow app. The settings menu structure is customised and may change when components or services are added.

Menu	Submenu
	→ <Wheel circum.>
	→ <Range reset>
	→ <Auto trip reset>
	→ <Hours of operation>
	→ <BOSCH components used>

Table 25: Adjustable and viewable values for the Intuvia 100 display in the eBike Flow app

3.4.4 Handbrake

There is a handbrake on the left and right of the handlebars.

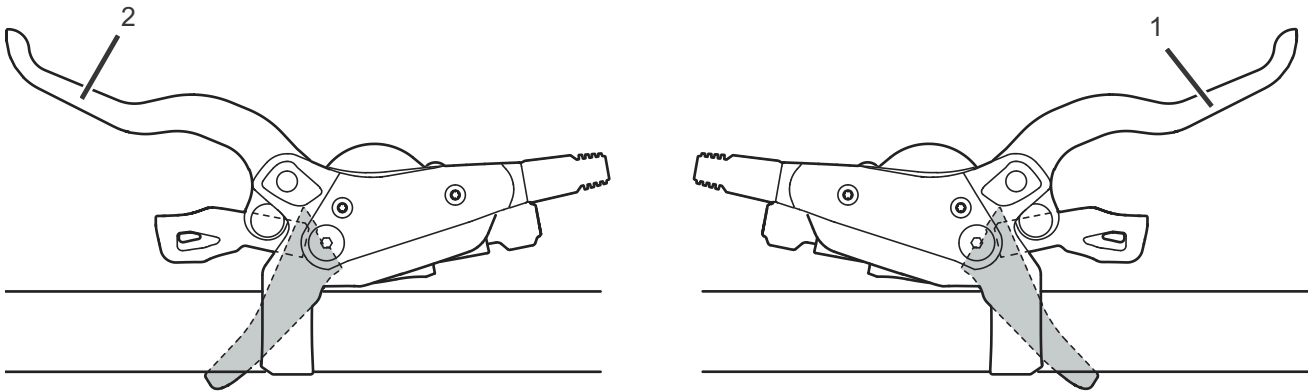

Figure 58: Front wheel (2) and rear (1) brake levers – Shimano brake used as an example

The left handbrake (2) controls the front wheel brake.

The right handbrake (1) controls the rear wheel brake.

3.4.5 Suspension and damping

3.4.5.1 Air valve and sag setting wheel

SR SUNTOUR

Model	AIR EQ	AIR	COIL Adjustable	COIL
	Air valve (fork)	Air valve (fork)	Sag setting wheel	Sag setting wheel
Suspension	Air suspension	Air suspension	Steel spring	Steel spring
				
Rux		x		
Durolux	x			
Auron	x			
ZERON35		x	x	
Axon		x		
Epixon9	x			
Raidon		x		
XCR		x	x	
XCM		x	x	
XCT		x	x	
XCE			x	
M3010			x	x
Mobie45/34/25		x	x	
Mobie35	x			
MobieA32			x	
GVX		x		
NRX		x	x	
NCX32/NCX/TR-HSI		x	x	
NVX			x	
NEX			x	
CR			x	x

Table 26: SR Suntour sag setting wheel depending on suspension fork

3.4.5.2 Damper adjuster





Model	R2C2 RC2	3CR	2CR	RC
				
Remote control	No	No	No	No
Fork				
Rux	O			
Durolux	O			O
Auron	O			
Mobie35		O	O	
Mobie34			x	
Aion				O
Zeron35				x

Table 27: Fork lock by suspension fork

x = present

O = present in PCS piston

Model	RLRC	LORC	RLR	LOR
				
Remote control	Yes	No	Yes	No
Fork				
Auron	O	O		
Axon	x O	x O		
Aion			O	O
Zeron35			x	x
Axon			x	x
Epixon9			x	x
Raidon			x	x
XCR			x	x
XCM				x
Mobie25/45			x	x
GVX			x	x
NRX			x	x

Table 28: Fork lock by suspension fork

x = present

O = present in PCS piston

Model	RL	LO	NLO	HLO
				
Remote control	Yes	No	No	Yes
Fork				
XCR	x	x		
XCM	x	x	x	x
XCT			x	x
Mobie34 CGO		x		
MobieA32	x	x	x	
NRX	x	x		
NCX32/NCX/TR-HSI	x	x		x
NVX	x		x	
NEX	x		x	x
CR		x		x

Table 29: Fork lock by suspension fork

x = present

3.4.6 Battery level indicator (battery)

Each battery has its own level indicator:

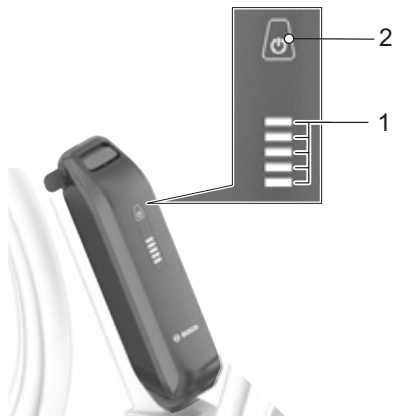

Figure 59: BOSCH PowerPack battery indicator and operating element



Figure 60: BOSCH PowerTube battery indicator and operating element

- 1 On-Off button (battery)
- 2 Battery level indicator (battery)

3.4.6.1 Battery level indicator (battery)

The five green LEDs on the battery level indicator show the charge level when the battery is switched on. Each LED represents 20% of battery capacity.

LED 1,2,3,4,5	Battery level
● ● ● ● ●	100 ... 80%
● ● ● ● ○	79 ... 60%
● ● ● ○ ○	59 ... 40%
● ● ○ ○ ○	39 ... 20%
● ○ ○ ○ ○	19 ... 15%
○ ○ ○ ○ ○	5 ... 0%

Figure 61: Battery level indicator

Symbols:



LED on



LED off

All five LEDs will light up when the battery is fully charged. The charge level for the activated battery is also shown on the on-board computer.

If the battery capacity is less than 10%, the last remaining LED indicator will flash.

If the battery level falls below 5%, all the LEDs on the operating status and battery level indicator will go out.

The battery level is still shown on the on-board computer.

3.5 Technical data

3.5.1 Pedelec

Power output/system	250 W (0.25 kW)
Shut-off speed	25 km/h
Charging temperature	0 °C... +40 °C
Operating temperature	-5 °C... +40 °C
Storage temperature	+10 °C... +40 °C

Table 30: Pedelec technical data

3.5.2 Emissions

The safety requirements as per Electromagnetic Compatibility Directive 2014/30/EU have been met. The pedelec and the charger can be used in residential areas without restriction.

A-weighted emission sound pressure level	< 70 dB(A)
Total vibration level for the hands and arms	< 2.5 m/s ²
Highest effective value of weighted acceleration for the entire body	< 0.5 m/s ²

Table 31: Emissions from the pedelec*

3.5.3 Bicycle lighting

Voltage about	12 V
Maximum output	
Front light	17.4 W
Rear light	0.6 W

Table 32: Bicycle lighting

3.5.4 Display BDS3YYY

Output voltage	67 × 74 × 18 mm
Output current, max.	2.5"
Protection class	240× 320

Table 33: Technical data for BOSCH display mount, BDS3YYY display

3.5.5 LED Remote on-board computer

Internal lithium ion battery	3.7 V, 75 mAh
Charging temperature	0 °C... +45 °C
Operating temperature	-5 °C... +40 °C
Storage temperature	+10 °C... +50 °C
Protection class	IP54
Dimensions	74 × 53 × 35 mm
Weight	0.03 kg
Diagnosis interface	
Interface	USB type C®
USB charging cable*	USB type C®
Max. charging current for USB port	600 mA
USB port charge voltage	5 V
BLUETOOTH Low Energy®	
Frequency	2400...2480 MHz
Transmitting capacity	1 mW

Table 34: Technical data for BOSCH LED Remote on-board computer, BRC3600

*Not included in the standard scope of delivery

3.5.6 BOSCH Intuvia 100 display

Dimensions	67 × 74 × 18 mm
Display diagonal length	2.5"
Display resolution	240× 320
Battery	1 × CR2450
Protection class	IP54
Weight about	0.063 kg
Operating temperature*	-5 °C... +40 °C
Storage temperature	+10 °C... +40 °C
Sensor	Brightness sensor
BLUETOOTH Low Energy 5.0®	
Frequency	2400... 2480 MHz
Transmitting capacity	≤1 mW

Table 35: Technical data for BOSCH Intuvia 100 display, BHU3200

* Malfunctions may occur on the display if it is outside its temperature range

3.5.6.1 BOSCH Performance Line CX motor

Maximum continuous power rating	250 W
Max. torque	85 Nm
Max. support	340%
Crank-chainring transmission	1: 1
Max. speed	25 km/h
Nominal voltage	36 V DC
Permitted chainline	47.5 mm 0/+15 mm
Crank interface	ISIS
Crank screws	M15 × 1
IP protection class	IP54
Weight about	3 kg
Operating temperature	-5... +40 °C
Mass	approx. 2.9 kg
Storage temperature	-10... +40 °C

Table 36: Technical data for BOSCH Performance Line CX motor, BDU3740, BDU3741

3.5.7 Rechargeable battery

3.5.7.1 BOSCH PowerTube 500 battery

Nominal voltage	36 V
Nominal capacity	13.4 Ah
Energy	500 Wh
Weight	3.0 kg
Protection class	IP54
Operating temperature	-5 ... +40 °C
Storage temperature	+10 ... +40 °C
Permitted charging temperature range	0 ... +40 °C

Table 37: Technical data for BOSCH PowerTube 500, BBP3750 horizontal, BBP3751 vertical

3.5.7.2 BOSCH PowerTube 625 battery

Nominal voltage	36 V
Nominal capacity	16.7 Ah
Energy	625 Wh
Weight	3.6 kg
Protection class	IP54
Operating temperature	-5 ... +40 °C
Storage temperature	+10 ... +40 °C
Permitted charging temperature range	0 ... +40 °C

Table 38: Technical data for BOSCH PowerTube 625, BBP3760 horizontal, BBP3761 vertical

3.5.7.3 BOSCH PowerTube 750 battery

Nominal voltage	36 V
Nominal capacity	20.1 Ah
Energy	750 Wh
Weight	4.3 kg
Protection class	IP54
Operating temperature	-5 ... +40 °C
Storage temperature	+10 ... +40 °C
Permitted charging temperature range	0 ... +40 °C

Table 39: Technical data for BOSCH PowerTube 750, BBP3770 horizontal, BBP3771 vertical

3.5.7.4 BOSCH PowerPack 400 battery

Nominal voltage	36 V
Nominal capacity	11.1 Ah
Energy	400 Wh
Weight	2.2 kg
Protection class	IP54
Operating temperature	-5 ... +40 °C
Storage temperature	+10 ... +40 °C
Permitted charging temperature range	0 ... +40 °C

Table 40: Technical data for BOSCH PowerPack 500 battery, BBP3540

3.5.7.5 BOSCH PowerPack 500 battery

Nominal voltage	36 V
Nominal capacity	13.8 Ah
Energy	500 Wh
Weight	3.0 kg
Protection class	IP54
Operating temperature	-5 ... +40 °C
Storage temperature	+10 ... +40 °C
Permitted charging temperature range	0 ... +40 °C

Table 41: Technical data for BOSCH PowerPack 500 battery, BBP3550

3.5.7.6 BOSCH PowerPack 600 battery

Nominal voltage	36 V
Nominal capacity	16.6 Ah
Energy	600 Wh
Weight	3.0 kg
Protection class	IP54
Operating temperature	-5 ... +40 °C
Storage temperature	+10 ... +40 °C
Permitted charging temperature range	0 ... +40 °C

Table 42: Technical data for BOSCH PowerPack 600 battery, BBP3560

3.5.7.7 BOSCH PowerPack 800 battery

Nominal voltage	36 V
Nominal capacity	22.2 Ah
Energy	800 Wh
Weight	3.9 kg
Protection class	IP54
Operating temperature	-5 ... +40 °C
Storage temperature	+10 ... +40 °C
Permitted charging temperature range	0 ... +40 °C

Table 43: Technical data for BOSCH PowerPack 800 battery, BBP3580

3.5.8 Tyres

3.5.8.1 SCHWALBE puncture protection level

PPI	Rubber insert	Inserts Combination	Webbing insert
7	SmartGuard®		
6		DualGuard Double Defense®	Tubeless Easy
5	GreenGuard® PunctureGuard		V-Guard
4			RaceGuard®
3	K-Guard		
2			Performance LiteSkin
1			

Figure 62: Classification of puncture protection belts according to puncture protection level (PPL)

	<p>SmartGuard® SmartGuard® comprises a protective belt made of highly elastic special rubber 5 mm thick, which is partly obtained from recycled material.</p>
	<p>DualGuard DualGuard puncture protection technology consists of two layers of special rubber and nylon webbing 2.5 mm thick beneath the tread.</p>
	<p>Double Defense® This combined puncture protection is available in three versions:</p> <ul style="list-style-type: none"> • In the race version, protection is provided by SnakeSkin (all round) and RaceGuard (beneath the tread). • In tour tyres, SnakeSkin acts on the side walls while the high-density V-Guard is attached beneath the tread. • <i>Plus</i> tyres combine one layer of GreenGuard beneath the tread and SnakeSkin on the side walls.
	<p>Tubeless Easy The Tubeless technology, special monofile webbing (SnakeSkin or MicroSkin) prevent air loss and guarantee puncture protection in combination with sealant.</p>

	<p>V-GUARD The V-Guard puncture protection belt comprises lightweight, cut-resistant fibres. Its webbing ensures highly effective puncture resistance for lightweight race and tour tyres.</p>
	<p>GreenGuard® The GreenGuard® puncture belt comprises highly elastic special rubber 3 mm thick, partially made of recycled material, which is positioned on a 67 EPI carcass.</p>
	<p>PunctureGuard The PunctureGuard puncture protection belt consists of a rubber insert 3 mm thick.</p>
	<p>RaceGuard® The RaceGuard® puncture protection belt comprises two criss-crossing nylon webbings, positioned over a 67 EPI carcass.</p>
	<p>K-Guard The K-Guard puncture protection comprises a natural rubber insert, reinforced with Kevlar® fibres. Kevlar® is a high-tech fibre by DuPont, used in many items to obstruct penetrating objects, including in bulletproof vests.</p>
	<p>Performance and LiteSkin Tyres with a 50 EPI carcass - without puncture protection belt.</p>

3.5.9 Saddle

3.5.9.1 BROOKS ENGLAND saddle width

Riding position	
<p>Narrow saddle</p> <p>Sharply inclined upper body, back at an angle of 30°...60°.</p>	<p>Position on trekking bike</p> 
<p>Medium-width saddle</p> <p>Slightly inclined upper body, back at an angle of 60°...70°.</p>	<p>Position on city bike</p> 
<p>Wide saddle</p> <p>Upright, almost vertical posture, back at an angle of almost 90°.</p>	<p>Position on roadster</p> 

Table 44: BROOKS ENGLAND Specifications

3.5.9.2 ERGON

Suitable sit bone distance	
Medium/large	12 - 16 cm
Small/medium	9 - 12 cm

Table 45: ERGON Specifications

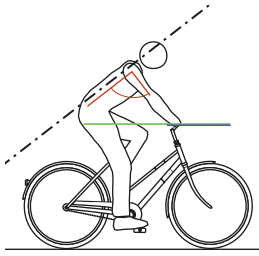
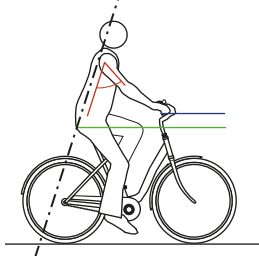
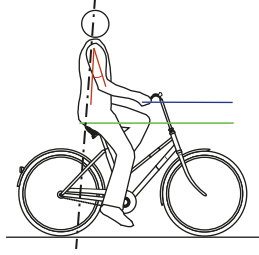
3.5.9.3 SELLE ROYAL saddle width

Riding position	
<p>Athletic</p> <p>Sharply inclined upper body, back at an angle of 30°...60°.</p>	<p>Position on trekking bike</p> 
<p>Moderate</p> <p>Slightly inclined upper body, back at an angle of 60°...70°.</p>	<p>Position on city bike</p> 
<p>Relaxed</p> <p>Upright, almost vertical posture, back at an angle of almost 90°.</p>	<p>Position on roadster</p> 
Suitable sit bone distance	
Small	<11 cm
Medium	11 - 13 cm
Large	>13 cm

Table 46: SELLE ROYAL Specifications

3.5.10 Seat post

3.5.10.1 Suspension seat post LIMOTEC, A3/A3 Plus

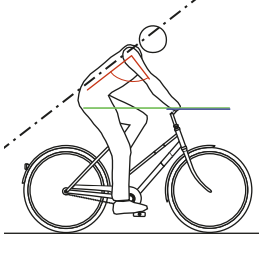
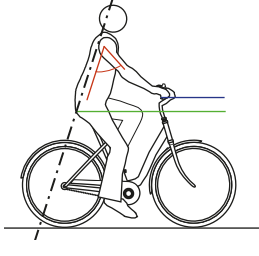
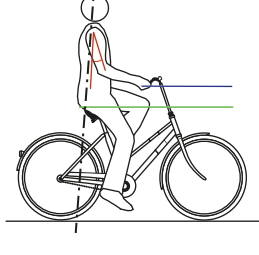
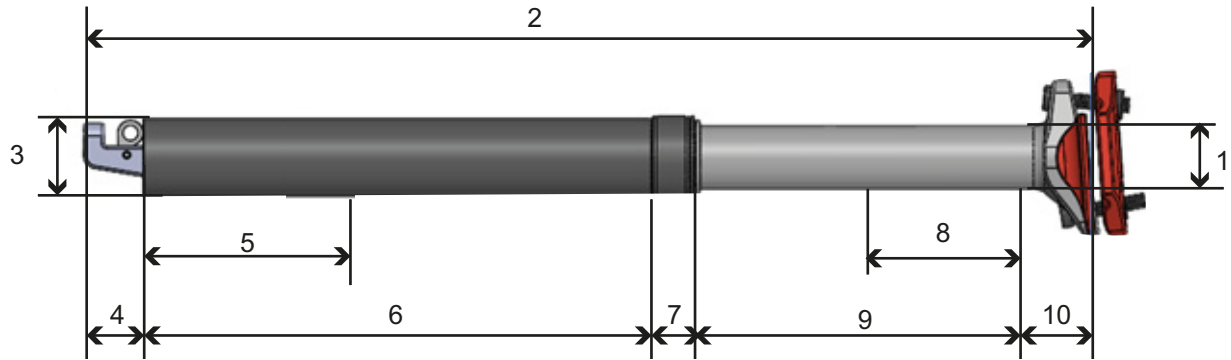

Figure 63: Dimensions of seat post LIMOTEC, A3/A3 Plus

Numbering in drawing		1	2	3	4	5	6	7	8	9	10
Variable type	Maximum body weight [kg]	Ø [mm]	Length [mm]	Ø [mm]	[mm]	Minimum insertion depth [mm]	[mm]	[mm]	Deflection [mm]	Stroke travel [mm]	[mm]
A3											
Soft suspension											
30.9 Ø 40/40 Soft	75	25.6	345	30.9	25	80	178	12	40	80	50
31.6 Ø 40/40 Soft	75	25.6	345	31.6	25	80	178	12	40	80	50
30.9 Ø 40/80 Soft	75	25.6	402	30.9	25	80	205	12	80	120	40
31.6 Ø 40/80 Soft	75	25.6	402	31.6	25	80	205	12	80	120	40
Hard suspension											
30.9 Ø 40/40 Hard	130	25.6	345	30.9	25	80	178	12	40	80	50
31.6 Ø 40/40 Hard	130	25.6	345	31.6	25	80	178	12	40	80	50
30.9 Ø 40/80 Hard	130	25.6	345	30.9	25	80	178	12	80	80	50
31.6 Ø 40/80 Hard	130	25.6	345	31.6	25	80	178	12	80	80	50

Numbering in drawing		1	2	3	4	5	6	7	8	9	10
Variable type	Maximum body weight [kg]	Ø [mm]	Length [mm]	Ø [mm]	[mm]	Minimum insertion depth [mm]	[mm]	[mm]	Deflection [mm]	Stroke travel [mm]	[mm]
A3 Plus											
Soft suspension											
30.9 Ø 40/40 Soft	50 to 110	25.6	345	30.9	25	80	178	12	40	80	50
31.6 Ø 40/40 Soft	50 to 110	25.6	345	31.6	25	80	178	12	40	80	50
30.9 Ø 40/80 Soft	45 to 75	25.6	402	30.9	25	80	205	12	80	120	40
31.6 Ø 40/80 Soft	45 to 75	25.6	402	31.6	25	80	205	12	80	120	40
Hard suspension											
30.9 Ø 40/40 Hard	95 to 130	25.6	345	30.9	25	80	178	12	40	80	50
31.6 Ø 40/40 Hard	95 to 130	25.6	345	31.6	25	80	178	12	40	80	50
30.9 Ø 40/80 Hard	75 to 130	25.6	345	30.9	25	80	178	12	80	80	50
31.6 Ø 40/80 Hard	75 to 130	25.6	345	31.6	25	80	178	12	80	80	50

3.5.10.2 LIMOTEC seat post, A1/A1L

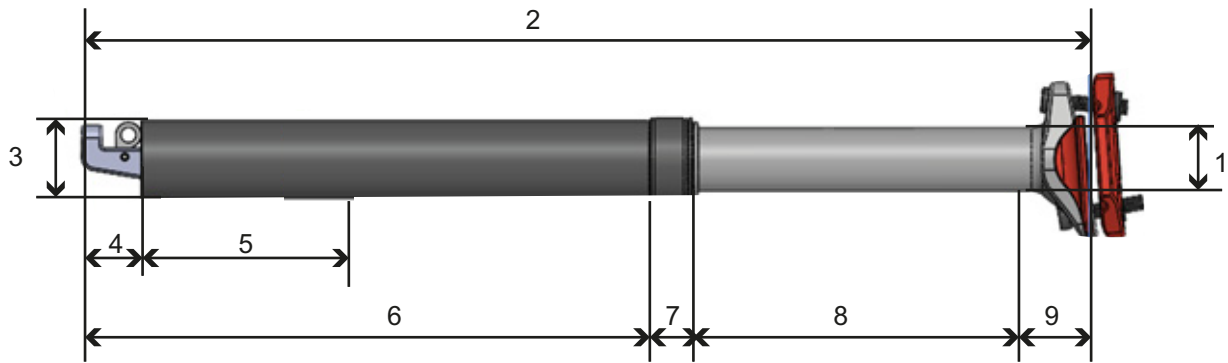

Figure 64: Dimensions of LIMOTEC A1 seat post

Numbering in drawing		1	2	3	4	5	6	7	8	9
Variable type	Maximum body weight [kg]	Ø [mm]	Length [mm]	Ø [mm]	[mm]	Minimum insertion depth [mm]	[mm]	[mm]	Stroke travel [mm]	[mm]
27.2 Ø/75 mm	120	22	310	27.2	25	100	170	12	75	30
30.9 Ø/75 mm	120	25.6	295	30.9	25	80	153	12	75	30
31.6 Ø/75 mm	120	25.6	295	31.6	25	80	153	12	75	30
27.2 Ø/100 mm	120	22	370	27.2	25	100	200	12	100	30
30.9 Ø/100 mm	120	25.6	345	30.9	25	80	178	12	100	35
31.6 Ø/100 mm	120	25.6	345	31.6	25	80	178	12	100	23
34.9 Ø/100 mm	120	25.6	345	34.9	25	80	178	12	100	23
30.9 Ø/125 mm	120	25.6	402	30.9	25	80	205	12	1125	23
31.6 Ø/125 mm	120	25.6	402	31.6	25	80	205	12	125	23
34.9 Ø/125 mm	120	25.6	402	34.9	25	80	205	12	125	
30.9 Ø/150 mm	120	25.6	445	30.9	25	80	235	12	150	
31.6 Ø/150 mm	120	25.6	445	31.6	25	80	235	12	150	
34.9 Ø/150 mm	120	25.6	445	34.9	25	110	235	12	150	
30.9 Ø/170 mm	120	25.6	485	30.9	25	110	248	12	170	
31.6 Ø/170 mm	120	25.6	485	31.6	25	110	248	12	170	
34.9 Ø/170 mm	120	25.6	485	34.9	25	110	248	12	170	
34.9 Ø/200 mm	120	26.2	545	34.9	25	110	278	12	200	

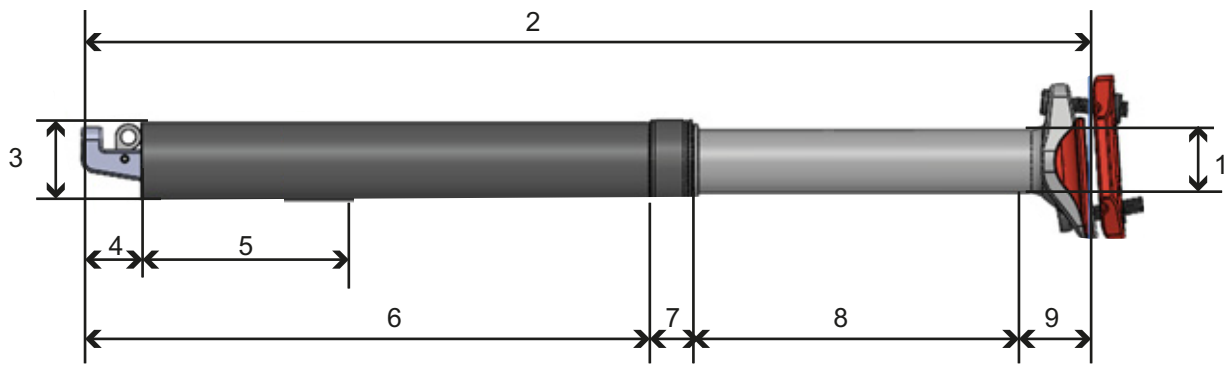



Figure 65: Dimensions of LIMOTEC A1L seat post

Numbering in drawing		1	2	3	4	5	6	7	8	9
Variable type	Maximum body weight [kg]	Ø [mm]	Length [mm]	Ø [mm]	[mm]	Minimum insertion depth [mm]	[mm]	[mm]	Stroke travel [mm]	[mm]
30.9 Ø/75 mm	120	25.6	295	30.9	25	100	178	...	75	...
31.6 Ø/75 mm	120	25.6	295	31.9	25	100	178	...	75	...
30.9 Ø/100 mm	120	25.6	345	30.9	25	100	203	...	100	...
31.6 Ø/100 mm	120	25.6	345	31.9	25	100	203	...	100	...
34.9 Ø/100 mm	120	28.6	345	34.9	25	100	203	...	100	...
30.9 Ø/125 mm	120	25.6	402	30.9	25	100	230	...	125	...
31.6 Ø/125 mm	120	25.6	402	31.9	25	100	230	...	125	...
34.9 Ø/125 mm	120	28.6	402	34.9	25	100	230	...	125	...
30.9 Ø/150 mm	120	25.6	445	30.9	25	80	253	...	150	...
31.6 Ø/150 mm	120	25.6	445	31.9	25	80	253	...	150	...
34.9 Ø/150 mm	120	28.6	445	34.9	25	110	253	...	150	...
30.9 Ø/170 mm	120	25.6	485	30.9	25	110	273	...	170	...
31.6 Ø/170 mm	120	25.6	485	31.9	25	110	273	...	170	...
34.9 Ø/170 mm	120	28.6	485	34.9	25	110	273	...	170	...
34.9 Ø/200 mm	120	28.6	545	34.9	25	110	293	...	200	...

3.5.11 Torque

Model	Torque	Screw
Axle		
Conventional axle nut	35 ... 40 Nm*	
SR SUNTOUR screw-on axle 12AH2 Axle Securing screw	8–10 Nm 5–6 Nm	6 mm hex bit 5 mm hex bit
SR SUNTOUR screw-on axle 15AH2 Axle Securing screw	8–10 Nm 5–6 Nm	6 mm hex bit 5 mm hex bit
Intend Edge Axle Securing screw	3 ... 5 Nm 10 Nm	M6
Rechargeable battery		
BOSCH PowerPack 400/500/600/800 4 × attachment screws for casing base locking mechanism 2 × attachment screws for cover 2 × attachment screws for cover 2 × attachment screw for bracket on cable side 1 × attachment screw for bracket on cable side 2 × attachment screws for bracket on lock side 1 × attachment screws for bracket on lock side	5 Nm 2 Nm 2 Nm 1.3 Nm 5 Nm 5 Nm 1 Nm	Torx® T25, M5 × 20 M3.5 × 12 M3.5 × 12 (pointed) Torx® T15 Torx® T25, M5 × 20 Torx® T25 Torx® T15, M3.5 × 12
On-board computer		
BOSCH Intuvia 100 bracket  Attachment screw 1, M3 × 22 Attachment screw 2, M3 × 14	1 Nm 1 Nm	3 mm hex bit 3 mm hex bit
BOSCH System Controller Attachment screw	0.5 Nm	Torx® T10
BOSCH Mini Remote Attachment screw	0.4 Nm (not 0.6 Nm, as written on mini-remote)	3 mm hex bit
SHIMANO SC-E5003 Attachment screw	0.8 Nm	3 mm hex bit

Brake linings		
SHIMANO Circlip	2–4 Nm	Hex key, 3 mm Slotted-head screwdriver
TEKTRO for hydraulic disc brake system Attachment screws	3–5 Nm	Hex key, 3 mm
Brake cable		
SHIMANO Connecting screw, handbrake	5–7 Nm	Screw wrench, 8 mm
SHIMANO Connecting screw, brake calliper, version for banjo type connection	5–7 Nm 8–10 Nm	Hex key, 3 mm Hex key, 4 mm
SHIMANO Connecting screw for brake calliper, straight version	5–7 Nm	Hex key, 3 mm
SHIMANO for racing bicycles Connecting screw for cable sleeve	5–7 Nm	Screw wrench, 8 mm
TEKTRO for hydraulic disc brake system Bleed valve on brake calliper	4–6 Nm	#
TEKTRO for hydraulic disc brake system Lock screw for the fluid reservoir on the handbrake	2–4 Nm	Torx® T15
Brake calliper		
SHIMANO Adapter attachment screw and brake calliper attachment screw, version with IS brake mount	6–8 Nm	...
SHIMANO Brake calliper attachment screw, post-mount version	6–8 Nm	...
TEKTRO for hydraulic disc brake system Adapter attachment screws	6–8 Nm	#
TEKTRO for hydraulic disc brake system Brake calliper attachment screw	6–8 Nm	Hex key, 5 mm

Brake disc		
SHIMANO for centre lock type Attachment screw, quick release	40–50 Nm	TL-LR15 TL-FC36/TL-LR11 Adjustable spanner
SHIMANO for centre lock type Attachment screw, nut version	40–50 Nm	TL-LR10 Screw wrench
SHIMANO for 5-hole version Attachment screws	2–4 Nm	Star bit [no. 25]
SHIMANO for 6-hole version Attachment screws	2–4 Nm	Star bit [no. 25]
TEKTRO for hydraulic disc brake system Attachment screws	4–6 Nm	Torx® T25
Cantilever brake		
SHIMANO Brake caliper attachment screw	5–7 Nm	Hex key, 5 mm
SHIMANO Attachment screw for brake shoe	8–9 Nm	Hex key, 5 mm Screw wrench, 10 mm
SHIMANO Bowden cable attachment screw	6–8 Nm	Hex key, 5 mm
Dual pivot rim brake		
SHIMANO Attachment screw	8–10 Nm	Hex key, 5 mm
SHIMANO, models with nut Attachment screw	8–10 Nm	Screw wrench, 10 mm
SHIMANO Attachment screw for brake shoe	5–7 Nm	Hex key, 4 mm
SHIMANO, left side Attachment screw for brake cable	6–8 Nm	Hex key, 5 mm
SHIMANO, right side Attachment screw for brake cable	1–1.5 Nm	Hex key, 2 mm
Seat post remote control		
Eightpins Attachment screw Bowden cable fastener	2.5 Nm 5 Nm	4 mm hex bit 3 mm hex bit
Freewheel		
SHIMANO	35 Nm	Multiple freewheel tool TL-FW30

Fork		
Intend Edge Double bridge screw	12 Nm	
SR SUNTOUR Suspension side, top, plastic	5 Nm	
SR SUNTOUR Suspension side, top, aluminium	20 Nm	
SR SUNTOUR Suspension side, bottom	10 Nm	Hex bit (torque)
SR SUNTOUR Suspension side, bottom	8 Nm	Aluminium nut (torque)
SR SUNTOUR Suspension side, bottom, (set deflection)	7 Nm	
SR SUNTOUR Damping side, top, plastic	5 Nm	
SR SUNTOUR Damping side, top, aluminium	20 Nm	
SR SUNTOUR Damping side, bottom, without adjuster	10 Nm	
SR SUNTOUR Damping side, bottom, with adjuster	7 Nm	
SR SUNTOUR Fork head clamps	7 Nm	
SRAM RockShox, 35 Cover cap	28 Nm	Socket nut, 24 mm
SRAM RockShox, Lyrik, ZEB Compression damper cover cap	28 Nm	RockShox cover cap/cassette tool (or standard cassette tool)
SRAM RockShox, Lyrik, ZEB DebonAir+ suspension cover cap	28 Nm	RockShox cover cap/cassette tool (or standard cassette tool)
SRAM RockShox, Lyrik, ZEB Dual Position air suspension cover cap	28 Nm	Socket nut, 24 mm
SRAM RockShox, 35 Attachment screw – compression adjustment ring and remote operation ring	1.4 Nm	2.5 mm hex bit
SRAM RockShox, Lyrik, ZEB Attachment screw – compression adjuster Charger RC (Select)	1.35 Nm	2.5 mm hex bit
SRAM RockShox, Lyrik, ZEB Attachment screw – compression adjustment ring Charger RC (Select)	0.75 ... 1.1 Nm	2.5 mm hex bit
SRAM RockShox, 35 Attachment screw – deflection adjustment ring (Dual Position Coil)	1.35 Nm	2.5 mm hex bit

SRAM RockShox, Lyrik, ZEB ButterCup housing guide rod end plate - end plate to guide rod - air suspension and damper	3.3 Nm	Torx® T25
SRAM RockShox, Lyrik, ZEB ButterCup housing (top) to ButterCup housing (bottom) – air suspension and damper	3.3 Nm	23 mm spanner head
SRAM RockShox Bottomless Tokens	4 Nm	8 mm socket nut and 24 mm hex bit
SRAM RockShox, Lyrik, ZEB Sealing head (rebound) for damper cartridge barrel cover cap – Charger RC (Select), Rush RC (Base)	2 Nm	10 mm socket nut
SRAM RockShox, Lyrik, ZEB Pressure relief valve (PRV) and stopper	9 Nm	19 mm spanner head
SRAM RockShox Locking screw – remote control stop ring	Hand-tight or 0.1 ... 0.3 Nm	2 mm hex bit
SRAM RockShox, Lyrik, ZEB Clamping screw – rebound adjuster ring	0.84 Nm	2.5 mm hex bit
SRAM RockShox, Lyrik, ZEB Air suspension guide rod insert (Select+, Select, Base – only DebonAir+)	3.3 Nm	5 mm hex bit
SRAM RockShox, Lyrik, ZEB Cam adjuster clamping screw – compression damper adjuster (HSC) × 2	0.56 Nm	2.5 mm hex bit
SRAM RockShox Lower screws	6.8 Nm	5 mm hex bit

Handbrake		
SHIMANO Attachment screw	6–8 Nm	Hex key, 4 mm Hex key, 5 mm
SHIMANO Attachment screw, BL-M987/ BL-M9000/BL-M9020	4–6 Nm	Hex key, 4 mm
SHIMANO, lever for disc brake Bleed nipple	4–6 Nm	Socket wrench, 7 mm
SHIMANO, lever for disc brake Bleed screw	0.3–0.5 Nm	...
TEKTRO for hydraulic disc brake system Attachment screws	5–7 Nm	Hex key, 4 mm
Chainring		
SHIMANO, for MTB/trekking Largest chainring/medium- sized chainring Smallest chainring	14–16 Nm 16–17 Nm	 ...
SHIMANO, single version Attachment screw for crank/ chainring	12 ... 14 Nm	5 mm hex key/star bit [No. 30]
SHIMANO, dual version Largest chainring Smallest chainring	12 ... 14 Nm 16–17 Nm	5 mm hex key/star bit [No. 30] 5 mm hex key/star bit [No. 30]
SHIMANO, triple design Largest chainring/medium- sized chainring Smallest chainring	12 ... 14 Nm 16–17 Nm	5 mm hex key/star bit [No. 30] 5 mm hex key/star bit [No. 30]
SHIMANO, FC-M8000, single version Attachment screw for crank/ chainring	12 ... 14 Nm	Star bit [no. 30]
SHIMANO, FC-M8000, dual version Largest chainring Smallest chainring	12 ... 14 Nm 16–17 Nm	Star bit [no. 30] Star bit [no. 30]
SHIMANO, FC-M8000, triple version Largest chainring/medium- sized chainring Smallest chainring	10 ... 12 Nm 16–17 Nm	Star bit [no. 30] Star bit [no. 30]
Chain guard		
Chain guard for BOSCH Motor BDU37xx Attachment screws	max. 10 Nm	M6 × 10; head: max. 5 mm; length: max. 8.5 mm

Crank bearing/crank set		
Conventional cartridge crank bearing	35–45 Nm	...
SHIMANO, HOLLOWTECH li/two-part crank set Linker for adapter and inner sleeve	35–50 Nm	TL-FC24/TL-FC25/TL-FC32/TL-FC36
SHIMANO, HOLLOWTECH li/two-part crank set Cap	0.7–1.5 Nm	TL-FC16 / TL-FC18
SHIMANO, HOLLOWTECH li/two-part crank set Screw for left-hand crank arm	12–14 Nm	Hex key, 5 mm
SHIMANO, OCTALINK model Linker for adapter and main body	50–70 Nm	TL-UN74-S/ TL-UN66
SHIMANO, OCTALINK model Crank set	35–50 Nm	Hex key, 8 mm Hex key, 10 mm
SHIMANO, SQUARE model Linker for adapter and body	50–70 Nm	TL-UN74-S
SHIMANO, SQUARE model Crank set	35–50 Nm	Hex key, 8 mm
Handlebars		
Clamping screw, conventional	5 ... 7 Nm*	
CONTROL TECH, handlebar clamp with one or two screws	14 ... 16 Nm	
SHIMANO, handlebar clamp with one or two screws	20 ... 29 Nm	
Motor		
BOSCH motor BDU37xx 6 x attachment screws for motor	20 ± 2 Nm	Torx Plus® P40, M8 × 16 
Motor cover		
BOSCH motor cover BDU37xx Attachment screws for lower motor cover	Initial fitting: 3 ± 0.5 Nm Retrofit: 2 ± 0.5 Nm	Torx® TX 20
Attachment screws for motor cover	Initial fitting: 3 ± 0.5 Nm Retrofit: 2 ± 0.5 Nm	Torx® TX 20, 4 × 8 mm

Hub		
SHIMANO quick release version FH-M3050, FH-M4050, FH-MT200-B, FH-MT400, FH-MT400-B, FH-MT500, FH-MT500-B, FH-MT510, FH-MT510-B, FH-RM33, FH-RM35, FH-TX505, FH-TY505, FH-UR600 HB-M3050, HB-M4050, HB-MT200, HB-MT400, HB-MT400-B, HB-RM33 HB-TX505 SLX FH-M7000, FH-M7010, FH-M7010-B HB-M7000, HB-M7010, HB-M7010-B DEORE FH-M618, FH-M618-B, FH-M6000, FH-M6010, FH-M6010-B, HB-M618, HB-M618-B, HB-M6000, HB-M6010, HB-M6010-B Brake disc attachment screw	40 Nm	Adjustable spanner and special tool TL-LR15 (SHIMANO)
SHIMANO E-THRU quick release axle Retaining ring for brake disc	40 Nm	Special tool TL-FC36 (SHIMANO)
SHIMANO, FH-M3050, FH-M4050, FH-M7000, FH-M6000, FH-RM33, FH-RM35, FH-UR600 Attachment screw, freewheel body	35 ... 50 Nm	10 mm hex bit
SHIMANO, FH-MT200, FH-TX505, FH-TY505 Attachment screw, freewheel body	147 ... 200 Nm	12 mm hex bit
SHIMANO, FH-M7010, FH-M7010-B, FH-M6010, FH-M6010-B, FH-M618, FH-M618-B, FH-MT400, FH-MT400-B, FH-MT500, FH-MT500-B, FH-MT510, FH-MT510-B Lock nut	15 ... 20 Nm	Hub spanner, 17 mm
SHIMANO, HB-M7000, HB-M6000, HB-M4050 Lock nut	10 ... 15 Nm	Hub spanner, 13 mm and 17 mm
SHIMANO, HB-M7010, HB-M7010-B, HB-M6010, HB-M6010-B, HB-M618, HB-M618-B, HB-MT400, HB-MT400-B Lock nut	21 ... 26 Nm	Hub spanner, 22 mm
SHIMANO hub dynamo E2 model	20 - 25 Nm	Screw wrench
SHIMANO hub dynamo J2 model	20 Nm	Screw wrench
SHIMANO hub dynamo J2-A model	20 Nm	Screw wrench

Pedal		
Pedal, conventional	33 ... 35 Nm	Screw wrench, 15 mm
SHIMANO Attachment screw	35–55 Nm	Screw wrench, 15 mm
Seat post		
by.schulz, G1 M8 seat clamp screw M5 fixing grub screws	20 ... 24 Nm 3 Nm	2.5 mm hex bit
by.schulz, G2 M6 seat clamp screw M5 fixing grub screws	12 ... 14 Nm 3 Nm	2.5 mm hex bit
Eightpins NGS2 Seat post axle Slipper clutch Valve cover Postpin axle Rear clamping screw (saddle) M5 attachment screw for outer sleeve	8 Nm 18 Nm 0.5 Nm 8 Nm 8 Nm 0.5 Nm	6 mm hex bit 3 mm hex bit 5 mm hex bit 5 mm hex bit 3 mm hex bit 3 mm hex bit
Eightpins H01 Seat post axle Slipper clutch Valve cover Postpin axle Rear clamping screw (saddle) M5 attachment screw for outer sleeve	8 Nm 18 Nm 0.5 Nm 8 Nm 8 Nm 0.5 Nm	6 mm hex bit 3 mm hex bit 5 mm hex bit 5 mm hex bit 3 mm hex bit 3 mm hex bit
LIMOTEC LimoDP Clamping screw for seat post Clamping screw for saddle	6 ... 7 Nm 7 ... 9 Nm	
SR SUNTOUR suspension seat post Saddle clamp screw M5 fixing grub screws	15 ... 18 Nm 3 Nm	5.0 mm hex bit 2.5 mm hex bit
Shifter		
SHIMANO DEORE SL- M4100 Attachment screw	3 Nm	4 mm hex bit
SHIMANO DEORE SL- M5100 Attachment screw	3 Nm	4 mm hex bit
SHIMANO DEORE SL- M6100 Attachment screw	3 Nm	4 mm hex bit
SHIMANO DEORE XT SL- M8100 Attachment screw	3 Nm	4 mm hex bit
SHIMANO DEORE XT SL- M8130 Attachment screw	3 Nm	4 mm hex bit
SHIMANO, SLX SL-M7100 Attachment screw	3 Nm	4 mm hex bit
SHIMANO XTR SL-M9100 Attachment screw	3 Nm	4 mm hex bit

Rear derailleur		
SHIMANO for MTB/trekking Attachment screw, standard type	8–10 Nm	Hex key, 5 mm
SHIMANO for MTB/trekking Attachment screw with bracket	3–4 Nm	Hex key, 5 mm
SHIMANO for BMX bicycles Attachment screw	3–4 Nm	Adjustable spanner
SHIMANO for MTB/trekking Attachment screw for inner cable	6–7 Nm	Hex key, 4 mm/ Hex key, 5 mm/ Adjustable spanner
SHIMANO for MTB/trekking Attachment screw for the guide pulley	2.5–5 Nm	Hex key, 3 mm
SHIMANO for MTB/trekking Attachment screw for the tensioning roller	2.5–5 Nm	Hex key, 3 mm
SHIMANO for racing bicycles Attachment screw, standard type	8–10 Nm	Hex key, 5 mm
SHIMANO for racing bicycles Attachment screw with bracket	3–4 Nm	Screw wrench
SHIMANO for racing bicycles Attachment screw for inner cable	6–7 Nm	Hex key, 4 mm/ Hex key, 5 mm
SHIMANO for racing bicycles Attachment screw for pulley	2.5–5 Nm	Hex key, 3 mm
Headlight		
FUXON headlight Attachment screw	>5 Nm	...
SUPERNOVA, M99 Pure/ Pure+, V521s Attachment screw	2 Nm	M6 attachment screw, self-locking nut, washer
SUPERNOVA, M99 Pure/ Pure+, V521s Stem screw	6 Nm	
Front derailleur		
SHIMANO for MTB/trekking Attachment screw, clip type, E-type and direct fitting	5–7 Nm	Hex key, 5 mm
SHIMANO for MTB/trekking Inner bearing adapter	35–50 Nm	...
SHIMANO for MTB/trekking Top swing screw, clip type and e-type	5–7 Nm	Hex key, 5 mm/ Screw wrench, 9 mm
SHIMANO for MTB/trekking Down swing screw, clip type, direct fitting	5–7 Nm	Hex key, 5 mm
SHIMANO for racing bicycles Attachment screw	5–7 Nm	Hex key, 5 mm/ Screw wrench, 9 mm
SHIMANO for racing bicycles Attachment screw, Bowden cable	6–7 Nm	Hex key, 5 mm/

V-Brake brake		
SHIMANO Attachment screw for connecting cable	6–8 Nm	Hex key, 5 mm
SHIMANO Brake shoe nut	6–8 Nm	Hex key, 5 mm
SHIMANO Bowden cable attachment screw	6–8 Nm	Hex key, 5 mm
Stem		
FSA, carbon quill stem	9 Nm	15 mm spanner

4 Transporting and storing

4.1 Weight and dimensions for transportation

Weight and dimensions during transport

Not yet available when the instructions were produced

4.2 Designated handles, lifting points

The box does not have any handles.

4.3 Transportation

! CAUTION

Crash caused by unintentional activation

There is a risk of injury if the drive system is activated unintentionally.

- ▶ Remove the battery.

4.3.1 Using the transport securing system

Applicable for pedelec disc brakes only

! CAUTION

Oil leak if no transport securing device

The brake securing device prevents the brakes from being applied accidentally during transportation or shipment. This could cause irreparable damage to the brake system or an oil leak, which will harm the environment.

- ▶ Never push the brake lever when the wheel has been dismantled.
 - ▶ Always use the transport securing system when transporting or shipping.
-
- ▶ Insert the **transport securing devices** between the brake linings.
- ⇒ Transport securing device is squeezed between the two linings and prevents undesired sustained braking which can cause brake fluid to leak out.

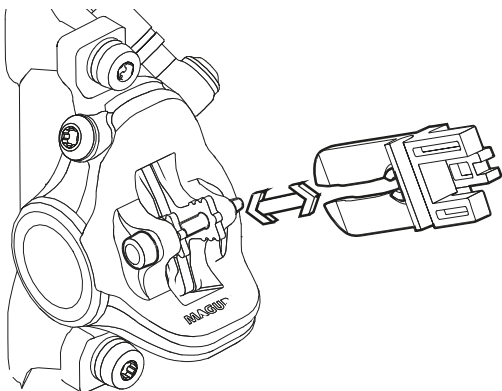

Figure 66: Fastening the transport securing device

4.3.2 Transporting the pedelec

4.3.2.1 By car

Bicycle rack systems which use the handlebars or frame to hold the pedelec in an upside-down position exert inadmissible forces on its components during transportation. This can cause the supporting parts to break.

- ▶ Remove battery and all detachable components (screen, bicycle pump, water bottle and similar) from the pedelec.
- ▶ Transport the battery in a dry, clean position where it is protected from direct sunlight.
- ▶ Never use bicycle rack systems which use the pedelec's handlebars or frame to hold the pedelec in an upside-down position. The specialist dealer will give a consultation on correct selection and safe use of a rack system.
- ▶ Take into account the weight of the ready-to-use pedelec when transporting it.

4.3.2.2 By train

Pedelecs can usually be transported in trains with a bicycle compartment.

- ✓ If you want to take your e-bike with you on the train, you should take into account that routes to platforms are not always barrier-free. You should thus allow enough time to get on and off the train.

- 1 Buy a bicycle ticket for the pedelec.
- 2 Fasten the pedelec securely in the compartment.
- 3 Take a seat in the passenger carriage.

It is possible to take a pedelec on certain high-speed train routes. The battery must remain firmly mounted during the journey and must not be charged.

4.3.2.3 By local transport

You can normally take pedelecs on local public transport, e.g. by bus or suburban rail, if you purchase a bike ticket. There may be times when this is not permitted. Local transport companies will give you relevant information.

4.3.2.4 By long-distance bus

Pedelecs can usually be taken on the long-distance bus for an extra charge, although places are limited. It is best to book early. However, not every bus line accepts pedelecs. You should check with the long-distance bus provider concerned before travelling.

4.3.2.5 On flights

It is forbidden to transport rechargeable batteries on passenger planes. Most airlines won't even transport pedelecs without batteries on passenger planes either.

It is a good idea to find out about pedelec leasing at your destination in advance if you wish to use a pedelec while on holiday. This way, you won't need to forgo pedelec riding fun during your holidays.

4.3.3 Shipping a pedelec

- ▶ When shipping the pedelec, we recommend that you have the specialist dealer place it in proper packaging.

4.3.4 Transporting the battery

Batteries are subject to hazardous goods regulations. Undamaged batteries may be transported by private persons in road traffic.

Commercial transport operators must comply with regulations on packaging, labelling and the transportation of hazardous goods. Open contacts must be covered and the battery securely packaged.



4.3.5 Shipping the battery

The battery is considered a hazardous good and only trained persons may pack and ship a battery. Contact specialist dealer.

- ▶ If you have a valid hazardous good certificate, pack and ship the battery as per current hazardous goods regulations.



4.4 Storing

- ▶ Always store pedelec, battery, on-board computer, display and charger separately.

Storage temperature	+10... +40 °C
Humidity	30%...85%
Ideal storage temperature	+10... +20 °C
Optimum air humidity	30%...60%



Table 47: Ambient conditions for storage

- ▶ Temperatures under -5 °C or over +40 °C and air humidity over 85% must generally be avoided.
- ▶ Store pedelec, on-board computer, battery and charger in a place which is
 - ▶ dry
 - ▶ clean
 - ▶ protected from direct sunlight
 - ▶ well-ventilated
 - ▶ Never store in the open air.

4.4.1 Pedelec

Store pedelec in a garage or a dry basement.

4.4.2 On-board computer, display and charger

Store on-board computer, display and charger in a dry environment at room temperature.

4.4.3 Rechargeable battery

- ▶ Storage at about 10 °C to 20 °C is beneficial to a long battery life.
- ▶ Store batteries in rooms with smoke detectors. A protection box with an electrical connection is an optimal solution.
- ▶ Never store batteries near to inflammable or easily combustible objects.
- ▶ Never store batteries near sources of heat.

New battery

- ✓ Inspect battery for damage after delivery.
- ⇒ If the batteries are damaged, observe Section 2.1 Handling a damaged or faulty battery during storage and disposal.
- ✓ It is best to store damage-free batteries separately for 24 hours and keep them under observation.
- 4 If no faults arise, store batteries in a separate room with fire doors and smoke detectors. If the battery is stored in its original packaging, stack a maximum of five batteries on top of one another.

Battery in use

- 1 Immediately remove batteries from customer pedelec before maintenance or repair.

Treat unchecked batteries as faulty batteries.

When storing batteries, treat them in the same way as a damaged or faulty battery until they are inspected.

- 2 Inspect battery.
- 3 Battery are stored as agreed with the insurance company.

Faulty battery

- 4 If batteries are faulty, observe Section 2.1 Handling a damaged or faulty battery during storage and disposal.

4.4.4 Break in operation

Notice

The battery discharges when not in use. This can cause irreparable damage to the battery.

- ▶ The battery must be recharged every 6 months.

The battery may become damaged if it is connected permanently to the charger.

- ▶ Never connect the battery to the charger permanently.

If the battery is stored for a longer period of time when empty, it can become damaged despite low self-discharge and the storage capacity can be greatly reduced

- ▶ Store battery with at least 30% charge.
- ▶ Charge components every 3 months for around 1 hour via the USB diagnostic interface to avoid an extremely low charge level in the integrated battery in the LED remote and the system controller.

- ▶ Remove the on-board computer and battery from their mount if the pedelec is not going to be used for up to four weeks.
- ▶ If the pedelec is removed from service for longer than four weeks, you need to prepare it for a break in operation.

4.4.4.1 Preparing a break in operation

- ✓ Remove the rechargeable battery from the pedelec.
- ✓ Charge battery between 30% and 60% so that 2 or 3 LEDs light up on the battery level indicator.
- ✓ The pedelec needs to be cleaned with a damp cloth and preserved with wax spray. Never wax the friction surfaces of the brake.
- ✓ Before longer periods without use, it is recommended to have the specialist dealer carry out maintenance and basic cleaning and apply preservative agent.

4.4.4.2 Carrying out a break in operation

- 1 Store the pedelec, battery and charger in a dry, clean environment. We recommend storing them in uninhabited rooms with smoke alarms. Dry locations with an ambient temperature between 10 °C and 20 °C are ideal.
- 2 Check the battery level after 6 months. If only one LED on the battery level indicator lights up, recharge the battery to between 30% and 60%.



5 Assembly

WARNING

Risk of eye injury

Problems may arise if components are set incorrectly. They may cause serious injuries to the face.

- ▶ Always wear safety glasses to protect eyes when assembling pedelecs.

CAUTION

Crash and crushing hazard caused by unintentional activation

There is a risk of injury if the electric drive system is activated unintentionally.

- ▶ Remove the battery.

- ✓ Assemble the pedelec in a clean, dry environment.
- ✓ The work environment temperature should be between 15 °C and 25 °C.
- ✓ The fitting stand used must be approved for a maximum weight of least 30 kg.

5.1 Unpacking

The packaging material consists mainly of cardboard and plastic film.

- ▶ Dispose of the packaging in accordance with the regulatory requirements (see Section 10).
- ⇒ Pedelecs are fully assembled in the factory for test purposes and then dismantled for transportation. The pedelec is 95% to 98% pre-assembled.

Scope of delivery

<input type="checkbox"/>	1 pre-assembled pedelec
<input type="checkbox"/>	1 front wheel
<input type="checkbox"/>	2 pedals
<input type="checkbox"/>	2 quick releases (optional)
<input type="checkbox"/>	1 charger
<input type="checkbox"/>	1 set of operating instructions on CD
<input type="checkbox"/>	1 battery (supplied separately from the pedelec)

5.2 Required tools

The following tools are required to assemble the pedelec:

	Knife
	Ring spanners 8 mm, 9 mm, 10 mm, 13 mm, 14 mm and 15 mm
	Torque wrench Working range 5... 40 Nm
	by.schulz handlebars: TORX® bits: T50, T55, and T60
	Hex key 2 mm, 2.5 mm, 3 mm, 4 mm, 5 mm, 6 mm and 8 mm
	Cross-recess screwdriver
	Slotted-head screwdriver

Table 48: Tools required for assembly



5.3 Commissioning

Only trained specialist staff may perform initial commissioning since initial commissioning of the pedelec requires special tools and specialist knowledge.

Experience has shown that a pedelec which has not yet been sold is automatically handed to customers as soon as it appears ready to ride.

- ▶ It makes sense to prepare each pedelec so that it is fully ready for use immediately after being assembled.
- ▶ The assembly report (see Section 11.2) describes all safety-relevant inspections, tests and maintenance tasks.
- ▶ All assembly work must be completed to ensure the pedelec is ready to ride.
- ▶ Complete an assembly report to document quality assurance (see Section 11.1).

5.3.1 Checking the battery

The battery must be checked before it is charged for the first time.

- ▶ Press the **On-Off button (battery)**.
- ⇒ If none of the LEDs on the **battery level indicator** light up, the battery may be damaged.
- ⇒ The battery may be fully charged if at least one, but not all, of the LEDs on the **battery level indicator** lights up.



5.3.2 Preparing the battery

5.3.2.1 Retrofitting the PowerTube adapter

Only applies to pedelecs with this equipment

The PowerTube Adapter 400 or 500 needs to be altered to use the BOSCH PowerTube 625 battery mount.

- 1 Use a TORX® T25 wrench to undo the screws in the battery mount.

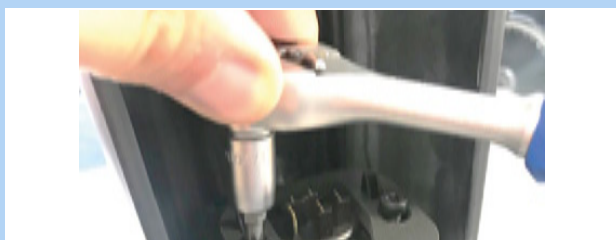

Figure 67: Undoing screws on battery mount

- 2 Use ratchet to remove the two 4 mm hexagon screws from the PowerTube adapter. You can use a hexagonal key to remove the screws if you don't have a small ratchet.



Figure 68: Removing the 4 mm hexagon screws

- 3 Use ratchet to remove the two 4 mm hexagon screws from the PowerTube adapter.

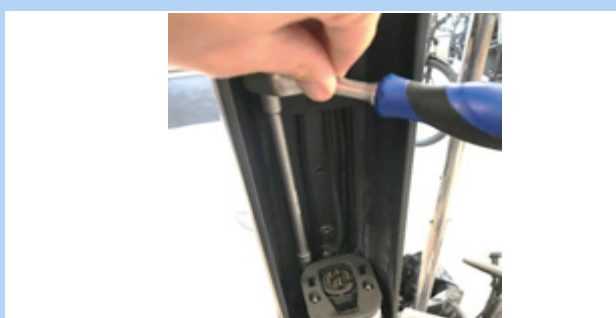

Figure 69: Removing hexagon screws

- 4 Remove the PowerTube adapter.



Figure 70: Pulling out the PowerTube adapter

- 5 Use adapter plates to adjust the distance if necessary.



Figure 71: Fitted adapter plates

- 6 Use a TORX® T25 wrench to fasten the screws into the battery mount.

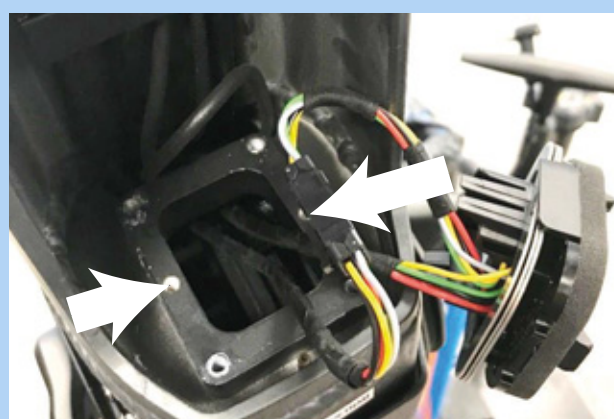

Figure 72: Fastening the battery mount



5.3.2.2 Fit battery cover onto Bosch PowerTube 625 battery (horizontal)

Only applies to pedelecs with this equipment

- 1 Detach upper interface (lock side) from the BOSCH PowerTube 625 battery with a TORX® T20 wrench.



Figure 73: Detaching the upper interface

- 2 Screw the battery mounting plate to the BOSCH PowerTube 625 battery with original BOSCH screws (M4 × 8 T20). In doing so, ensure that the removal tab faces the front of the battery.



Figure 74: Fitting the mounting plate

- 3 Press to push the battery cover onto the battery. In doing so, ensure that the **battery On-Off button** fits through its designated slot in the cover.
- ⇒ The battery cover will lock into the fitting grooves on the battery.



Figure 75: Pushing the battery cover onto battery

- ▶ Insert battery into the frame.



5.3.2.3 Fit battery cover onto Bosch PowerTube 500 battery (horizontal)

Only applies to pedelecs with this equipment

- 1 Detach upper interface (lock side) from the BOSCH PowerTube 625 battery with a TORX® T20 wrench.



Figure 76: Detaching the upper interface

- 2 Fasten PowerTube extension to the BOSCH PowerTube 500 battery using the two M4 x 8 T20 screws supplied. In doing so, ensure that the closed side faces the front of the battery, towards the **battery On-Off button**. The smooth upper surface of the PowerTube extension must face upwards, away from the battery.



Figure 77: Fitting the PowerTube extension

- 3 Screw the battery mounting plate onto PowerTube extension with original BOSCH screws (M4 x 8 T20). To do so, use PowerTube extension screw plate as counter support. When positioning the extension, ensure that the removal tab faces the front of the battery.



Figure 78: Fastening the battery mounting plate

- 4 Press to push the battery cover onto the battery. In doing so, ensure that the **battery On-Off button** fits through its designated slot in the cover.

⇒ The battery cover will lock into the fitting grooves on the battery.



Figure 79: Pushing the battery cover onto battery

- Insert battery into the frame.



5.3.3 Adjusting the suspension system to body weight

Steel suspension in suspension forks and seat posts are designed to bear body weight. If the body weight is exceeded or not reached, the suspension system will no longer function as intended. This has no effect on the fork's approved load capacity but the suspension system will no longer deflect optimally or it won't deflect at all.

- ▶ Adjust steel suspensions to body weight.

5.3.3.1 Adjusting SR SUNTOUR steel suspension fork to body weight

Not included in price

Unless specified otherwise, SR Suntour forks are supplied from the factory with a medium degree of hardness. A hard and a softer spring stiffness are available so that the suspension fork can be adjusted to the body weight.



Figure 80: SR Suntour coil spring hard

- 1 Ask about body weight before selling the pedelec.
- 2 Ensure it complies with the specifications in chapter 3.5.10.
- 3 If the body weight differs from the specifications, order suitable spring elements from the manufacturer and install them.

5.3.3.2 Adjusting seat post to body weight

Not included in price



Seat post are components that may be replaced after approval by the vehicle or parts manufacturer.

Replacing with different sizes and hardnesses within a product series is permitted for seat posts. Moreover, seat posts may be exchanged if the rearward offset for the series or original range of use is not greater than 20 mm. This is because a change in load distribution outside the intended adjustment range can lead to hazardous steering performance. The seat post length must always be the same when replacing posts.

The correct functioning of the following seat posts depends on the body weight:

- Suspension seat post
- Rhomboid seat post
- Lowerable seat post

- ▶ If the body weight falls below or exceeds the specifications in Section 3.5.10, either the seat post spring or, in the case of integrated seat posts, the complete seat post must be replaced with a seat post from the same product series that is appropriate for the body weight.



5.3.4 Installing the wheel in the SUNTOUR fork

Only applies to Suntour forks with this equipment

5.3.4.1 Screw-on axle (12AH2 and 15AH2)

Only applies to Suntour forks with this equipment

✓ Before installing the wheel, ensure that the O-ring is in the right position on the thread piece.

- 1 Insert the front wheel into the fork ends.
- 2 Insert the axle into the hub on the drive side.

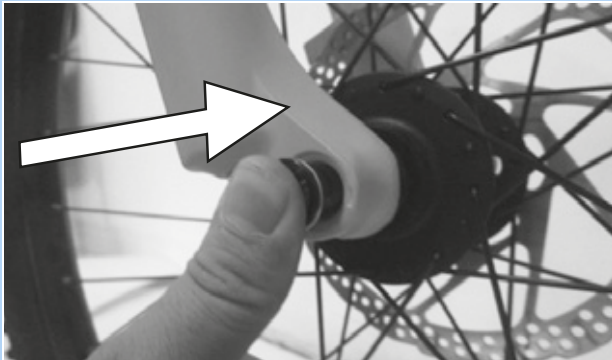

Figure 81: Inserting the axle in the direction of the arrow

- 3 Use a 6 mm hex key to tighten the axle using between 8 and 10 Nm. The axle thread must be visible.



Figure 82: Tighten the axle in the direction of the arrow

- 4 Insert the securing screw on the non-drive side.



Figure 83: Inserting the securing screw

- 5 Tighten the securing screw with a 5 mm hex key using between 5 and 6 Nm.



Figure 84: Tightening the securing screw

⇒ The wheel is now fitted.



5.3.4.2 20 mm cross axle

Only applies to Suntour forks with this equipment

CAUTION

Crash caused by loose cross axle

A faulty or incorrectly installed cross axle may become caught in the brake disc and block the wheel. This will cause a crash.

- ▶ Never fit a defective cross axle.

Crash caused by faulty or incorrectly installed cross axle

The brake disc becomes very hot during operation. Parts of the cross axle may become damaged as a result. The cross axle becomes loose. This will cause a crash with injuries.

- ▶ The cross axle and the brake disc must be opposite one another.

Crash caused by incorrectly set cross axle

Insufficient clamping force will result in unfavourable transmission of force. The suspension fork or the quick release axle may break. This will cause a crash with injuries.

- ▶ Never fasten the cross axle with a tool (e.g. hammer or pliers).

- 1 Insert the cross axle into the hub on the drive side.

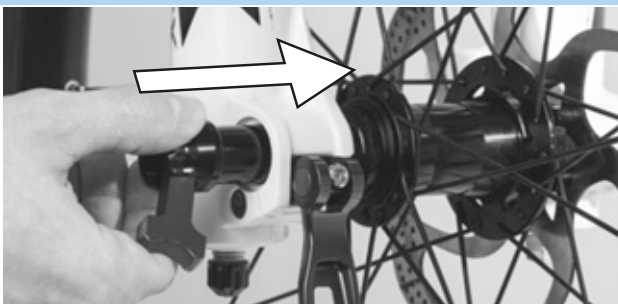

Figure 85: Inserting the cross axle in the direction of the arrow

- 2 Tighten the cross axle with the red handle.

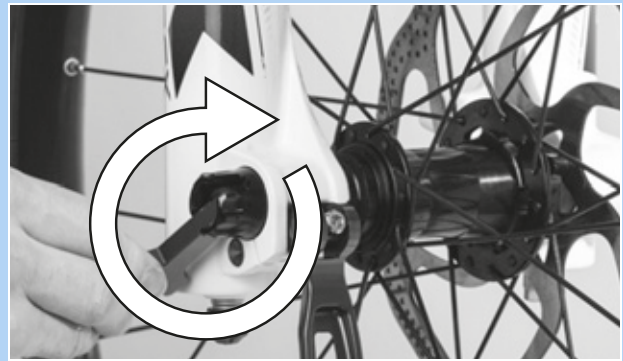

Figure 86: Tighten the axle in the direction of the arrow

- 3 Push red lever into the cross axle.

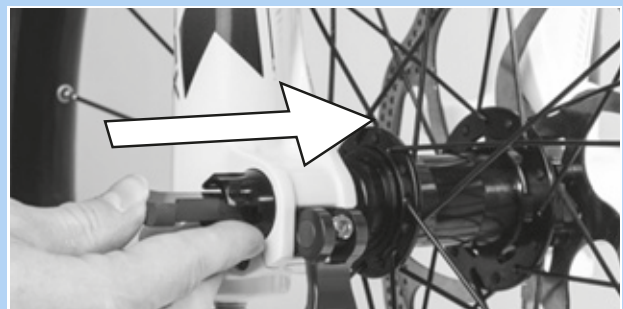

Figure 87: Pushing the red lever in the direction of the arrow

- 4 Closing the quick release lever.

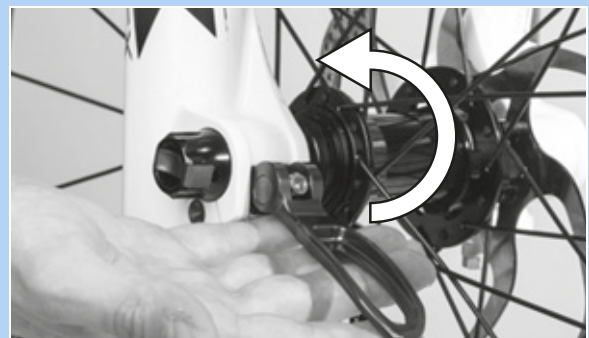

Figure 88: Pressing the quick release lever in the direction of the arrow

⇒ The cross axle is secured.



- 5 Check the position and clamping force of the quick release lever. The quick release lever must be flush with the shock absorber.



Figure 89: Perfect position for the clamping lever

- 6 Use 4 mm hexagon socket spanner to adjust the clamping lever clamping force if required.

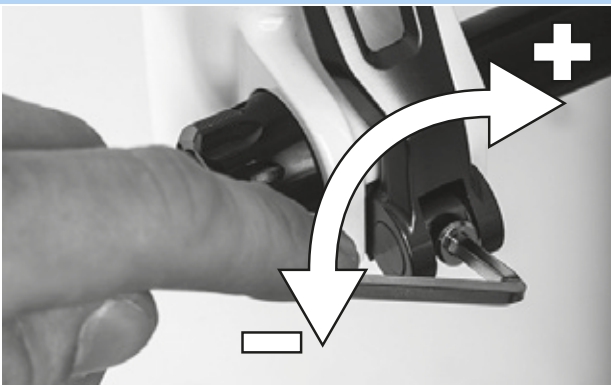

Figure 90: Adjusting the quick release clamping force

- 7 Check the quick release lever position and clamping force.

⇒ The wheel is now fitted.



5.3.4.3 Q-LOC quick release

Only applies to Suntour forks with this equipment

CAUTION

Crash caused by unfastened quick release

A faulty or incorrectly installed quick release may become caught in the brake disc and block the wheel. This will cause a crash.

- ▶ Never fit a defective quick release.

Crash caused by faulty or incorrectly installed quick release

The brake disc becomes very hot during operation. Parts of the quick release may become damaged as a result. The quick release comes loose. This will cause a crash with injuries.

- ▶ The front wheel quick release lever and the brake disc must be situated on opposite sides.

Crash caused by incorrectly set clamping force

Excessively high clamping force will damage the quick release and cause it to lose its function. Insufficient clamping force will result in unfavourable transmission of force. The suspension fork or the quick release may break. This will cause a crash with injuries.

- ▶ Never fasten a quick release using a tool (e.g. hammer or pliers).
- ▶ Only use the clamping lever with the specified set clamping force.

- ✓ Before installing, ensure that the quick release flange is extended. Open the lever fully.

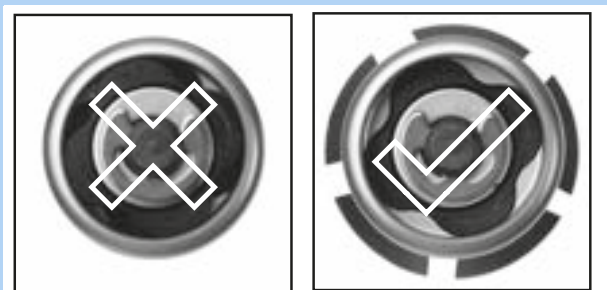

Figure 91: Closed and opened flange

- 1 Push in the quick release until you can hear a click. Make sure that the flange is extended.



Figure 92: Inserting the quick release in the direction of the arrow

- 2 Adjust tensioning with half-open clamping lever until the flange reaches the fork end.

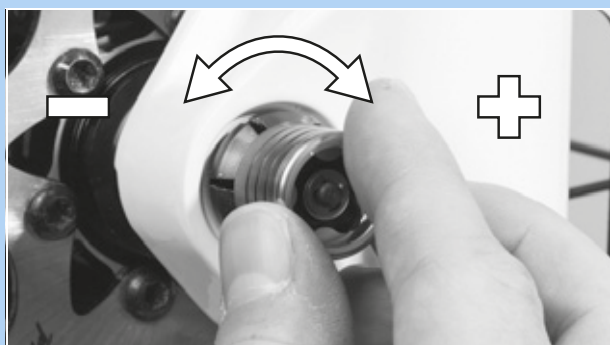

Figure 93: Adjusting the clamping

- 3 Fully close the quick release. Check that it is firmly in place and adjust it on the flange if necessary.



Figure 94: Closing the quick release

⇒ The wheel is now fitted.



5.3.5 Preparing the wheel

There is an arrow on the sides of the tyres with the inscription ROTATION to show the direction of rotation. The inscription says DRIVE on older tyres. The rotation direction arrow indicates the recommended direction of rotation. On road tyres, the direction of rotation is mainly for optical reasons.



Figure 95: Rotation direction arrow

The direction of rotation is much more important on off-road terrain because the tread creates an interlock with the ground. While the rear wheel needs to transmit the drive forces, the front wheel is responsible for transmitting braking and steering forces. Drive and braking forces have different directions of action. This is why some tyres are mounted on the front and rear wheels in opposite directions. On these tyres, there are two rotation direction arrows:

- The FRONT rotation direction arrow indicates the recommended direction of rotation for the front wheel.
- The REAR rotation direction arrow indicates the recommended direction of rotation for the rear wheel.



Figure 96: Rotation direction arrow on MTB tyres

- ▶ The rotation direction arrow must point in the direction of travel when the wheel is placed in the fork.
- ▶ There are also non-directional tyre profiles with no rotation direction arrow.



5.3.6 Fitting the pedals

The pedals have two different threads to ensure they don't come loose while the rider is pedalling.

- The pedal on the left facing the direction of travel has a left-hand thread and is marked L.
- The pedal on the right facing the direction of travel has a right-hand thread and is marked R.

The mark is either on the top end, the axle or the pedal body.



Figure 97: Example of mark on pedals

- 1 Coat threads in both pedals with waterproof grease.
- 2 Turn the pedal marked L anti-clockwise by hand into the crank arm on the left as seen when facing the direction of travel.

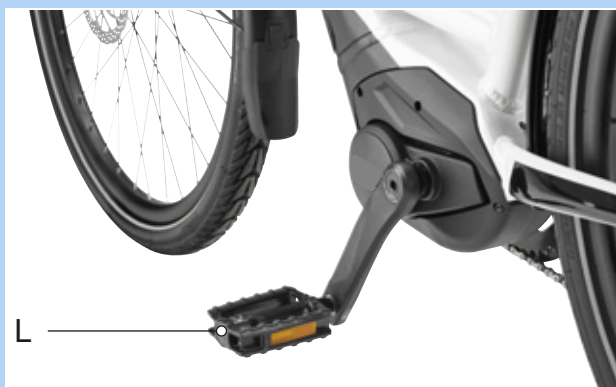

Figure 98: L-pedal in the left-hand crank arm

- 3 Turn the pedal marked R anti-clockwise by hand into the crank arm on the right as seen when facing the direction of travel.



Figure 99: R-pedal in the right-hand crank arm

- 4 Use a 15 mm spanner to fasten the left-hand pedal thread in an anti-clockwise direction and the right-hand pedal in a clockwise direction with a torque between 33 Nm and 35 Nm.



5.3.7 Preparing the LIMOTEC seat post

Only applies to pedelecs with this equipment

- 1 Use the seat height formula to calculate the optimum seat post height for leg length:
Seat height (SH) = inner leg length (I) \times 0.9
- 2 Lower the seat post further into the seat tube
- 3 The seat post Bowden cable must be tightened in the frame up to the remote control to the same length as the seat post was lowered.
- 4 Trim the seat post Bowden cable on the handlebars if necessary.



5.3.8 Checking the stem and handlebars

5.3.8.1 Checking the connections

- 1 Stand in front of the pedelec. Clamp the front wheel between your legs. Grasp the handlebar grips.
- 2 Try to twist the handlebars against the direction of the front wheel.
⇒ The stem must not move or twist.
- 3 If the stem can be twisted, check fastening.
⇒ If the stem cannot be fastened, contact your specialist dealer.

5.3.8.2 Checking stem is firmly in position

- 1 Press full body weight on the handlebars.
⇒ The handlebars must not move downwards in the fork.

Stem with clamping lever version I

- 2 If the handlebars should move, increase the lever tension in the clamping lever.
- 3 Turn knurled nut in a clockwise direction with the clamping lever open.
- 4 Close clamping lever and check stem is firmly in position again.
- 5 If the handlebars cannot be fastened, contact your specialist dealer.

Stem with clamping lever version II and stem with screw

- ▶ If the handlebars cannot be fastened, contact your specialist dealer.

5.3.8.3 Checking the bearing clearance

- 1 Place the fingers of one hand on the upper headset cup. Pull the front wheel brake with the other hand and try to push the pedelec backwards and forwards.
Keep in mind that there may be noticeable backlash due to worn-out bearing bushes or brake lining backlash in suspension forks and disc brakes.
⇒ The headset cup halves must not move towards one another.
- 2 Adjust bearing clearance as per the stem repair manual as quickly as possible; otherwise, the bearing will become damaged. Contact specialist dealer.

5.4 Selling the pedelec

- ▶ Complete pedelec pass on the operating instructions envelope.
- ▶ Note down the manufacturer and the number of the battery key.
- ▶ Adjust the pedelec; see Section 6.5.
- ▶ Adjust the stand and shifter.
- ▶ Brief pedelec rider on all the pedelec's functions (see Section 6.3).

6 Operation

6.1 Risks and hazards

WARNING

Injuries and death caused by blind spots

Other road users, trucks, cars and pedestrians often underestimate the speed of pedelecs. Likewise, other road users frequently do not see pedelecs. This may lead to an accident with serious injuries or even death.

- ▶ Wear a helmet. The helmet must have a reflective strip or a light in a clearly visible colour.
- ▶ Clothing should be retroreflective or as light as possible. Fluorescent materials are also suitable. High-visibility jackets and straps on your upper body ensure even greater safety.
- ▶ Always take a defensive approach to riding.
- ▶ Avoid the blind spots of vehicles turning off the road. Reduce speed as a precaution when other road users turn right.

Injuries and death caused by riding incorrectly

A pedelec is not a bicycle. Mistakes made while riding and underestimated speeds quickly lead to hazardous situations. This can cause an accident with serious or fatal injuries.

- ▶ Slowly get used to road traffic and speed before riding at speeds over 12 km/h, especially if you have not ridden a bike for some time.
- ▶ Increase the levels of assistance gradually.
- ▶ Practice braking hard on a regular basis.
- ▶ Take and complete a riding safety course.

WARNING

Injuries and death caused by distraction

A lack of concentration while riding increases the risk of an accident. This may cause a crash with serious injuries.

- ▶ Never allow yourself to be distracted by the on-board computer or your mobile phone.
- ▶ Stop the pedelec if you want to make inputs on the on-board computer other than change the level of assistance. Only enter data when stationary.

CAUTION

Crash caused by loose clothing

Laces, scarves and other loose items may become entangled in the spokes on the wheels and the chain drive. This may cause a crash with injuries.

- ▶ Wear sturdy footwear and close-fitting clothing.

Crash caused by difficult-to-spot damage

If the pedelec topples over or you have a fall or an accident, there may be difficult-to-spot damage to components such as the brake system, quick releases or frame. This may cause a crash with injuries.

- ▶ Take pedelec out of service. Contact specialist dealer.

**CAUTION****Crash caused by material fatigue**

Intensive use can cause material fatigue. A component may suddenly fail in case of material fatigue. This may cause a crash with injuries.

- ▶ Remove the pedelec from service immediately if there are any signs of material fatigue. Have your specialist dealer inspect the component.
- ▶ Arrange the mandatory inspection appointments with your specialist dealer on a regular basis. During the major inspection, the specialist dealer will inspect the pedelec for any signs of material fatigue on the frame, fork, suspension element mountings (if there are any) and components made of composite materials.

Carbon becomes brittle when exposed to heat radiation such as heating. This can cause the carbon part to break and result in a crash with injuries.

- ▶ Never expose carbon components parts on the pedelec to strong sources of heat.

Crash caused by poor road conditions

Loose objects, such as branches and twigs, may become caught in the wheels and cause a crash with injuries.

- ▶ Be aware of the road conditions.
- ▶ Ride slowly and brake in good time.

The *tyres* may slip on wet roads. In wet conditions you must also expect a longer braking distance. The braking sensation differs from the usual sensation. This can cause loss of control or a crash, which may result in injuries.

- ▶ Ride slowly and brake in good time when it is raining.

**CAUTION****Crash caused by soiling**

Heavy soiling can impair pedelec functions, such as braking. This may cause a crash with injuries.

- ▶ Remove coarse soiling before riding.

Notice

Heat or direct sunlight can cause the *tyre pressure* to increase above the permitted maximum pressure. This can destroy the *tyres*.

- ▶ Park pedelec in the shade.
- ▶ On hot days, regularly check the *tyre pressure* and adjust it as necessary.

When riding downhill, high speeds may be reached. The pedelec is only designed to exceed a speed of 25 km/h for short intervals. The *tyres* in particular can fail if exposed to a continuous load.

- ▶ Use the brakes to decelerate the pedelec if you reach speeds greater than 25 km/h.

Moisture penetrating at low temperatures may impair individual functions due to the open structural design.

- ▶ Always keep the pedelec dry and free from frost.
- ▶ If the pedelec is used at temperatures below 3 °C, the specialist dealer must perform a major inspection beforehand and prepare it for winter use.

Off-road riding subjects the joints in the arms to severe strain. Take a break from riding every 30 to 90 minutes, depending on the road surface conditions and your physical fitness.

6.2 Tips for a greater range

The pedelec's range depends on many influencing factors. A single battery charge may only last fewer than 20 kilometres but much more than 100 is also possible. Test the pedelec's range before embarking on longer rides. There are a few tips which will generally help you maximize range.

Suspension elements

- ▶ Only open suspension fork and damper when necessary on terrain or gravel paths. Block suspension fork and damper on tarmacked roads or on hills.

Mileage

The more own physical effort the rider makes, the greater the attainable range is.

- ▶ Shift down 1 to 2 gears to increase the induced power and pedalling frequency.

Pedalling frequency

- ▶ Ride using pedalling frequencies of over 50 revolutions per minute. This optimises the electric drive's efficiency.
- ▶ Avoid pedalling very slowly.

Weight

- ▶ Minimise the total weight of pedelec and baggage.

Stopping and starting

- ▶ Ride long distances at a constant speed.
- ▶ Avoid stopping and starting frequently.

Level of assistance

- ▶ The lower the selected levels of assistance are, the greater the range is.

Gear switching habits

- ▶ Use a low gear and a low level of assistance on hills and when setting off.
- ▶ Switch up a gear depending on the speed and terrain.
- ▶ 50-80 crank rotations per minute are optimal.
- ▶ Avoid high stress loads on the crank during a gear change.
- ▶ Switch gear back in good time, e.g. before inclines.

Tyres

- ▶ Always select the right tyres for the surface type. As a general rule, narrower treads move along more easily than heavier ones. Long studs and large grooves usually have an unfavourable effect on energy consumption.
- ▶ When riding on asphalt, it is important to always use the maximum permitted tyre pressure.
- ▶ When riding off-road, on gravel tracks or soft woodland or meadow soils, it is important to remember: the lower the tyre pressure is, the greater the rolling resistance is and thus the greater electric drive system energy consumption is.

Rechargeable battery

Electrical resistance increases as the temperature drops. Battery performance is reduced. As a result, you should expect the range to be shorter than normal in winter.

- ▶ Use a thermal protection sleeve on the battery in winter.

The range also depends on the battery's age, charge level and state of repair.

- ▶ Maintain the battery and replace older batteries where necessary.

6.3 Error message

6.3.1 On-board computer

The on-board computer indicates whether a critical or less critical error has arisen in the drive system.

The error messages generated by the drive system can be read in the eBike Flow app and by the specialist dealer.

The rider can use a link in the eBike Flow app to display all information on errors and assistance on eliminating errors.

6.3.1.1 Less critical errors

The indicator for the selected level of assistance will flash orange in the event of less critical errors.

▶ Press selection button.

⇒ The error is acknowledged and the indicator for the selected level of assistance displays the colour for the configured level of assistance permanently.

You can eliminate errors yourself using the following table when necessary. Contact your specialist dealer if the problem persists.

Code	Description	Method of resolution
0x523005 0x514001 0x514002 0x514003 0x514006	The sensors do not detect the magnetic field properly.	<ul style="list-style-type: none"> ▶ Check that the magnet wasn't lost while riding. ▶ If a magnet sensor is used, check that the sensor and magnet have been fitted properly. In doing so, ensure that the cable to the sensor is not damaged. ▶ If a rim magnet is used, ensure that there is no magnetic field interference near the drive unit.

Table 49: List of on-board computer error messages

6.3.1.2 Critical errors

The indicator for the selected level of assistance and battery level indicator flash red to indicate critical errors.

▶ Contact specialist dealer.

▶ Never connect a charger.

6.3.2 Rechargeable battery

The battery is protected against deep discharge, overcharging, overheating and short circuits by Electronic Cell Protection (ECP). In the event of a hazard, a protective circuit switches the battery off automatically. If a fault is detected in the battery, the LEDs flash on the battery level indicator.



Description	Method of resolution
<p>Code:</p> 	
<p>If the battery is outside its charging temperature range, three LEDs will flash on the battery level indicator.</p>	<ol style="list-style-type: none"> 1 Disconnect charger from battery. 2 Leave battery to cool down or warm up. 3 Contact your specialist dealer if the problem persists.
<p>Code:</p> 	
<p>If a fault is detected in the battery, two LEDs flash on the battery level indicator.</p>	<p>▶ Contact specialist dealer.</p>
<p>Code:</p> 	
<p>No LEDs will light up if there is no power.</p>	<ol style="list-style-type: none"> 1 Check all plug connections. 2 Check contacts on the battery for dirt. Clean the contacts carefully if needed. 3 Contact your specialist dealer if the problem persists.

Table 50: List of battery error messages

6.4 Instruction and customer service

The supplying specialist dealer will provide customer service. Contact details can be found on the pedecec pass for these operating instructions. The specialist dealer will explain all the pedecec functions to the new owner in person, this being when the specialist dealer hands over the pedecec at the latest. These operating instructions are provided with every pedecec, so that the rider can consult them at a later stage.

The supplying specialist dealer will also perform all inspection, modifications and repairs in the future.

6.5 Adjusting the pedecec



Crash caused by incorrectly adjusted torque

If a screw is fastened too tightly, it may break. If a screw is not fastened enough, it may loosen. This will cause a crash with injuries.

- Always observe the torque indicated on the screw and in the operating instructions.

Only a correctly adjusted pedecec will guarantee the desired ride comfort and health-promoting activity.

All settings must be re-configured if the body weight or maximum baggage weight changes.

6.5.1 Preparing

The following tools are required to adjust the pedecec:









	Tape measure
	Scales
	Spirit level
	Ring spanners 8 mm, 9 mm, 10 mm, 13 mm, 14 mm und 15 mm
	Torque wrench Working range 5... 40 Nm
	Hex key 2 mm, 2.5 mm, 3 mm, 4 mm, 5 mm, 6 mm and 8 mm
	Cross-recess screwdriver
	Slotted-head screwdriver

Table 51: Tools required for assembly

6.5.2 Determining the sitting position

The starting point for a comfortable posture is the correct position of the pelvis. If the pelvis is in the wrong position, it can cause different types of pain, e.g. in the shoulder or back.

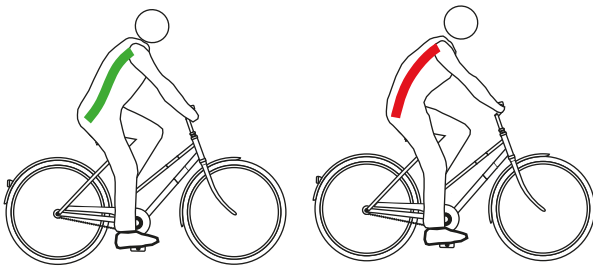

Figure 100: The pelvis is in the right position (green) or incorrect position (red)

The pelvis is in the right position if the spine forms an S-shape and a natural, easy arch.

The pelvis is positioned incorrectly if it tilts slightly backwards. As a result, the spine becomes curved and can no longer deflect to an optimal extent.

A suitable sitting position must be selected beforehand depending on the pedelec type, physical fitness and desired trip distance or speed.

It is especially advisable to check and optimise the sitting position once more before longer rides.

Position on roadster	Position on city bike
Angle of upper body (black dashed line)	
Upright, almost vertical posture, back at an angle of almost 90°. Handlebars and handles are very close to the upper body.	Slightly inclined upper body, back at an angle of 60°...70°.
Upper arm-upper body angle (red line)	
Extremely acute angle at around 20°. The upper arms are almost parallel to the upper body. The hands are simply placed loosely on the handlebars	An angle of 75°–80° is optimum. Many people prefer a smaller angle of up to 60° as it requires less effort to support the shoulders, arms and hands.
Saddle-handlebar height difference [cm] (blue and green line)	
>10 The handlebars are positioned far higher than the saddle.	10 to 5 The handlebars are positioned higher than the saddle.
Benefits	
The spine is intuitively moved into its natural S-shape. The strain on arms and hands is very slight – no effort required to support.	The upright position provides a good overview in traffic. Force can be applied to the pedals when pedalling without using much energy.
Disadvantages	
Force is applied relatively inefficiently to the pedals. Weight rests exclusively on the buttocks. The spine slumps after a short time for many people (pelvic straightening).	The arms are often stretched through to the high handlebars – this leads to tense shoulders and painful hands. The spine tends to slump quickly due to the “high position”.
Fitness level and use	
Low fitness level, occasional cyclists.	Medium fitness level, city cyclists.

Table 52: Overview of sitting positions

6.5.3 Seat post

6.5.3.1 Adjusting the seat post to body weight

Not included in price



Seat posts are components that may be replaced after approval by the vehicle or parts manufacturer. Only seat posts that are approved for use on e-bikes may be used to replace existing ones.

Replacing with different sizes and hardnesses within a product series is permitted for seat posts. Moreover, seat posts may be exchanged if the rearward offset for the series or original range of use is not greater than 20 mm. This is because a change in load distribution outside the intended adjustment range can lead to hazardous steering performance. The seat post length must always be the same when replacing posts.

The correct functioning of the following seat posts depends on the body weight:

- Suspension seat post
- Rhomboid seat post
- Lowerable seat post

If the body weight falls below or exceeds the specifications in Section 3.5.10, either the seat post spring or, in the case of integrated seat posts, the complete seat post must be replaced with a seat post from the same product series that is appropriate for the body weight.

The preload in non-damped suspension seat posts must be adjusted in such a way that the suspension seat post does not deflect with just body weight. This prevents the suspension seat post from deflecting and bobbing intermittently at higher pedalling frequencies or if the rider pedals irregularly.

The spring stiffness can be set lower with damped suspension seat posts, thus making use of the negative deflection.

6.5.4 Saddle



CAUTION

Sitting discomfort due to wrong saddle

Around 50% of all pedelec riders experience discomfort due to incorrect sitting.

- ▶ Adjust the saddle (see Section 6.5.5).
- ▶ Check settings.
- ▶ If the saddle does not fit or causes pain, replace existing saddle with a large one which matches the sit bone distance.

6.5.4.1 Replacing the saddle

Not included in price



Saddles are components that may be replaced after approval by the vehicle or parts manufacturer. Replacing different sizes within a product series is permitted for saddles. Moreover, saddles may be exchanged if the rearward offset to the series or original range of use is not greater than 20 mm since a change in load distribution outside the intended adjustment range can lead to critical steering performance. The saddle shape plays a role here. Only saddles that are approved for use on e-bikes may be used to replace the existing ones.

If the pre-mounted saddle is uncomfortable or causes pain, a saddle optimised to the rider's physique must be used. To do so:

- Determine the saddle shape (see Section 6.5.4.1)
- Establish the saddle width (see Section 6.5.4.2 or 6.5.4.3)
- Select the saddle hardness (see Section 6.5.4.5)
- Check the saddle.

6.5.4.2 Determining saddle shape

Ladies' saddle

To distribute the pressure optimally over the female bone structure in the seat area, a ladies' saddle should:

- have a relief opening far to the front
- have a wide, V- shaped saddle edge.



Figure 101: Example: Ergotec ladies' saddle

Men's saddle

Numbness when pedalling is often caused by high pressure in the sensitive perineal area. If the saddle is adjusted incorrectly, too narrow or too hard, the nose of the saddle presses directly onto the genitals. Blood circulation deteriorates.

The genitals on the outside are seldom the cause of discomfort since they can move out of the way and are not compressed by bone structures.

You should always consult a doctor if you have problems with your prostate. After a prostate operation or inflammation, it is advisable to avoid any pressure in the perineal area and take a longer break from pedelec riding after consulting your doctor. A prostate saddle should then be used. This reduces the pressure in the perineal area by up to 100%.

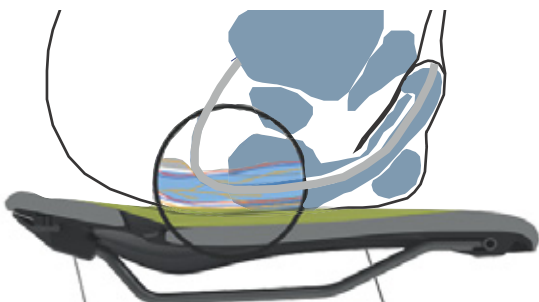

Figure 102: Pressure points on a saddle, male anatomy

To distribute the pressure on the male bone structure in the seat area optimally, the saddle should:

- Shift the pressure to the sitting bones and parts of the pubic arches
- The perineal area must remain as free of pressure as possible



Figure 103: Example: Ergotec men's saddle

6.5.4.3 Determining minimum saddle width with corrugated cardboard

- 1 Place corrugated cardboard on a flat, hard, unpadded seat.
- 2 Sit in the middle of the corrugated board.

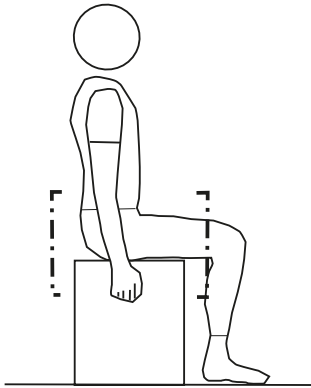

Figure 104: Sitting on the corrugated board

- 3 Pull the seat with your hands and arch your back.
 - ⇒ The sitting bones are more prominent and stand out more clearly on the corrugated cardboard.
- 4 Trace the outer edges of the two depressed areas in a circle.
- 5 Determine the centre of both circles and mark them with a dot.
- 6 Measure the distance between the two centres.

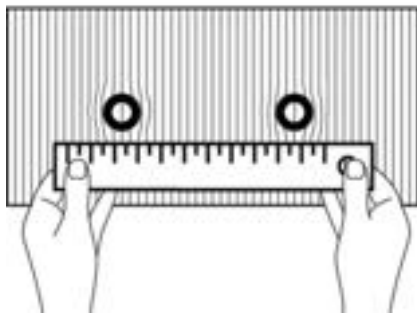

Figure 105: Measuring the distance

- ⇒ The distance between the two centre points is the sit bone distance and corresponds to the minimum saddle width.
- 7 Calculate saddle width (see Section 6.5.4.4).



6.5.4.4 Determining minimum saddle width with gel cushion

- 1 Smooth gel cushion.
- 2 Place gel cushion on a flat, hard, unpadded seat.
- 3 Sit in the middle of the gel cushion.

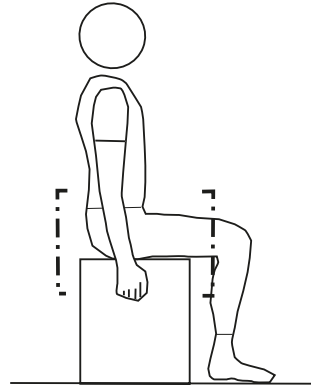

Figure 106: Sitting on the gel cushion

- Pull the seat with your hands and arch your back.
- 4 The sitting bones are more prominent and stand out more clearly on the gel cushion.

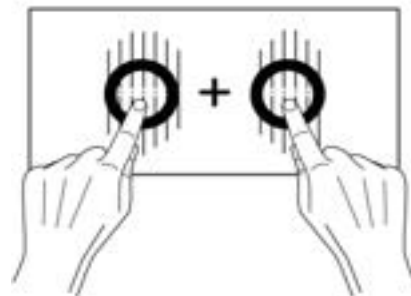

Figure 107: Adding the centres together

- 5 Determine the centres of both sitting bones.
- 6 Add the two values together.
 - ⇒ The total of the values is the sitting bone distance and corresponds to the minimum saddle width.
- 7 Calculate saddle width (see Section 6.5.4.4).

6.5.4.5 Calculating the saddle width

Depending on the position, the following value is added to the minimum saddle width.

Position on roadster	+ 4 cm
Position on city bike	+ 3 cm
Position on trekking bike	+ 2 cm
Position on sports bike	+ 1 cm
Triathlon/time trials	+ 0 cm

Table 53: Calculating the saddle width

6.5.4.6 Selecting the saddle hardness

Saddles are available in a wide range of hardnesses and must be adapted to the pedelec's use:

- A pedelec that is mainly used for commuting in jeans calls for a soft saddle.
- A pedelec that is mainly used for sports riding with padded cycling shorts requires a hard saddle.

If the degree of hardness is not suitable, a new saddle must be selected.

6.5.4.7 Adjusting the saddle hardness

Only applies to pedelecs with this equipment

In air cushion saddles, the hardness of the saddle can be adjusted using the pump valve beneath the seat surface.

Soft	Pump 3 times
Medium	Pump 5 times
Hard	Pump 10 times

Table 54: VELO air cushion saddle settings

6.5.4.8 Straighten saddle

- ▶ Position saddle in direction of travel. In doing so, align the tip of the saddle with the top tube.

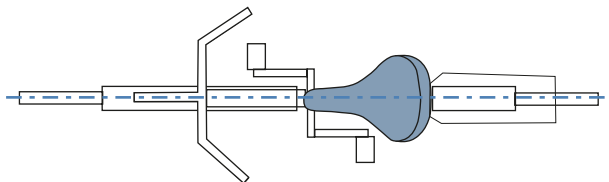

Figure 108: Positioning the saddle in direction of travel

6.5.4.9 Adjusting the saddle height

- ✓ To adjust the saddle height safely, either:
 - Push the pedelec near to a wall so that the pedelec rider can lean on the wall to support themselves or
 - Ask another person to hold the pedelec.
- 1 Use the seat height formula to roughly set the saddle height:

$$\text{Seat height (SH)} = \text{inner leg length (I)} \times 0.9$$
 - 2 Climb onto the bicycle.
 - 3 Place your heel on the pedal and extend your leg, so that the pedal is at the lowest crank rotation point. Your knee should now be fully extended.

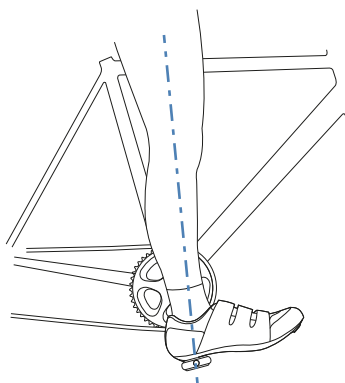

Figure 109: Heel method

- 4 Take a test ride.

- ⇒ Pedelec riders sit straight on the saddle at an optimal saddle height.
 - If the pelvis moves to the left and right as you pedal, the saddle is too high.
 - If your knees are painful after a few kilometres, the saddle is too low.
- ⇒ Position the seat post according to needs if necessary. Adjust the seat height with the quick release.

- 5 Open the quick release on the seat post to change the seat height (1). To do so, push the clamping lever away from the seat post (3).

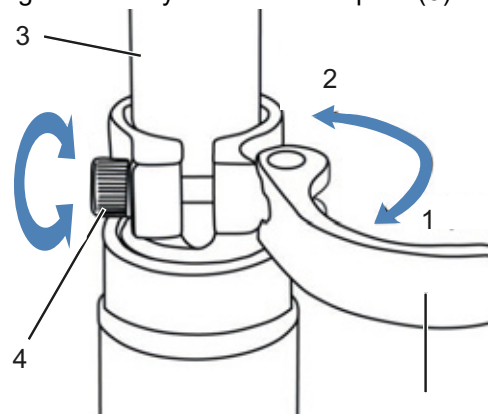

Figure 110: Opening the seat post quick release

- 6 Set the seat post to the required height.

⚠ CAUTION

Crash caused by an excessively high seat post setting

A *seat post* which is set too high will cause the *seat post* or the *frame* to break. This will cause a crash with injuries.

- ▶ Do not pull the seat post out of the frame beyond the minimum insertion depth marking.

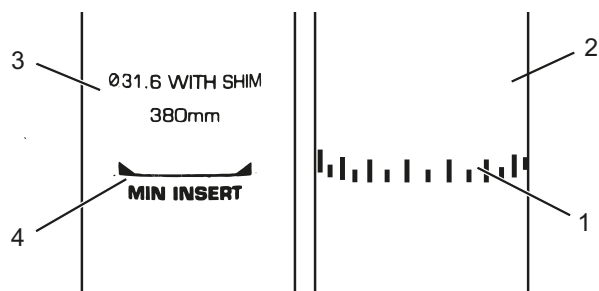

Figure 111: Detailed view of the seat post – examples of the minimum insertion depth marking

- 7 To close it, push the *seat post clamping lever* as far as it will go into the *seat post* (2).
- 8 Check the *clamping force of the quick releases*.

6.5.4.10 Setting the saddle height with the remote control

Use the seat height formula to set the saddle height:

$$\text{Seat height (SH)} = \text{inner leg length (I)} \times 0.9$$

Notice

If you are unable to achieve the required saddle height, the seat post must be lowered further into the seat tube. The seat post Bowden cable must be tightened in the frame up to the remote control to the same length as the seat post was lowered. If this is not possible, contact your specialist dealer.

Lowering the saddle

- 1 Sit on the saddle.
- 2 Press the remote control operating lever.
- ⇒ The seat post will lower.
- 3 Release the remote control operating lever when you have reached the desired height.

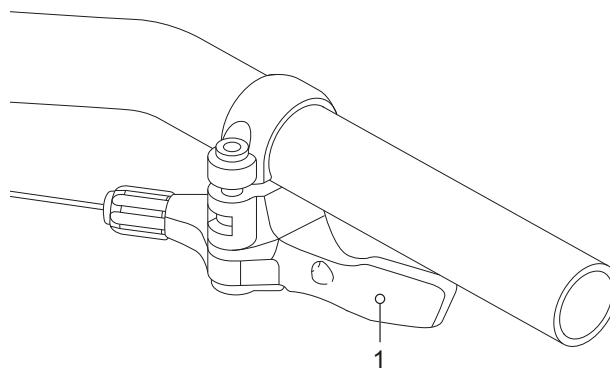

Figure 112: Remote control operating lever (1)

Raising the saddle

- 1 Remove any pressure from the saddle.
- 2 Press the remote control operating lever.
- ⇒ The seat post will rise.
- 3 Release the remote control operating lever when you have reached the desired height.

6.5.4.11 Adjusting the saddle position

The saddle can be shifted on the saddle frame. The right horizontal position ensures an optimal leverage position for legs. This prevents knee pain and painful incorrect pelvis positions. If you have displaced the saddle more than 10 mm, you need to adjust the saddle height again since both settings affect one another.

- ✓ The saddle setting must only be made when the bicycle is stationary.
 - ✓ To set the saddle position, either:
 - Push the pedelec near to a wall so that the pedelec rider can lean on the wall to support themselves or
 - Ask another person to hold the pedelec.
 - ✓ Move the saddle within its permitted displacement range only (marked on the saddle stay).
- 1 Climb onto the pedelec.
 - 2 Place the pedals into the vertical position with your feet.
 - ⇒ Pedelec riders are adopting the optimal saddle position if the perpendicular line from the kneecap runs through the pedal axle.
 - ▶ If the perpendicular line crosses behind the pedal, bring the saddle further forward.
 - ▶ If the perpendicular line crosses in front of the pedal, bring the saddle further back.

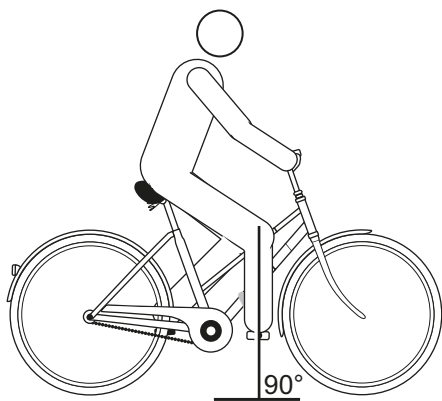

Figure 113: Knee cap perpendicular line

- 3 Unfasten and adjust the designated screw connections, and clamp them with the maximum tightening torque for the saddle clamping screws.

6.5.4.12 Adjusting the saddle tilt

The saddle tilt must be adjusted to the seat height, the saddle and handlebar position, and the saddle shape to ensure an optimum fit. The seating position can be optimised in this way if needed.

The saddle prevents pedelec riders from slipping backwards or forwards when placed in a horizontal position. This prevents seat problems. In any other position, the tip of the saddle may press uncomfortably into the crotch area. It is also recommended that the centre of the saddle is exactly straight. This ensures that the rider is seated with their sit bones on the wide rear part of the saddle.

- 1 Adjust the saddle tilt to horizontal.
- 2 Position saddle middle so that it is completely

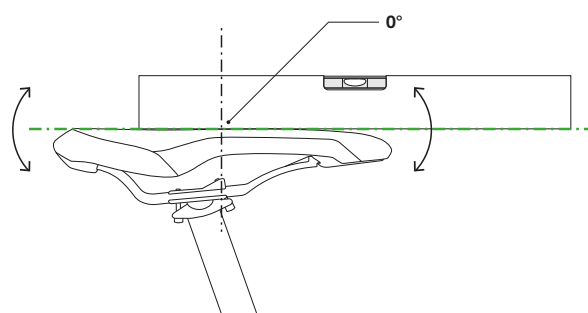

straight.

Figure 114: Horizontal saddle tilt with 0° tilt in the centre of the saddle

- ⇒ Pedelec riders sit comfortably on the saddle and do not slip backwards or forwards.
- 3 Pedelec riders tend to slip forwards on the narrow part of the saddle, adjust the riding position (see Section 6.6.2.3) or tilt the saddle very slightly backwards.

6.5.4.13 Checking saddle stability

- ▶ Check saddle stability after adjusting it (see Section [7.5.13](#)).

6.5.5 Handlebars

6.5.5.1 Replace handlebars

Not included in price



Handlebars are components that may be replaced after approval by the vehicle or parts manufacturer. Only handlebars that are approved for use on e-bikes may be used to replace the existing ones. Handlebars may be replaced if the cable and/or line lengths do not need to be changed. A change in riding position is allowed within the original cable length. Furthermore, the load distribution on the pedelec changes considerably and may potentially lead to critical steering performance

- ▶ Check handlebar width and hand position.
- ▶ Have handlebars replaced at the specialist dealer's if necessary.

6.5.5.2 Adjusting the handlebar width

The handlebar width should be as wide as the rider's shoulders as a minimum. This is measured from mid-point to mid-point on the hand contact surfaces.

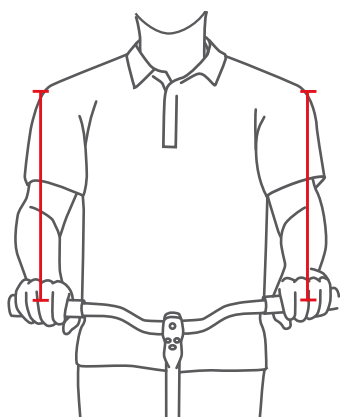

Figure 115: Determining the optimal handlebar width

The wider the handlebars are, the more control they provide, although wide handlebars require greater supporting force. Wider handlebars are particularly useful to ensure a safer ride for loaded touring bikes.

6.5.5.3 Adjusting the hand position

The hand is in an optimal position on the handlebars when the forearm and hand are in a straight line, i.e. the wrist is not bent. In this way, the nerves are not pinched and do not cause pain.

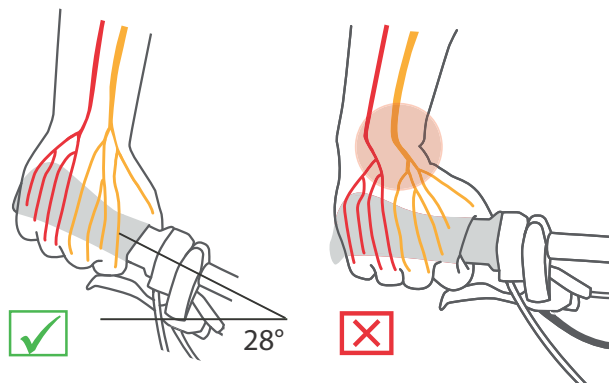

Figure 116: Distribution of nerves with curved and straight handlebars

The narrower the shoulders are, the greater the bend of the handlebars should be (maximum 28°).

Straight handlebars are advisable for sports bikes (e.g. MTB). They support direct steering behaviour, but lead to peaks in pressure and greater muscular strain on the arm and shoulder muscles.

6.5.5.4 Adjusting the handlebars

The handlebars and their position determine the posture that the pedelec rider adopts on the pedelec.

- 1 After selecting the riding position (see Section 6.6.2.1), determine the angle of the upper body and upper arm.
- 2 Pre-tension the back muscles when adjusting the handlebars. The only way to stabilise the spine and protect it from excessive strain is with the back and abdominal muscles pre-tensioned. Passive muscles are not able to perform this important task.
- 3 Set the required handlebar position by adjusting the stem height and angle (see Section 6.6.6).
- 4 After adjusting the handlebars, check the saddle height and riding position again. The position of the pelvis on the saddle may have changed when the handlebars were adjusted. This can have considerable impact on the position of the hip joint due to the pelvis tilting and may change the usable leg length on the saddle support by up to 3 cm.
- 5 Correct the saddle height and riding position if necessary.

6.5.6 Stem

6.5.6.1 Replacing the handlebars

Not included in price



Handlebar-stem units are components that may be replaced after approval by the vehicle or parts manufacturer.

Only units that are approved for use on e-bikes may be used to replace the existing ones. A stem must be replaced if cable and/or line lengths do not need to be changed.

A change in riding position is allowed within the original cable length. Furthermore, the load distribution on the pedelec changes considerably and may potentially lead to hazardous steering performance.

6.5.6.2 Adjusting the handlebar height with quick release

Only applies to pedelecs with this equipment

- 1 Open the stem clamping lever.

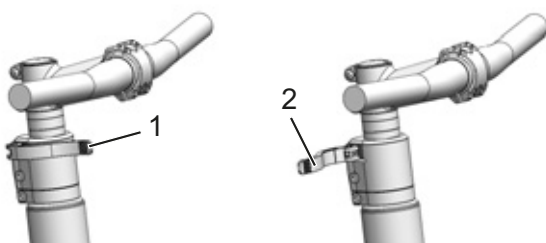

Figure 117: Open (2) and closed (1) stem clamping lever; All Up used as an example

- 2 Pull out the handlebars to the required height. Observe minimum insertion depth.

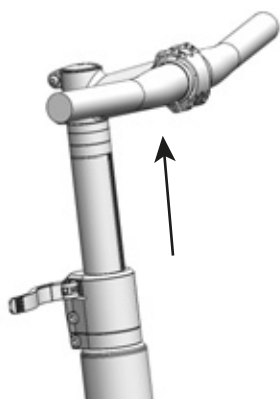

Figure 118: Pulling the handlebars upwards; All Up used as an example

- 3 Close the stem clamping lever.

6.5.6.3 Checking the stem stability

- ▶ Hold handlebars firmly after adjusting the saddle. Press full body weight on the handlebars.
- ⇒ The handlebars remain stable in their position.

6.5.6.4 Adjusting the quick release clamping force



Crash caused by incorrectly set clamping force

Applying excessive clamping force damages the quick release. Insufficient clamping force will result in unfavourable transmission of force. This can cause components to break. This will cause a crash with injuries.

- ▶ Never fasten a quick release using a tool (e.g. hammer or pliers).

If the *handlebar clamping lever* stops before reaching its end position, unscrew the *knurled nut*.

- ▶ Tighten the *knurled nut* on the seat post if the *seat post clamping lever's* clamping force is not effective enough.
- ▶ Contact your specialist dealer if the clamping force cannot be set.

6.5.6.5 Setting the quill stem

Only applies to pedelecs with this equipment

In the case of a quill stem, the stem and fork steerer form a permanently interconnected component, which is clamped in the fork steerer. The stem and shaft must be replaced together.

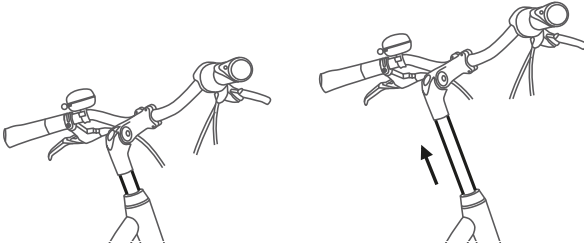

Figure 119: Adjusting the quill stem height

- 1 Undo screw.
- 2 Pull quill stem out.
- 3 Tighten screw.

6.5.6.6 Adjusting the Ahead stem

Only applies to pedelecs with this equipment

In the case of an Ahead stem, the stem is placed directly on the fork steerer, which protrudes over the frame.

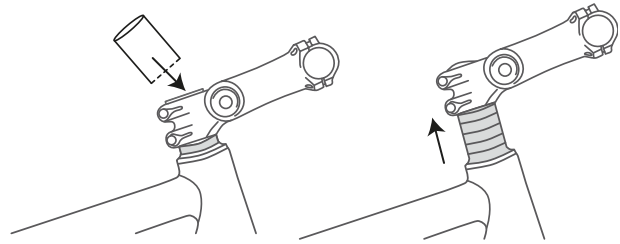

Figure 120: Raising the Ahead stem by fitting spacer rings

The handlebar height is adjusted once during production using spacer rings. The part of the fork steerer protruding is then cut off. The handlebar stem can then no longer be set higher, but only slightly lower.

6.5.6.7 Adjusting the angle-adjustable stem

Only applies to pedelecs with this equipment

Angle-adjustable stems are available in different lengths for quill and Ahead stems.

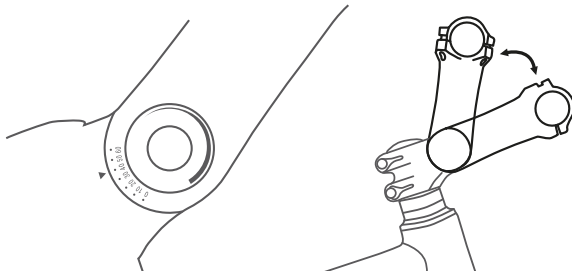

Figure 121: Different versions of angle-adjustable stems

Adjusting the stem angle (c) changes both the distance from the upper body to the handlebars (b) and the handlebar height (a).



Figure 122: City bike (blue) and trekking bike position (red) by changing the angle

6.5.7 Handles

6.5.7.1 Replacing the handles

Not included in price



Handles with bolt clamps are components which may be replaced without approval. Only handles that are approved for use on e-bikes may be used to replace the existing ones.

If there is pain or numbness in the index, middle finger or thumb, this may be due to excessive pressure on the exit of the carpal tunnel. On longer rides, this can increasingly cause hand fatigue and make it more and more difficult to maintain a correct hand position.

In the case of ergonomically shaped handles, the palm rests on the anatomically shaped handle. A greater contact surface means that the pressure is more evenly distributed. Nerves and vessels are no longer squeezed in the carpal tunnel.

Moreover, the hand is supported and held in the correct position so that the hand can no longer bend.

If the pre-mounted handles are uncomfortable or cause pain or numbness in the index, middle finger or thumb, ergonomic handles, bar ends or multi-position handlebars should be used.

6.5.7.2 Adjusting ergonomic handles

Only applies to pedelecs with this equipment

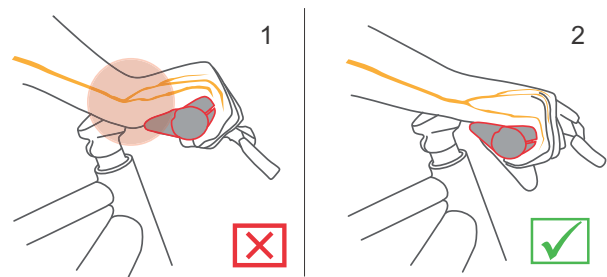

Figure 123: Incorrect (1) and correct (2) position of the handle



- 1 Undo handle clamping screw.
 - 2 Turn handle into the right position.
 - 3 Fasten handle clamping screw with the torque value indicated there.
- ⇒ The handles are firmly fastened.
- ⇒ The pull-off force of the handles is at least 100 N in the roadster, city and trekking positions, and at least 200 N in the sporty position.

6.5.7.3 Checking handlebar stability

- See Section [7.5.12](#).

6.5.8 Tyres

6.5.8.1 Replacing tyres

Not included in price



Different tyres need to be used when the area of use is changed, more weight or greater puncture protection is added, and greater acceleration or more dynamic cornering is used.

Tyres may only be replaced after approval by the vehicle or parts manufacturer.

Tyres may be replaced if

- They are approved for use on e-bikes
- They comply with ETRTO dimensions
- They have the same load capacity as a minimum
- They have a comparable level of puncture protection as a minimum

6.5.8.2 Adjust tyre pressure

The correct tyre pressure largely depends on the weight load on the tyres. This load is determined by the pedelec's tare weight, the rider's body weight and the luggage load.

Unlike cars, the weight of the vehicle has little impact on the total weight. Moreover, the personal preferences for low rolling resistance or a high degree of suspension comfort vary a great deal.

It is important to remember that

- the higher the tyre pressure is, the lower the wear, rolling resistance and the risk of breakdown are.
- The lower the pressure in the tyre is, the greater the comfort and grip that the tyre offers is.

In the case of pedelecs used on the road, the rule is the greater the tyre pressure is, the lower the tyre rolling resistance is. The risk of breakdown is also lower when the pressure is high. A permanently excessively low tyre pressure often leads to premature wear in the tyre. Cracking in the side wall is a typical consequence of very low tyre pressure. Abrasion is also unnecessarily high.

On the other hand, a tyre can absorb road impacts more effectively at a low pressure.

As a general rule, wide tyres are operated at a lower tyre pressure. They provide the option of exploiting the advantages of the lower tyre pressure without the serious disadvantages it causes with regard to wear, rolling resistance and breakdown protection.

- ✓ Never exceed or go below the minimum and maximum pressure limits indicated on the tyre.

1 Pump the tyre to the recommend tyre pressure.

Tyre width	Tyre pressure in bar for body weight		
	approx. 60 kg	approx. 80 kg	approx. 110 kg
25 mm	6.0	7.0	8.0
28 mm	5.5	6.5	7.5
32 mm	4.5	5.5	6.5
37 mm	4.0	5.0	6.0
40 mm	3.5	4.5	6.0
47 mm	3.0	4.0	5.0
50 mm	2.5	4.0	5.0
55 mm	2.0	3.0	4.0
60 mm	2.0	3.0	4.0

Table 55: SCHWALBE recommend tyre pressure

2 Perform a visual check on tyres.



Figure 124: Correct tyre pressure. The tyre is barely deformed under the load of the body weight



Figure 125: Far too little tyre pressure

6.5.9 Brake

The handbrake grip distance can be adjusted to ensure that it can be reached more easily. The pressure point can also be adjusted to the pedelec rider's preferences.

6.5.9.1 Replacing brakes

Not included in price



The braking system components may only be replaced with original components.

In the case of disc brake linings, the lining compound may be adapted to the surface and the rider's experience.

6.5.9.2 Retracting the brake linings

Disc brakes require wearing-in time. The braking force increases over time. The braking force is increased during break-in time. This is also the case when the brake pads or brake discs are replaced.

- 1 Accelerate pedelec to 25 km/h.
 - 2 Brake pedelec until it comes to a halt.
 - 3 Repeat process 30 to 50 times.
- ⇒ The disc brake is retracted and provides optimal braking power.

6.5.9.3 Change handbrake position

Having the handbrake in the correct position prevents the rider from stretching their wrist too far. Moreover, the brake can also be operated without any discomfort and without changing the handle position or releasing the handle.

- ✓ Apply handbrake with the third finger phalanx in bursts to brake gently.
 - ✓ The setting for the middle finger is used for pedelec riders who brake with their middle finger or with two fingers.
- 1 Position your hand on the handle in such a way that the outer heel of the hand is flush with the end of the handlebar.
 - 2 Extend the index finger (about 15°).

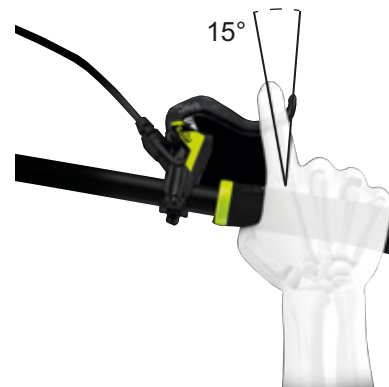

Figure 126: Handbrake position

- 3 Push handbrake outwards until the third finger phalanx sits in the recessed grip.

6.5.9.4 Change handbrake inclination angle

The nerves that pass through the carpal tunnel are connected to the thumb and the index and middle fingers. An excessively steep or excessively flat brake angle will cause the wrist to bend, thus narrowing the carpal tunnel. This can cause numbness and tingling in the thumb and index and middle fingers.

- 1 Calculate the difference between the height of the handlebars and the saddle height to determine the saddle-handlebar height difference.

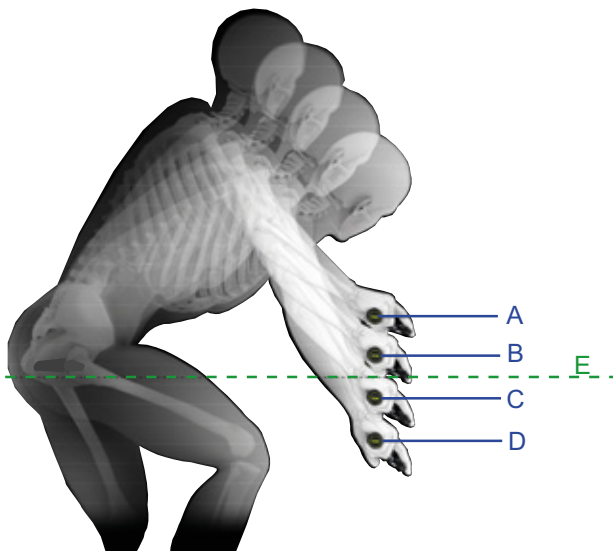

Figure 127: Example of 4 different handlebar heights (A, B, C and D) and the saddle height (E)

Calculation	Saddle-handlebar height difference [mm]
A – E	>10
B – E	0... +10
C – E	0... -10
D – E	< -10

Table 56: Examples of saddle-handlebar height difference

Adjust the angle of the handbrake so that it forms a natural extension of the forearm.

- 2 Set the brake lever angle as indicated in the table.

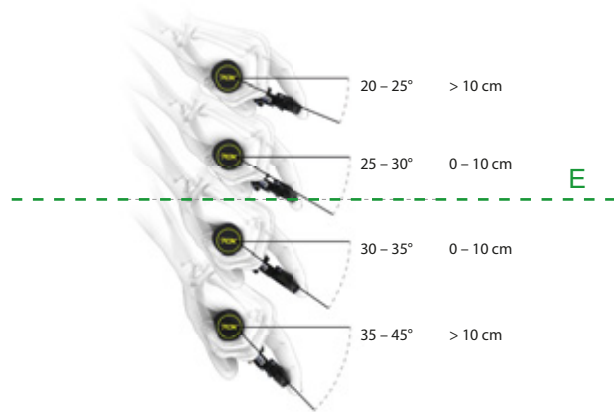

Saddle-handlebar height difference (mm)	Brake angle
>10	20°...25°
0... 10	25°...30°
0... -10	30°...35°
< -10	35°...45°

Figure 128: Brake angle

6.5.9.5 Determining the grip distance

- 1 Measure hand size using the grip distance gauge.
- 2 Adjust the grip distance at the pressure point based on the hand size.



Figure 129: Handbrake positioning

Hand size	Grip distance (cm)
S	2
M	3
L	4

6.5.9.6 Grip distance on a SHIMANO ST-EF41 handbrake

Only applies to pedelecs with handbrakes:

BL-M4100
BL-M7100
BL-M8100
BL-MT200
BL-MT201
BL-MT400
BL-MT401
BL-MT402
BL-T6000
GRX ST-RX600
M7100
M8100
RS785

The handbrake position can be adjusted to the pedelec riders' requirements.

► Contact specialist dealer.

6.5.10 Gear shift

Adjust the position of the gear shift to the pedelec riders' needs.

- 1 Undo attachment screw.
- 2 Place control panel or shifter into the position where the pedelec rider can use the control panel or the shifter with their thumb and/or index finger. The shifter must never block the handbrake.
- 3 Tighten attachment screw.



6.5.10.1 Replacing the gear shift

Not included in price

All gear shift components (rear derailleur, shifter, twist grip, shift cables and sleeves) may be replaced provided that:

- They are approved for use on e-bikes
- All gear shift components are suitable for the number of gears
- All gear shift components are compatible with one another

It is permitted to change from an electronic gear shift variant to a mechanical one.

It is prohibited to change from a mechanical gear shift variant to an electronic one.

6.5.10.2 Adjusting the SHIMANO shifter

Only applies to pedelecs with this equipment

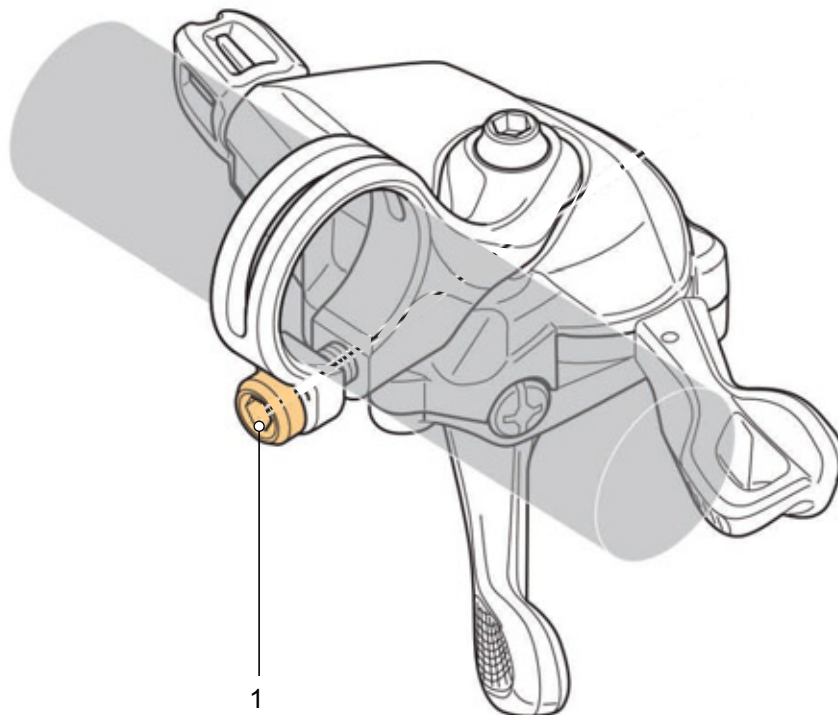

Figure 130: Position of attachment screw in SHIMANO shifter (1)

6.5.11 Suspension and damping

Suspension and damping can be adjusted to the rider's weight in up to six increments, depending on the suspension system.

► Follow the correct order for adjustment.

Sequence	Adjustment	Section	For pedelecs with components only	
			Suspension fork	Rear frame damper
1	Adjust the suspension fork sag	6.3.13	x	
2	Adjust the rear frame damper sag	6.3.14		x
3	Adjust the suspension fork rebound damper	6.3.15	x	
4	Adjust the rear frame damper rebound damper	6.3.16		x
5	Adjust the rear frame damper compression damper	6.3.17		x
6	The fork compression damper is adjusted to the terrain while riding.	06:11		x

Table 57: Correct order for suspension and damping adjustment

6.5.12 Adjusting sag (fork)



Crash caused by incorrectly set suspension

If the suspension is set incorrectly, the fork may become damaged, meaning problems may occur when steering. This will cause a crash with injuries.

- Never ride without air in air suspension forks.
- Never use the pedelec without adjusting the suspension fork to the body weight.

Adjustments on the chassis change ride performance significantly. The rider needs to get used to the pedelec and break it in to prevent accidents.

Sag (also referred to as negative deflection) is the percentage of the total deflection that is compressed by the rider's body weight, including equipment (such as a backpack), the seating position and frame geometry. Sag occurs whether you are actually riding or not.

The pedelec rebounds at a controlled speed if it is optimally adjusted. The wheel stays in contact with the ground when passing over bumps (blue line). The fork head, handlebars and body follow terrain (green line) when riding over bumps. The suspension motion is predictable and controlled.



Figure 131: Optimum fork ride performance

When optimally adjusted, the fork counteracts deflection on hilly terrain and stays higher in its deflection range.

This allows the rider to maintain the same speed more easily on hilly terrain.



Figure 132: Optimum fork ride performance on hilly terrain

When optimally adjusted, the fork deflects quickly and unhindered when the bike hits bumps and absorbs a bump. Traction is retained (blue line).

The fork responds quickly to the bump. The headset and handlebars rise slightly when absorbing a bump (green line).



Figure 133: Optimum fork ride performance over bumps

The sag depends on the position and body weight and should be set based on preferences and on how the pedelec is used.

Greater sag

A greater sag increases sensitivity to bumps, thus producing greater suspension motion. A greater sensitivity to bumps ensures more comfortable ride performance and is used on pedelecs with longer deflection.

Decreased sag

A decreased sag reduces sensitivity to bumps, thus producing less suspension motion. A lower sensitivity to bumps ensures a firmer, more efficient ride performance and is generally used on pedelecs with shorter deflections.

The adjustment shown here represents a default setting. The default settings should change, adapted to suit the surface and preferences.

It is advisable to make a note of the default settings. These can then be used as a starting point for subsequent optimised settings and as a safeguard against unintentional changes.

6.5.12.1 Adjusting the sag for the SR SUNTOUR air suspension fork

Only applies to pedelecs with this equipment

- 1 Turn the **air valve cap** (see Section 3.4.5.1) anti-clockwise away from the **air valve (fork)**.
- 2 Attach high-pressure damper pump to the **air valve (fork)**.
- 3 Pump air suspension to the required pressure level. Stop at the levels specified in the SR SUNTOUR pressure table for air suspension forks. Never exceed the recommended maximum filling pressure.

Recommended air pressure [psi]						
Body weight [kg]	RUX38/Durolux38	Durolux36/Auron35/ Mobie35	Axon34-werx/elite	Aion35/Zeron 45 Mobie34-air/ Mobie45 air	Axon34/ Raidon 34/ XCR34	Axon32/Epixon32/ Raidon32/XCR32-air
< 55	< 40	35... 50	40... 55	35... 50	40... 55	40... 55
55... 65	40... 50	50... 60	55... 65	50... 60	55... 65	55... 65
65... 75	50... 60	60... 70	65... 75	60... 70	65... 75	65... 75
75... 85	60... 70	70... 85	75... 85	70... 85	75... 85	75... 85
85... 95	70... 85	85... 105	85... 100	85... 105	85... 100	85... 100
>95	+ 85	+105	+100	+105	+100	+100
Filling pressure set in the factory	70	90	95	90	95	110
Maximum pressure	105	120	145	120	145	145
Suspension operative up to body weight [kg]	118	128	138	109	138	138

Table 58: SR SUNTOUR filling pressure table for air suspension forks

Recommended air pressure [psi]						
Body weight [kg]	XCR 24" air	XCM-Jr.	Mobie25 air	GVX32	NRX-air	NCX-air
< 55	40... 55	40... 55	40... 55	40... 55	40... 55	40... 55
55... 65	55... 65	55... 65	55... 65	55... 65
65... 75	65... 75	65... 75	65... 75	65... 75
75... 85	75... 85	75... 85	75... 85	75... 85
85... 95	85... 100	85... 100	85... 100	85... 100
>95	+100	+100	+100	+100
Filling pressure set in the factory	50	50	100	110	85	80
Maximum pressure	100	100	130	120	120	120
Maximum body weight [kg]	100	100	124	114	114	114

Table 59: SR SUNTOUR filling pressure table for the air fork

- 4 Detach high-pressure damper pump.
- 5 Measure the distance between the fork crown and the dust seal. This distance is total deflection of the fork.
- 6 Push a cable tie attached temporarily downwards against the dust seal.
- 7 Put on normal pedelec clothing (including baggage).
- 8 Sit on the pedelec in your usual riding position and support yourself against an object, such as a wall or tree.
- 9 Get off the pedelec without it deflecting.
- 10 Measure distance between the dust seal and the cable tie.
⇒ This measurement is the sag. The recommended value is between 15% (hard) and 30% (soft) of the total fork deflection.
- 11 Increase or reduce the filling pressure.
⇒ The required sag is attained.
- 12 Tighten the **air valve cap** onto the **air valve (fork)** in a clockwise direction.

- 13 If you are unable to achieve the required sag, the fork will need to be adjusted internally. Contact specialist dealer.

Adjusting preload internally

- ▶ Only your specialist dealer may make an internal adjustment to the preload.

The air volume spacers can be replaced on some fork models. This changes the value for the centre stroke and the bottom-out (bounce) resistance.

- ▶ If the sag is set correctly and the deflection is reached too easily, install one or more spacers. This will increase the impact resistance.
- ▶ If the sag is set correctly and the full deflection range is not used, remove one or more spacers. Resistance to impact is reduced.

- 14 Check the sag.



Installation procedures and optimisation options as in the following table may be recommended:

			RUX38		Durolux36		Durolux38		Auron35		Mobie35		Axon34-werx	
Plastic volume spacer			8.6cc		8.2cc		7.5cc		
Rubber volume space			...		7.5cc-15 mm		7.5cc-15 mm		5cc-10 mm		5cc-10 mm		5cc-10 mm	
			Factory reset	max.spacer	Factory reset	max.spacer	Factory reset	max.spacer	Factory reset	max.spacer	Factory reset	max.spacer	Factory reset	max.spacer
Plastic volume spacer			5	5	3	3	3	3
Rubber spacer	Deflection [mm]	200
		180	2	6	1	6
		170	3	6	2	6
		160	4	6	3	6	7	10	7	11
		150	4	6	8	10	8	11
		140	9	10	9	11
		130	10	11
		120	11	11	3	8
		110	3	8
		100	3	8

Table 60: SR SUNTOUR – number of air volume spacers, EQ air system suspension forks

	Aion35		Zeron35		Axon32		Mobie34-air		Mobie45-air		GVX	
Rubber volume space	5cc		5cc		4.3cc		5cc		5cc		4.3cc	
Deflection [mm]	Factory reset	max.spacer	Factory reset	max.spacer	Factory reset	max.spacer	Factory reset	max.spacer	Factory reset	max.spacer	Factory reset	max.spacer
160	3	6
150	3	6	3	6
140	3	6	3	6
130	3	6	3	6
120	3	6	2	4
100	2	4	2	5	2	5
80	2	5	2	5
60	2	5	4	4
50	4	4
40	4	4

Table 61: SR SUNTOUR – number of air volume spacers, air system suspension forks

6.5.12.2 Adjusting the sag for the SR SUNTOUR steel suspension fork

Only applies to pedelecs with this equipment

You can pre-tension the steel suspension to adjust to the rider's weight and their preferred

riding style. It is not the coil spring hardness which is adjusted; it is its preload.

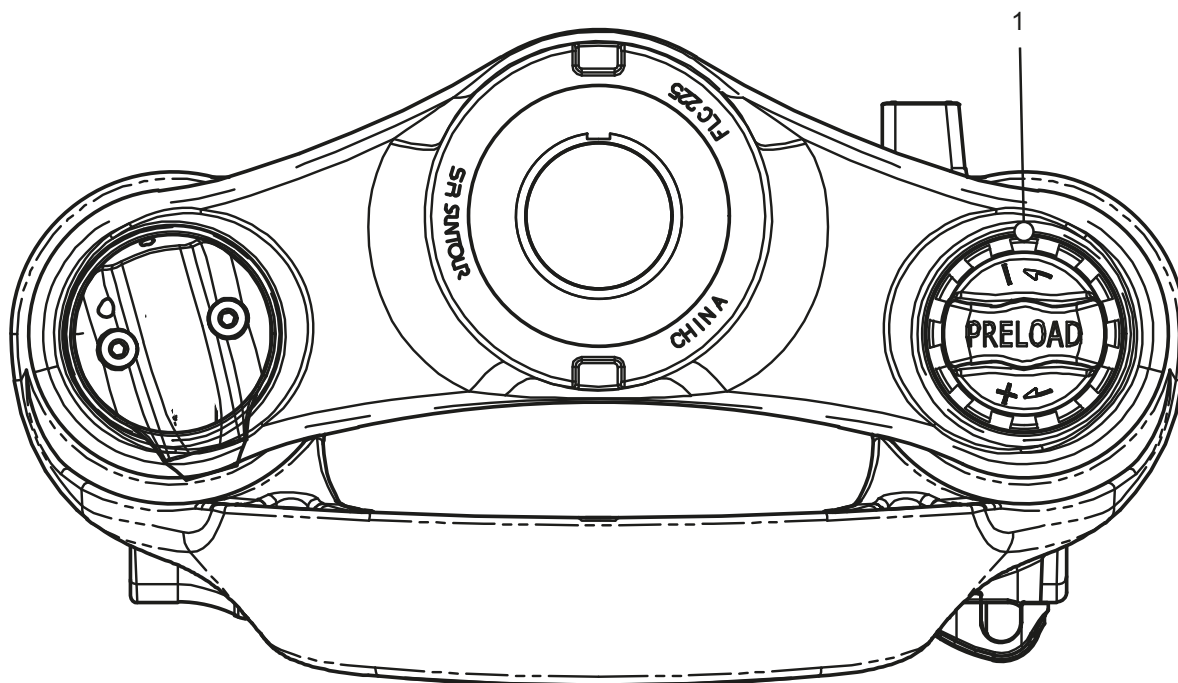

Figure 134: Example with SR SUNTOUR, sag setting wheel on the fork crown

- 1 Put on normal cycling clothing (including baggage).
- 2 Turn the **sag setting wheel** (see Section [3.4.5.1](#)) until the required sag is reached.
 - ▶ Turn the **sag setting wheel** clockwise.
 - ⇒ The spring preload is increased.
 - ▶ Turn the **sag setting wheel** anticlockwise.
 - ⇒ The spring preload is reduced.
- 3 If you are unable to achieve the required degree of hardness, contact your specialist dealer.

6.5.13 Adjust the rear frame damper sag

CAUTION

Crash caused by broken rear frame damper

If the rear frame damper's maximum air pressure is exceeded, this can cause the rear frame damper to break. This can result in loss of control and a crash with cut injuries or even death.

- ▶ Never exceed the indicated maximum air pressure when adjusting the sag.

Adjustments on the chassis change ride performance significantly. The rider needs to get used to the pedelec and break it in to prevent accidents.

The adjustment shown here represents a default setting. The rider should change the default setting to suit the surface and their preferences.

It is advisable to make a note of the default settings. These can then be used as a starting point for subsequent optimised settings and as a safeguard against unintentional changes.

Negative deflection (sag)

The sag is the percentage of total spring deflection that is compressed by the rider's body weight, including equipment (such as a backpack), their seating position and frame geometry. Sag is not caused by riding.

Greater sag

A greater sag increases sensitivity to bumps, thus producing greater suspension motion. A greater sensitivity to bumps ensures more comfortable ride performance and is used on pedelecs with a longer deflection.

Decreased sag

A decreased sag reduces sensitivity to bumps, thus producing less suspension motion. A lower sensitivity to bumps ensures a firmer, more efficient ride performance and is generally used on pedelecs with a shorter deflection.

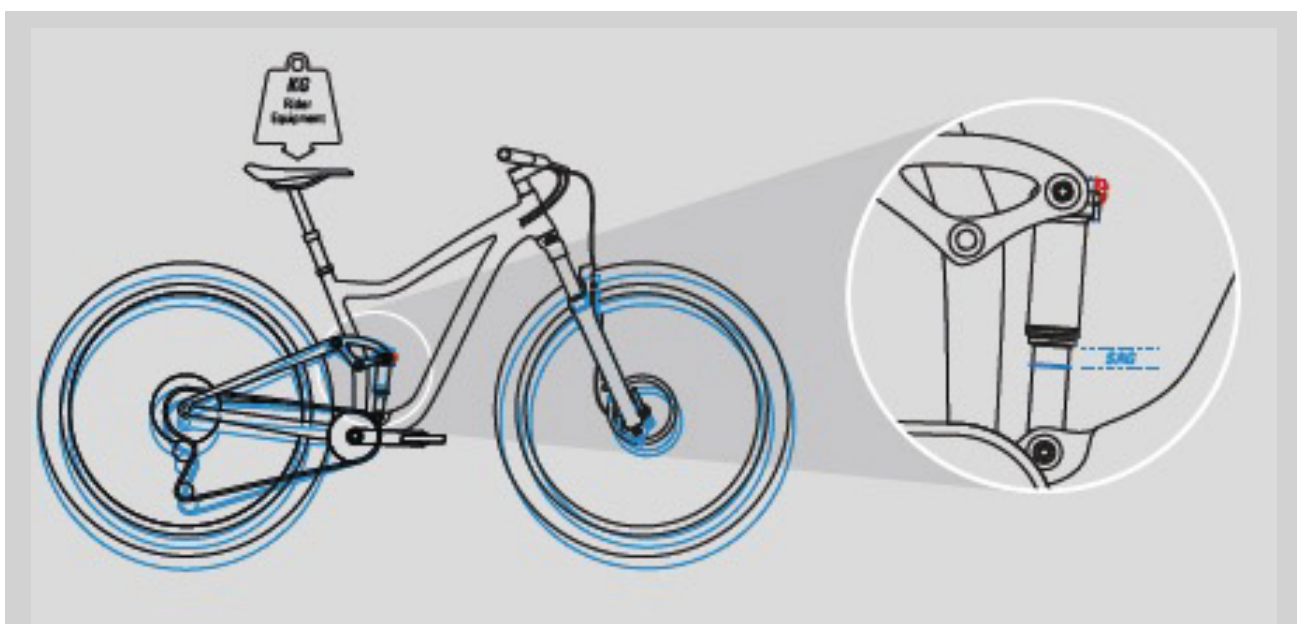

Figure 135: SAG rear frame damper

The rear frame damper rebounds at a controlled speed if it is optimally adjusted. The rear wheel does not bounce off rough surfaces or the ground; it stays in contact with the ground instead (blue line).

touches the ground after the bump. The rear frame damper rebounds in a controlled way, so that the rider remains sitting in a horizontal position when the next bump is absorbed. The suspension motion is predictable and controlled. The rider is not thrown upwards or forwards (green line).

The saddle is raised slightly if the bump is compensated and gently sinks downwards when the suspension deflects as soon as the wheel

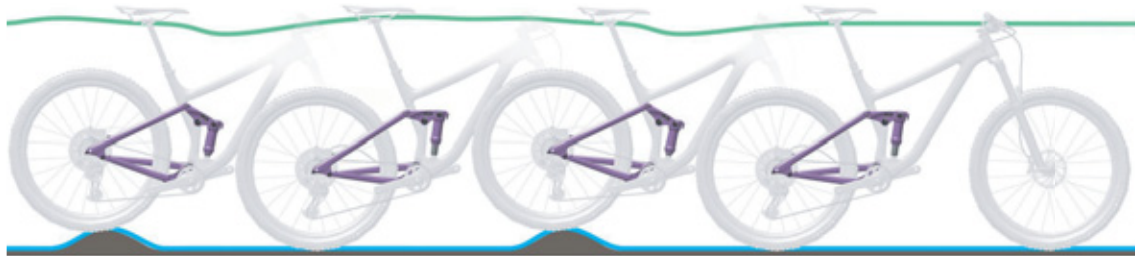

Figure 136: Optimum rear frame damper riding performance

When optimally adjusted, the rear frame damper counteracts deflection, stays higher in its

deflection range and helps to maintain speed when riding on hilly parts of terrain.

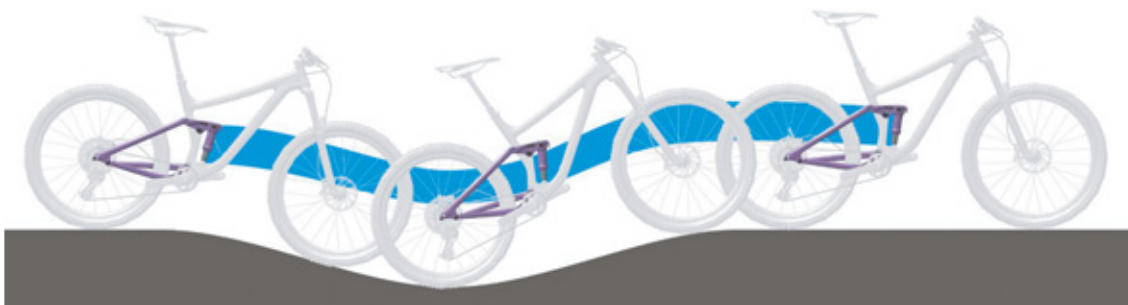

Figure 137: Optimum rear frame damper ride performance on hilly terrain

When optimally adjusted, the rear frame damper deflects quickly and unhindered when the bike hits bumps and absorbs a bump. Traction is retained (blue line).

The saddle rises slightly when absorbing a bump (green line).



Figure 138: Optimum rear frame damper ride performance over bumps

6.5.13.1 Adjusting Suntour sag for the rear frame damper

Only applies to pedelecs with this equipment

Every rear frame damper has a specific delivery air pressure ex works. These levels are starting points. These settings can be changed based on riding skills, trail conditions, frame design and personal preferences.

After setting up the rear wheel damper, check the sag to ensure the recommended sag settings are used.

Recommended air pressure [psi]										
	Vorocoil		Triair2		Triair		EDGE-comp	EDGE-Plus	EDGE	RAIDON
	Main body	Air reservoir	Main body	Air reservoir	Main body	Air reservoir	Main body	Main body	Main body	Main body
Pressure Factory reset	...	200	180	180	180	200	110	110	110	110
Maximum pressure	...	250	300	240	300	240	300	300	300	300

Table 62: Suntour rear frame damper filling pressure table

- ✓ The fork sag is adjusted.
 - ✓ The compression adjuster is set to OPEN.
- 1 Remove **valve cap** from the **air valve (rear frame damper)**.
 - 2 Attach a high-pressure damper pump to the **air valve (rear frame damper)**.
 - 3 Pump the damper to the required pressure. Never exceed the recommended maximum air pressure from the Suntour rear frame damper filling pressure table (see Table 62).

Notice

- ▶ If the air pressure in the rear frame damper is exceeded or undershot, the damper can be permanently damaged.
- 4 Remove high-pressure damper pump from the **air valve (rear frame damper)**.
 - 5 Apply force on the saddle to compress the rear frame damper several times by at least 50% of the full deflection.
- ⇒ This equalises the air pressure between positive and negative air chambers.

- 6 Measure the distance between the air chamber seal and the end of the rear frame damper. This distance is the total rear frame damper deflection.

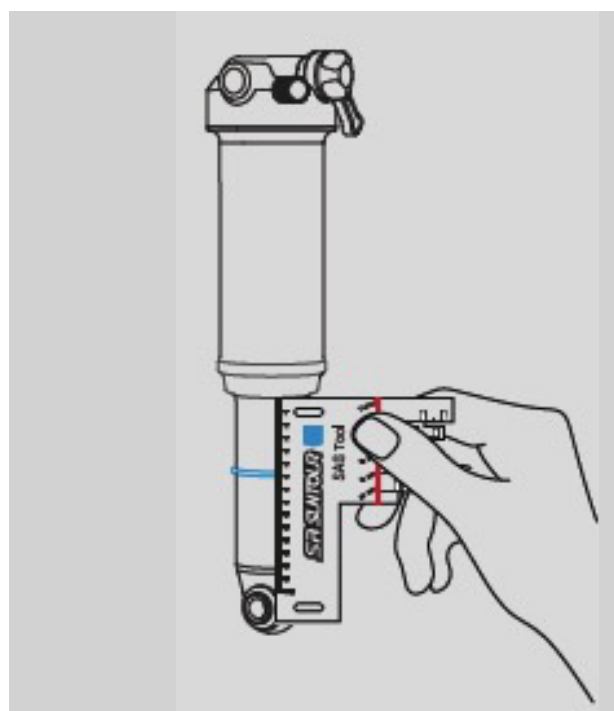

Figure 139: Measuring the total deflection

- 7 Attach cable tie if there is no O-ring on the damper body.
 - 8 Put on your normal cycling clothing, including baggage.
 - 9 Ask someone to hold the pedelec. Sit on the pedelec in your usual riding position and support yourself against an object, such as a wall or tree.
 - 10 Apply force on the saddle to fully deflect the rear frame damper gently two or three times.
 - 11 The helper pushes the O-ring or cable tie downwards against the air chamber seal.
 - 12 Get off the pedelec carefully, ensuring that the rear frame damper does not deflect.
 - 13 Measure the distance between the air chamber seal and the O-ring.
- ⇒ This measurement is the sag. The recommended value is between hard (lowest value) and soft (highest value).

Shock absorber deflection [mm]	Sag [%]	Distance [mm]
75	25... 35	18.75... 26.25
70		17.50... 24.50
65		16.25... 22.75
60		15.00... 21.00
55	25... 30	13.75... 16.50
50	20... 25	10.00... 12.50
45		9.00... 11.25
40		8.00... 10.00
35		7.00... 8.75
30		6.00... 7.50

Table 63: Recommended sag for the rear frame damper

- 14 The air pressure must be adjusted if the required sag level is not reached.
- ▶ Increase the air pressure to reduce the sag.
- ▶ Decrease the air pressure to increase the sag.

- 15 If the sag is correct, replace the **valve cap** on the **air valve (rear frame damper)**.
- 16 If you are unable to achieve the required sag, the fork will need to be adjusted internally. Contact specialist dealer.

Adjusting preload internally



- 1 Release all the air from the main reservoir.
- 2 Remove the O-ring from beneath the air chamber.
- 3 Rotate the high-pressure cuff (high volume) and press downwards.
- 4 Add or remove the required quantity of volume spacers.
- ▶ Adding air volume spacers creates a more progressive sensation when riding. A more progressive sensation prevents rough bottoming-out and stops the damper from remaining low in the deflection range.
- ▶ Removing air volume spacers creates a stronger, linear sensation when riding. It helps to remove the air volume spacers if the full deflection cannot be achieved or the rear frame damper becomes very hard at the end of the travel. Push high-pressure cuff upwards and tighten.
- ⇒ The air reservoir is air-tight.
- 5 Attach O-ring.

6.5.14 Fork rebound damping

Only applies to pedelecs with this equipment

Rebound damping in the suspension fork and the rear frame damper determines the speed at which the rear frame damper rebounds after being subjected to load. Rebound damping controls the suspension fork extension and rebound speed, which, in turn, has an impact on traction and control.

Rebound damping can be adjusted to body weight, spring stiffness, deflection, the terrain and the pedelec rider's preferences.

If the air pressure or spring stiffness increases, the extension and rebound speeds also increase.

Rebound damping needs to be increased to achieve an optimal setting if the air pressure or spring stiffness is increased.

The damper rebounds at a controlled speed if the fork is optimally adjusted. The wheel stays in contact with the ground when passing over bumps (blue line).

The fork head, handlebars and body follow terrain (green line) when riding over bumps. The suspension motion is predictable and controlled.

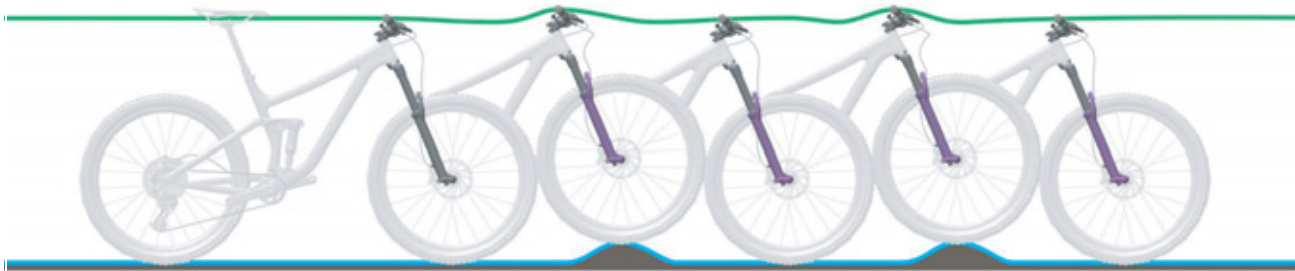

Figure 140: Optimum fork ride performance

6.5.14.1 Adjusting the SR SUNTOUR fork rebound damping

Only applies to pedelecs with this equipment

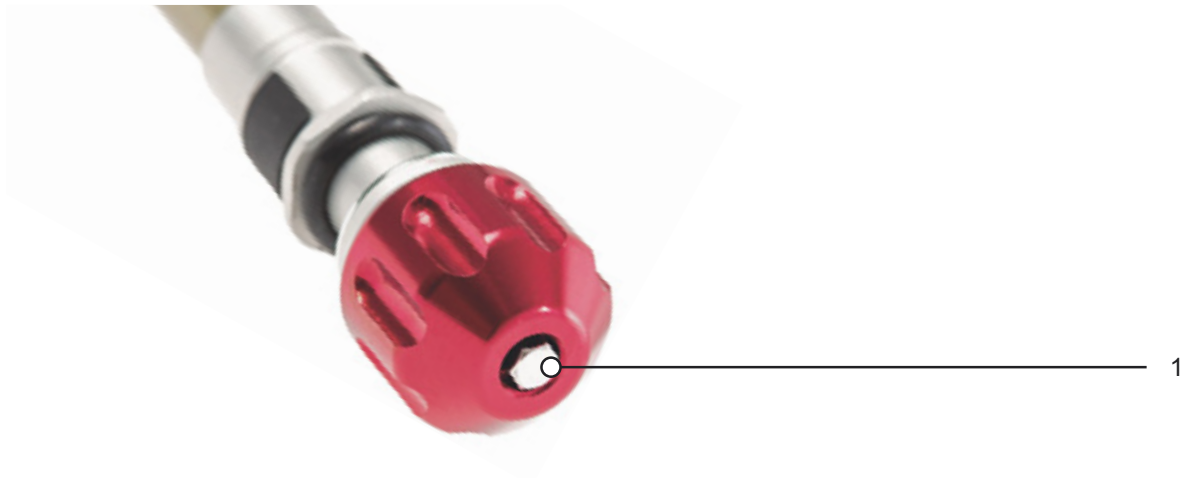

Figure 141: Example of SR SUNTOUR rebound screw (1)

- ✓ The fork sag is adjusted.
 - 1** Turn the rebound screw in a clockwise direction towards the closed position until it stops.
 - 2** Turn the **rebound screw** slightly in an anti-clockwise direction.
- ⇒ Adjust the rebound damper in such a way that the fork rebounds quickly, but without bottoming out upward. Bottoming out refers to when the fork rebounds too quickly and stops moving abruptly once it has reached the full rebound distance. You can hear and feel a slight impact when this happens.

6.5.15 Adjusting the rear frame damper rebound damper

Only applies to pedelecs with this equipment

The rear frame damper rebounds at a controlled speed if it is optimally adjusted. The rear wheel does not bounce off rough surfaces or the ground; it stays in contact with the ground instead (blue line).

The saddle is raised slightly if the bump is compensated and gently sinks downwards when the suspension deflects as soon as the wheel touches the ground after the bump. The rear

frame damper rebounds in a controlled way, so that the rider remains sitting in a horizontal position when the next bump is absorbed. The suspension motion is predictable and controlled. The rider is not thrown upwards or forwards (green line).

The rebound damper setting depends on the air pressure setting. A higher sag requires lower rebound damping.



Figure 142: Optimum rear frame damper riding performance

The suspension rebound speed affects the wheel's contact with the ground, which, in turn, has an influence on control and efficiency. The damper should rebound fast enough to sustain traction without producing an erratic or bumpy sensation. If rebound damping is too tight, the damper is unable to rebound fast enough before the next impact.

Adjust the rebound damping in such a way that the rear frame damper rebounds quickly, but without bottoming out upwards. Bottoming out refers to when the rear frame damper rebounds too quickly and stops moving abruptly once it has reached the full rebound distance. You can hear and feel a slight impact when this happens.

6.5.16 Setting high- and low-speed rebound damper in rear frame damper

Only applies to pedelecs with this equipment

Adjustment of the high-speed rebound (HSR) is advantageous for enabling the rear frame damper to quickly recover from heavier impacts and impacts on right-angled obstacles in order to absorb successive impacts.

Adjustment of the low-speed rebound (LSR) is useful to control the damper's suspension behaviour when brake pitching, during technically challenging climbs and when riding at an angle when additional traction is required.

6.5.16.1 Adjusting the Suntour rear frame damper

Only applies to pedelecs with this equipment

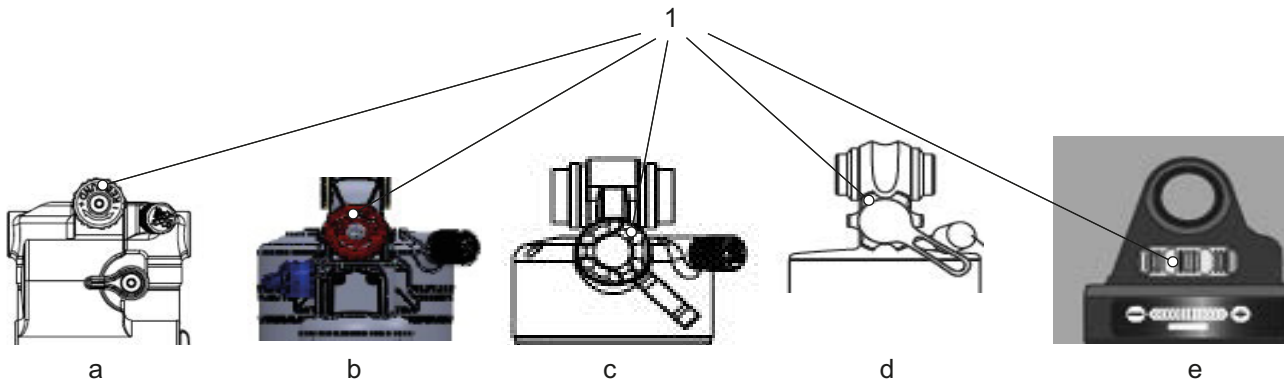

Figure 143: Position of RS Suntour rebound wheel for rear frame dampers Triair2 (a), Triair (b), EDGE-comp (c), EDGE (d) and RAIDON (e)

- ✓ The sag in the rear frame damper is adjusted.
- ▶ Turn **rebound adjuster wheel** clockwise.
 - ⇒ The rebound movement is slower; rebound damping is increased.
- ▶ Turn **rebound adjuster wheel** anti-clockwise.
 - ⇒ The rebound movement is faster; rebound damping is less forceful.

6.5.17 Riding light

6.5.17.1 Replacing the headlight

Not included in price



Headlights may only be replaced after approval by the manufacturer or system provider.

6.5.17.2 Replacing the rear light and (spoke) reflector

Not included in price



The rear light and (spoke) reflector may be replaced without special approval provided they comply with the laws of the country where the pedelec will be ridden.

6.5.17.3 Setting the riding light

Example 1

If the headlight is positioned too high, oncoming traffic will be dazzled. This can cause a serious accident with fatalities.

Example 2

Positioning the headlight correctly can ensure that oncoming traffic is not dazzled and no-one is put at risk.

Example 3

If the headlight is positioned too low, the space ahead is not illuminated to an optimum extent and the rider's vision is reduced in the dark.

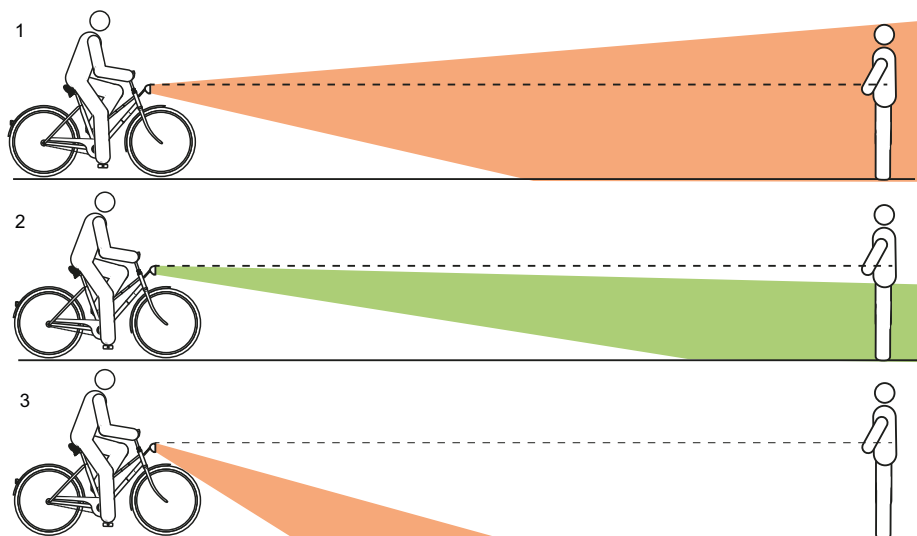

Figure 144: Light positioned too high (1), correctly (2) and too low (3)

6.5.17.4 Adjusting the headlight

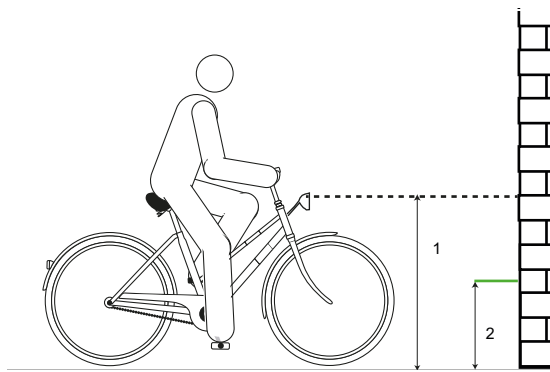

Figure 145: Measuring on the wall

- 1 Position the pedelec so that its front is facing a wall.
- 2 Mark the height of the headlight (1) on the wall with chalk.
- 3 Mark half the height of the headlight (2) on the wall with chalk.

- 4 Place pedelec 5 m in front of the wall.
- 5 Stand the pedelec up straight.

- 6 Hold the handlebars straight with both hands. Do not use the kickstand.
- 7 Switch on riding light.

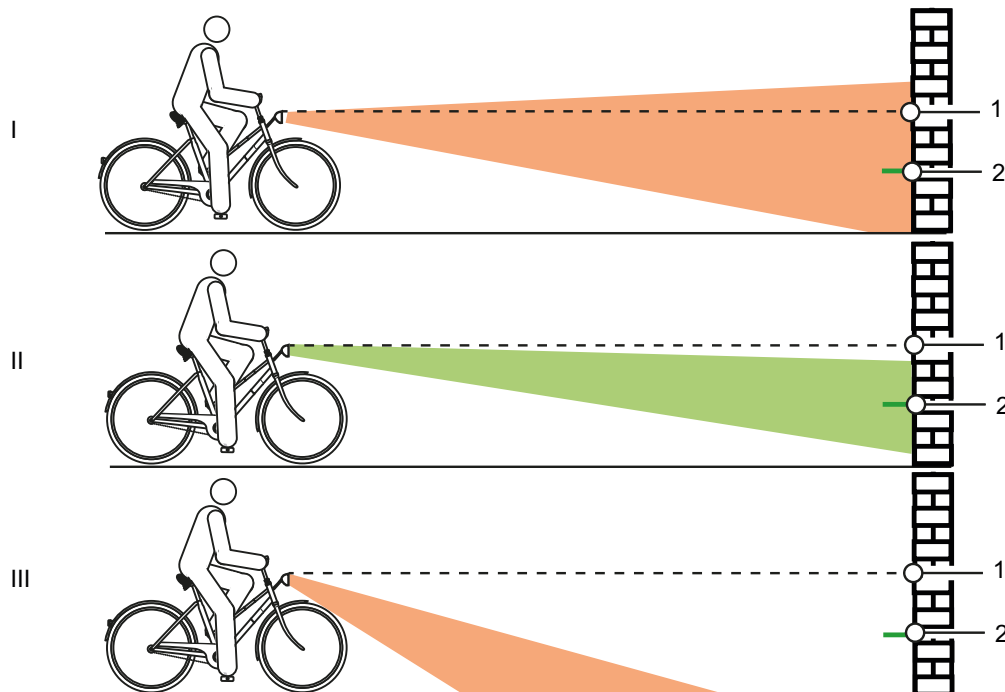

Figure 146: Light positioned too high (1), correctly (2) and too low (3)

- 8 Check the position of the light beam.
 - ▶ (I) if the upper edge of the light beam is above the headlight height mark (1), the riding light will dazzle. The headlight must be positioned lower.
 - ▶ If the mid-point of the light beam is on or slightly below the mark showing half the height of the headlight (2), the lighting is optimally positioned.
 - ▶ If the light beam is in front of the wall, move the headlight up.

6.5.18 Adjusting the on-board computer

A smartphone with the eBike Flow application is required to use all drive system functions. The pedelec is connected to the app via a Bluetooth® connection.

6.5.18.1 Creating a user account

The rider needs to register online and create a user account first.

Registering on a PC

- 1 Create the user account on the BOSCH website.
- 2 Enter all the details required for registration.

Registering on a smartphone

Apple iPhones

- ▶ Download the Bosch eBike Flow smartphone app from the App Store free of charge.

Android devices

- ▶ Download the eBike Flow smartphone app from the Google Play Store free of charge.

6.5.18.2 Connecting the on-board computer to a smartphone

- ✓ The BOSCH eBike Flow app is downloaded onto the smartphone.
- ✓ The drive system is switched on.
- ✓ The pedelec is stationary.

- 1 Launch app.
- 2 Select the <My eBike> tab in the app.
- 3 Select the <Add new eBike device> tab in the app.
- 4 Press the **On-Off button on the pedelec** for longer than 3 seconds.
 - ⇒ The top bar on the battery level indicator (on-board computer) flashes blue.
 - ⇒ The on-board computer will switch the Bluetooth® Low Energy connection on and change to pairing mode

- 5 Release the **On-Off button**.

- 6 Accept the connection prompt in the app.

- 7 Follow the instructions on the display.

- ⇒ The user data will be synchronised once the pairing process is complete.

6.5.18.3 Updating the software

Software updates are managed by the Bosch eBike Flow smartphone app.

- ✓ The on-board computer is now connected to the smartphone.
- ✓ The drive system is switched on.
- ✓ The pedelec is stationary.
- ⇒ A new software update is downloaded automatically onto the on-board computer.
- ⇒ The battery level indicator will flash green during updates to show how the update is progressing.
- ⇒ The system is restarted after an update has completed successfully.

6.5.18.4 Activating activity tracking

- ✓ Your location will only be logged if the on-board computer is connected to the Bosch eBike Flow smartphone app.
- ▶ Agree to activities being collected and stored on the platform or in the app.
- ⇒ All the pedelec's activities are stored and displayed on the platform and in the app.

6.5.18.5 Setting up the lock function (optional)

The user account can be used to activate the lock function. This will create a digital key on the smartphone, which is required to start the drive system.

Once the lock function is switched on, the pedelec can only be put into use if:

- the configured smartphone is switched on,
- the smartphone is charged sufficiently and
- the smartphone is directly next to the on-board computer.

If the key is not immediately verified on the smartphone, the battery level indicator and the display of selected level of assistance on the pedelec flash white to indicate a search for the key.

If the key is found, the battery level indicator flashes white. The last configured level of assistance is displayed. If the key cannot be found on the smartphone, the pedelec drive system switches off. The indicators on the on-board computer go off.

As the smartphone is only used as a contactless key to switch on the pedelec, the battery and on-board computer can still be used on another, unblocked pedelec.

6.5.18.6 Inserting the battery

- 1 Use a slotted-head screwdriver to pry open the battery compartment lid on the display rear.



Figure 147: Prying open the battery compartment lid

- 2 Insert new CR2450 battery. In doing so, ensure the seal rubber is in the right position.

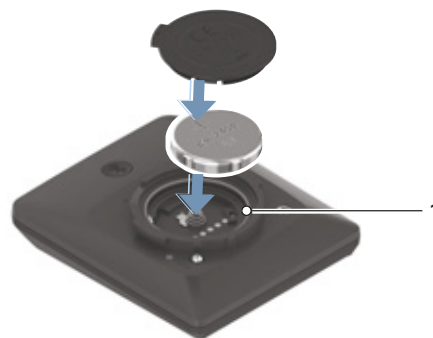

Figure 148: Inserting the battery with the seal rubber (1) aligned correctly

- 3 Press on the battery compartment lid.
- ⇒ The battery compartment is closed.

6.5.18.7 Inserting the display

- 1 Insert the battery compartment nub (1) into the bracket mount recess (2).
- 2 Gently press display downwards.

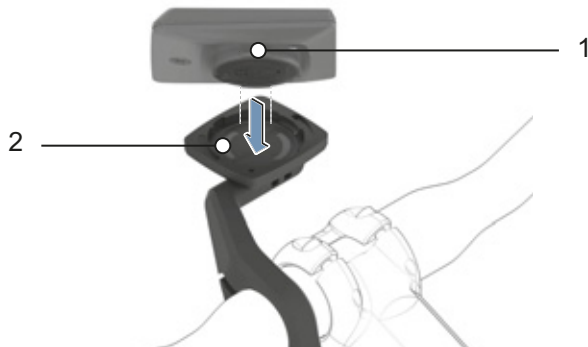

Figure 149: Putting the display into position

- 3 Turn display clockwise until it clicks into place.
- ⇒ The display is fastened into position.



Figure 150: Turning the display clockwise

6.5.18.8 Removing the on-board computer

- ✓ The display is not secured
- ▶ Turn the display anticlockwise to release.
- ▶ Remove the display from the mount recess in the display mount.

6.5.18.9 Securing the on-board display (optional)

It is possible to secure the on-board computer so that it cannot be removed. Inserting the blocking screw does not provide protection against theft.

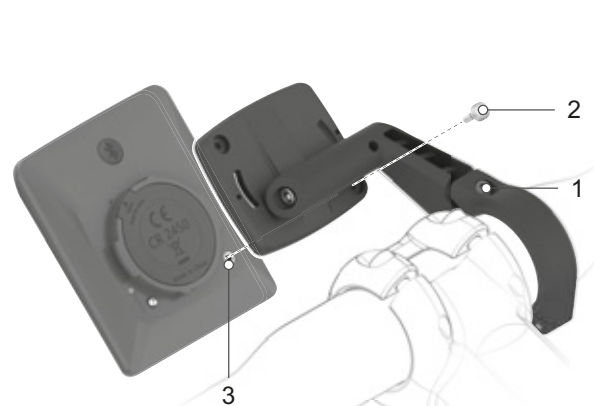

Figure 151: Position of headset screw

- ✓ The display is fastened into position.
- 1 Use a 3 mm hex key to unfasten the display mount (1) attachment screw.
- ⇒ The display mount can still move forwards.
- 2 Turn the display mount downwards until you can access the display's lower surface.
 - 3 Insert blocking screw (2) and fasten into the screw hole in the display (3).
 - 4 Turn the display mount back into its original position.
 - 5 Use a 3 mm hex key to fasten the display mount (1) attachment screw with 1 Nm.
- ⇒ The display can now only be removed if the blocking screw (2) is unfastened.

6.5.18.10 Adjusting the on-board computer

Notice

- ▶ Never use on-board computer, the display or the display mount as a handle. If the on-board computer, display or display mount are used to lift the pedelec, components can become irreparably damaged.

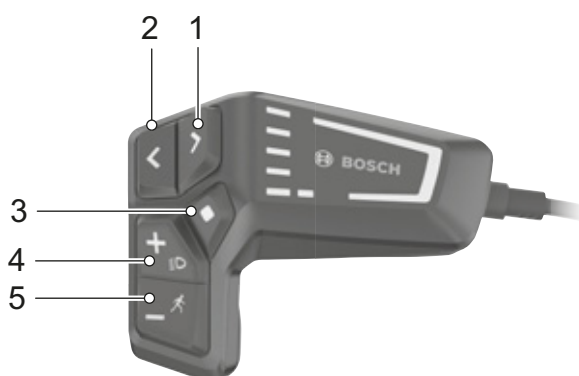

Figure 152: BOSCH LED Remote operating elements

	Symbol	Designation
1	>	Increase brightness button/ Forward button (scroll left)
2	<	Decrease brightness button/ Back button (scroll right)
3	◆	Select button
4	+	Plus button/ Light button
5	-	Minus button/ Push assist button

Table 64: Description of BOSCH LED Remote operating elements

You can use the **forward button** (7) and **back button** (8) to access the different user interfaces with information on ride values even when riding. This means both hands remain on the handlebars while you are cycling.

You can use the **plus button** (9) and the **minus button** (10) to increase and decrease the level of assistance. You can use the buttons to scroll up and down a list (such as the SETTINGS menu).

Opening the screens

- ▶ Press the **Forward button** or **Back button**.
- ⇒ A new screen is displayed.

Open Status screen

- 1 Open the **START SCREEN**.
 - 2 Press the **Back button**.
- ⇒ The **STATUS SCREEN** is displayed.

6.5.18.11 Adjust on-board computer

- ✓ The pedelec is stationary. You cannot open and adjust the settings while riding.
- ✓ Inserting the display.
- ✓ Switching on the electric drive system.

1 Press the **Select button** until <SETTINGS> appears on the **text display**.

⇒ The <BASIC SETTINGS> menu is now open.

2 Press the **Forward button** or the **Back button** until the required setting appears on the **text display**.

Submenu	Explanation
Change/exit basic settings	
<Language>	Sets preferred display language
<Units>	Sets speed and distance to kilometres or miles
<Time>	Adjusts the clock
<Time format>	Sets to 12- or 24-hour format
<Shift recommendation>	Switches shift recommendations on or off
<Backlight>	Sets duration of backlight activation
<Brightness>	Adjusts the display brightness
<Settings reset>	Resets all settings to their factory settings.

Table 65: Basic menu and submenu structure for Intuvia 100

3 Change the settings. Follow the instructions on the display to do so.

- ▶ Press the **select button** briefly until in the required value is displayed to change the basic settings.
- ▶ Press the **Back button** if the setting is correct.

⇒ You now exit the submenu. The changed values are saved automatically when you exit the submenu.

4 Press the **select button** briefly.

⇒ The <BASIC SETTINGS> menu is now closed.

6.5.18.12 Selecting the language

- 1 Open the <Language> submenu.
 - 2 Press the **select button** briefly until the required language is displayed.
 - 3 Press the **Back button**.
- ⇒ You now exit the submenu. The language has been set.

6.5.18.13 Selecting units

- 1 Open <Units> submenu.
 - 2 Press the **Select button** briefly to choose between kilometres and miles.
 - 3 Press the **Back button**.
- ⇒ You now exit the submenu. The unit has been selected.

6.5.18.14 Adjusting the clock

- 1 Open the <Time> submenu.
 - 2 Follow the instructions on the on-board computer.
- ⇒ The time has been set.
- 3 Press the **Back button** if the correct time has been set.
- ⇒ You now exit the submenu. The clock has been set.

6.5.18.15 Setting the time format

- 1 Open <Time format> submenu.
 - 2 Press the **Select button** briefly to choose between 12- and 24- hour format.
 - 3 Press the **Back button**.
- ⇒ You now exit the submenu. The Time Format is set.

6.5.18.16 Setting the shift recommendation

- 1 Open <Shift recommendation> submenu.
 - 2 Press the **Select button** briefly to choose between on and off.
 - 3 Press the **Back button**.
- ⇒ You now exit the submenu. The shift recommendation has been set.

6.5.18.17 Adjusting the backlight

- 4 Open <Backlight> submenu.
 - 5 Press the **Select button** briefly to select the duration of the backlight after pressing a button.
 - 6 Press the **Back button**.
- ⇒ You now exit the submenu. The backlight has been set.

6.5.18.18 Setting the brightness

- 1 Open <Brightness> submenu.
 - 2 Press the **Select button** briefly to choose one of the 5 increments.
 - 3 Press the **Back button**.
- ⇒ You now exit the submenu. The brightness has been set.

6.5.18.19 Resetting the settings

- 1 Open <Settings reset> sub-menu item.
 - 2 Press the select button briefly to return all settings to their original state on delivery.
 - 3 Press the **Back button**.
- ⇒ You now exit the submenu. All settings have been reset.

6.6 Accessories

Not included in price

6.6.1 Child seat



Child seats may only be used with the vehicle manufacturer's approval and only if they are approved for use on e-bikes.

WARNING

Crash caused by incorrect child seat

Pannier racks with a maximum load capacity under 27 kg and the down tube are unsuitable for mounting child seats and may break. Such an incorrect position may cause a crash with serious injuries for the pedelec rider or child.

- ▶ Never attach a child seat to the saddle, handlebars or down tube.

CAUTION

Crash caused by improper handling

When using child seats, the pedelec's handling characteristics and stability change considerably. This can cause a loss of control, a crash and injuries.

- ▶ You should practice how to use the child seat safely before using the pedelec in public spaces.

Risk of crushing due to exposed springs

The child may crush his/her fingers on exposed springs or open mechanical parts of the saddle or the seat post.

- ▶ Never install saddles with exposed springs if a child seat is being used.
- ▶ Never install suspension seat posts with open mechanical parts or exposed springs if a child seat is being used.

Notice

- ▶ Observe the legal regulations on the use of child seats.
- ▶ Observe the operating and safety instructions for the child seat system.
- ▶ Never exceed the maximum permitted total weight.

The specialist dealer will advise you on which child seat system is suitable for the child and the pedelec.

The specialist dealer must install the child seat the first time to ensure that it is safely fitted.

When installing a child seat, it must be ensured that:

- the seat and the seat fastening are suitable for the pedelec
- all components are installed and securely fastened
- shift cables, brake cables, hydraulic and electrical cables are adjusted as necessary
- the pedelec rider has optimum freedom of movement
- the maximum permitted total weight of the pedelec is observed.

The specialist dealer will provide instruction on how to handle the pedelec and the child seat.

6.6.2 Trailer



Trailers may only be used with the vehicle manufacturer's approval and only if they are approved for use on e-bikes.



Crash caused by brake failure

The braking distance may be longer if the trailer is carrying excessive load. The long braking distance can cause a crash or an accident and injuries.

- ▶ Never exceed the specified trailer load.

Notice

- ▶ The *operating* and safety instructions for the trailer system must be observed.
- ▶ Observe the statutory regulations on the use of bicycle trailers.
- ▶ Only use type-approved coupling systems.

A pedelec which is approved for towing a trailer will bear an appropriate adhesive label. You may only use trailers with a tongue load and weight which do not exceed the permitted values.

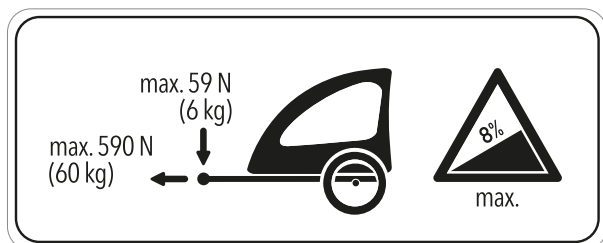

Figure 153: Trailer sign

The specialist dealer will advise you on which trailer system is suitable for the pedelec. The specialist dealer must install the trailer the first time to ensure that it is fitted safely.

6.6.2.1 Approval for trailer with Enviolo hub

Only applies to pedelecs with this equipment

Only compatible bicycle trailers are approved for ENVILO hub gears.

KETTLER

KETTLER Quadriga child trailer.

BURLY

Trailer	Adapter
Minnow Bee	Item no. 960038
Honey Bee	
Encore	
solo	
Cub	
D'Lite	
Normad	
Flatbed	
Tail Wagon	

CROOZER

Trailer	Adapter
Croozor Kid	Item no. 122003516, XL: +10 mm Item no. 122003716 Item no. 12200715 Croozor axle nut adapter with Thule coupling
Croozor Kid Plus	
Croozor Cargo	
Croozor Dog	

THULE

Trailer	Adapter
Thule Chariot Lite	Item no. 20100798
Thule Chariot Cab	
Thule Chariot Cross	
Thule Chariot Sport	
Thule Coaster XT	

6.6.2.2 Approval for trailer with ROHLOFF hub

Only applies to pedelecs with this equipment

ROHLOFF Speedhub 500/14

As a basic rule, it is permitted to use a trailer in combination with the ROHLOFF SPEEDHUB 500/14.

There must be **no component contact** with the cover of the ROHLOFF E-14 gear shift unit caused by pressure or tension at any time during assembly or when riding with the trailer **under any circumstances**.

Collision causing possible damage to the ROHLOFF E-14 gear shift unit can be avoided with suitable washers or special axle adapters (spacers or polygon) from the coupling manufacturer concerned.

Speedhub with A-12



Risk of an accident

The A-12 attachment screw has a very low screw-in depth. The screw or the thread in the axle plate can be damaged or ripped out if a trailer hitch is fitted directly onto the axle or the A-12 attachment screw. This may cause an accident with injuries.

- ▶ Never fit a trailer hitch directly on the axle and the A-12 attachment screw to a ROHLOFF Speedhub with an A-12 axle system in a 12 mm quick release axle frame.

6.6.3 Pannier rack



Front and rear pannier racks are only permitted with the vehicle manufacturer's approval and only if they are approved for use on e-bikes.

The specialist dealer will advise on choosing a suitable pannier rack.

The specialist dealer must install the pannier rack the first time to ensure that it is safely fitted.

When installing a pannier rack, the specialist dealer makes sure that the fastening mechanism is suitable for the pedelec and that all components are installed and firmly fastened. They will also ensure that shift cables, brake cables, hydraulic lines and electrical cables are adjusted as necessary, the person riding has optimum freedom of movement and the pedelec's maximum permitted total weight is not exceeded.

The specialist dealer will provide instruction on how to handle the pedelec and the pannier rack.

6.6.4 Panniers and cargo boxes



Panniers and cargo boxes are permitted if they are approved for use on e-bikes.

- ▶ Pay attention when loading the pannier rack and ensure correct load distribution.
- ▶ The maximum permitted total weight must not be exceeded during use.
- ▶ Use a paint protection film when attaching panniers. This will reduce abrasion on paint and wear on components.

The following panniers and cargo boxes are recommended:

Description	Article number
Protective cover for electrical components	080-41000 ff
Panniers, system component	080-40946
Rear wheel basket, system component	051-20603
Bicycle box, system component*	080-40947

Table 66: Recommended panniers and cargo boxes

6.6.5 Front baskets



Take care with front baskets because their load distribution is not fixed. They are only permitted with the vehicle manufacturer's approval and only if they are approved for use on e-bikes.

6.6.6 Bar ends



Handlebar ends are permissible provided they are professionally fitted to face the front at a specialist shop and only if they are approved for use on e-bikes. They must not seriously alter load distribution.

6.6.7 Kickstands



Kickstands are permitted if they are able to bear the weight of the pedelec.

We recommend a parking stand into which either the front wheel or rear wheel can be inserted securely for pedelecs which do not have a kickstand.

6.6.8 Additional battery headlight



Fitting additional battery headlights is permitted provided they comply with the laws of the country where the pedelec will be ridden and if they are approved for use on e-bikes.

6.6.9 Mobile holder

A holder for SP Connect mobile case is fitted to the stem.

- ✓ Observe the operating instructions for the mobile and the SP Connect mobile case.
- ✓ Use on tarmacked roads only.
- ✓ Protect mobile from theft.
- ▶ To attach: insert the SP Connect mobile case in the holder and turn 90° to the right.
- ▶ To release: turn the SP Connect mobile case 90° to the left and remove.

6.6.10 Suspension fork coil spring

If the desired suspension fork sag cannot be achieved after adjustment, the coil spring assembly must be replaced with a softer or harder spring.

- ▶ Fit a softer coil spring assembly group to increase the sag.
- ▶ Fit a harder coil spring assembly group to decrease the sag.

6.6.11 Fixed weather protection systems



Fixed weather protection systems are only permitted with the vehicle manufacturer's approval.

6.7 Personal protective equipment and accessories for road safety

Seeing and being seen is crucial in road traffic. The following requirements must be met for riding a pedelec safely on public roads.

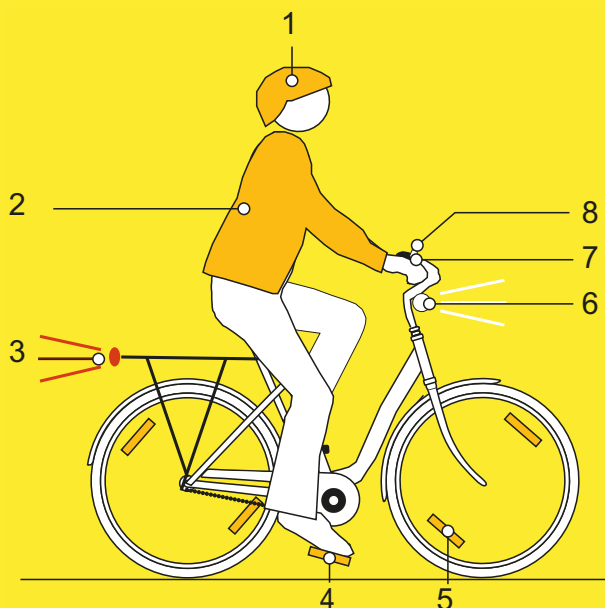

Figure 154: Road safety

- 1 The helmet must have a reflective strip or a light in a clearly visible colour.
- 2 **Cycle clothing** is essential at all times of year. Clothing should be retroreflective or as light as possible. Fluorescent materials are also suitable. High-visibility jackets and straps on your upper body ensure even greater safety. Never wear a skirt. Always wear trousers which reach down to your ankles instead.
- 3 The **large red reflector** with a “Z” registration mark and the **red rear light** must be clean. The rear light is attached high enough so that cars can see it (minimum height 25 cm). The rear light must work.
- 4 The two **reflectors on the two non-slip pedals** must be clean.
- 5 The **yellow spoke reflectors** on both wheel or the **white, fluorescent surface** on both wheels must be clean.
- 6 The **white front light** must work and must be positioned so that it does not dazzle other road users. The white front light and the **white reflector** must be clean at all times.

- 7 The **two separate brakes** on the pedelec must work at all times.
- 8 The **clear sounding bell** must be fitted and must work.

6.8 Before each ride

- ▶ Check pedelec before each ride; see Section [7.1](#).

Check list before each ride		
<input type="checkbox"/>	Check everything is sufficiently clean.	See Section 7.2
<input type="checkbox"/>	Check guards.	See Section 7.1.1
<input type="checkbox"/>	Check battery to ensure it is firmly in place.	See Section 6.17
<input type="checkbox"/>	Check lights.	See Section 7.1.13
<input type="checkbox"/>	Check brake.	See Section 7.1.14
<input type="checkbox"/>	Check suspension seat post.	See Section 7.1.9
<input type="checkbox"/>	Check pannier rack.	See Section 7.1.5
<input type="checkbox"/>	Check bell.	See Section 7.1.10
<input type="checkbox"/>	Check handles.	See Section 7.1.11
<input type="checkbox"/>	Check rear frame damper.	See Section 7.1.4
<input type="checkbox"/>	Check frame.	See Section 7.1.2
<input type="checkbox"/>	Check wheel concentricity.	See Section 7.1.7
<input type="checkbox"/>	Check quick releases.	See Section 7.1.8
<input type="checkbox"/>	Check mudguards.	See Section 7.1.6
<input type="checkbox"/>	Check USB cover.	See Section 7.1.12

- ▶ Be alert to any unusual noises, vibrations or odours while riding. Be alert to any unusual operating sensations when braking, pedalling or steering. This indicates material fatigue.
- ⇒ Take pedelec out of service if there are any deviations from the “Before each ride” checklist or any unusual behaviour. Contact specialist dealer.

6.9 Straightening the quickly adjustable stem

Only applies to pedelecs with this equipment

- 1 Open stem clamping lever.

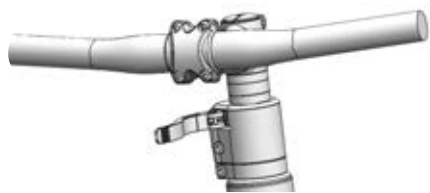

Figure 155: Example of All Up with open stem clamping lever

- 2 Pull handlebars into the highest possible position.

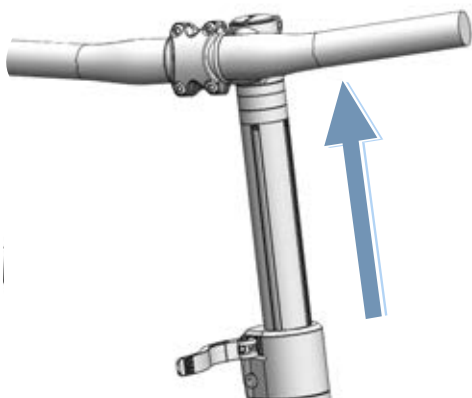

Figure 156: Example of All Up pulled into highest possible position

- 3 Turn handlebars 90° anti-clockwise so that they are straight.

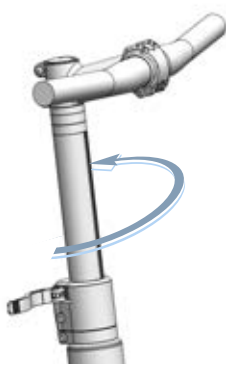

Figure 157: Example of All Up in straight position

- 4 Place handlebars at required height.
- 5 Close stem clamping lever.

6.10 Using the pannier rack

CAUTION

Crash caused by loaded pannier rack

The pedelec is handled differently with a loaded *pannier rack*, in particular when the rider needs to steer and brake. This can lead to a loss of control. This may cause a crash with injuries.

- ▶ You should practice how to use a loaded *pannier rack* safely before using the pedelec in public spaces.

Crushing the fingers in the spring flap

The spring flap on the *pannier rack* operates with a high clamping force. There is a risk of crushing the fingers.

- ▶ Never allow the spring flap to snap shut in an uncontrolled manner.
- ▶ Be careful where you position your fingers when closing the spring flap.

Crash caused by unsecured baggage

Loose or unsecured objects on the *pannier rack*, e.g. belts, may become caught in the rear wheel. This may cause a crash with injuries.

Objects which are fastened to the *pannier rack* may cover the *reflectors* and the *riding light*. Other users may not see the pedelec on public roads as a result. This may cause a crash with injuries.

- ▶ Secure any objects which are attached to the *pannier rack* sufficiently.
- ▶ Objects fastened to the *pannier rack* must never cover the *reflectors*, the *headlight* or the *rear light*.

- ▶ Distribute the baggage as evenly as possible between the left- and right-hand side.
- ▶ We recommend the use of panniers and baggage baskets.



Figure 158: The maximum load bearing (1) capacity is indicated on the pannier rack

- ▶ Pack the pedelec to its *maximum permitted total weight* (PTW) only.
- ▶ Pack the pedelec to the pannier rack's (1) maximum load capacity only.
- ▶ Use the original pannier rack only.

6.11 Raising the kickstand

- ▶ Use your foot to raise kickstand completely before setting off.

6.12 Using the saddle

- ▶ Do not wear studded jeans as these can damage the saddle covering.
- ▶ Wear dark clothes for your first few rides as new leather saddles can stain clothing.

Riders often experience pain in the sitting bones, especially beginners or at the start of the season, after a longer break. The periosteum around the sitting bones is irritated as it is unaccustomed to the chafing. To reduce chafing:

- ▶ Wear cycling shorts with shock-absorbing seat padding
 - ▶ ULEDse a chamois cream or ointment.
- ⇒ The sensation of pain is reduced after five to six rides, although it may increase again after two to three weeks of riding.

6.12.1 Using the leather saddle

Sunlight and UV light tarnish the colour and cause the leather to dry out and fade.

- ▶ Park pedelec in the shade.
- ▶ Always use a saddle cover.

Moisture may cause the leather to detach from material beneath and mould may form.

- ▶ If the leather saddle gets wet, dry saddle completely.
- ▶ Always use a saddle cover.

6.13 Using the pedals

- ▶ The ball of the foot is placed on the pedal when riding and pedalling.

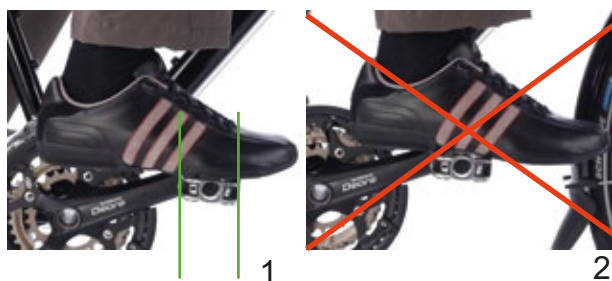

Figure 159: Correct (1) and incorrect (2) foot position on the pedal

6.14 Using the bell

- 1 Press the bell button downwards.
- 2 Let button spring back.

6.15 Using the handlebars

- ▶ Wear heavily padded cycling gloves.
- ⇒ This helps protect sensitive areas of your palms.
- ▶ Vary your grip position continuously while riding.
- ⇒ This prevents overstraining and fatigue in your hands.

6.15.1 Using multi-position handlebars

Only applies to pedelecs with this equipment

Multi-position handlebars are ideal for dynamic riding. The contoured ends of the handlebars, also known as horn handlebars, provide a variety of grip options. Changing muscle groups reduces strain on the hands, arms and back during longer rides.

- ▶ Vary your grip position continuously while riding.
- ⇒ This prevents overstraining and fatigue in your hands.



Figure 160: Grip positions on the multi-position handlebars

Grip position 1

The top grip position is suitable for riding slowly.

- ▶ Straighten your upper body without tensioning in this position.

Grip position 2 and 3

The middle and bottom grip position is suitable for fast rides and riding on inclines.

- ▶ In the middle position, hold the arm and wrist upright and relax tension.
- ▶ In the bottom position, place your upper body slightly lower. Keep your fingers close to the brake handle ready for use.

6.15.2 Using bar ends

Only applies to pedelecs with this equipment

Bar ends can be added to normal handlebars.

Adjustable bar ends feature a ball joint which you can use to choose the optimum position as required.

- ▶ Adjust bar ends correctly. To do so, your hand, elbow and shoulder must be in line with one another when the hand takes hold of the bar ends
- ▶ During the ride, keep varying your grip position between a flat (1) and upright (2) hand position.
- ⇒ This prevents overstraining, fatigue and numbness in your hands and fingers.

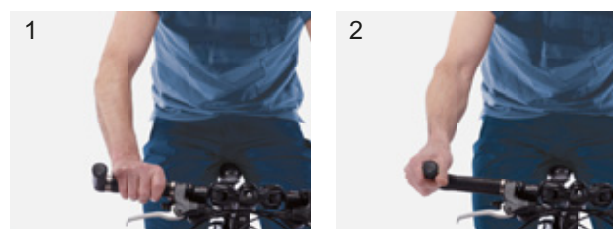

Figure 161: Grip positions on a bar end

6.15.3 Using leather handles

Only applies to pedelecs with this equipment

Sweat and grease from the skin are two of the greatest enemies of leather. They penetrate the surface of leather and cause it to disintegrate more quickly, meaning the leather can soften and abrade.

- ▶ Wear gloves.

Sunlight and UV light damage the colour and can cause the leather to dry out and fade.

- ▶ Park pedelec in the shade.

Moisture may cause the leather to detach from material beneath and mould may form.

- ▶ If the leather handles get wet, dry handles completely.

6.16 Use suspension and damping

6.16.1 Locking the suspension

A suspension system is designed to cushion and compensate for unevenness on a surface whether the user is riding on bumpy cycle paths, dirt roads or off road.

A suspension system absorbs a great deal of motor and muscle power during rides uphill or on optimally tarmacked roads. This increases energy consumption and reduces propulsion. It thus makes sense to lock the suspension on tarmacked roads and when riding uphill.

Some suspension forks thus feature a lockout on the fork crown or a remote lockout on the handlebars.

	Mode	Use
1	OPEN	Setting off
2	Middle position	Bumpy roads
3	LOCK	Uphill or tarmacked roads

6.16.1.1 Locking the SR SUNTOUR suspension fork

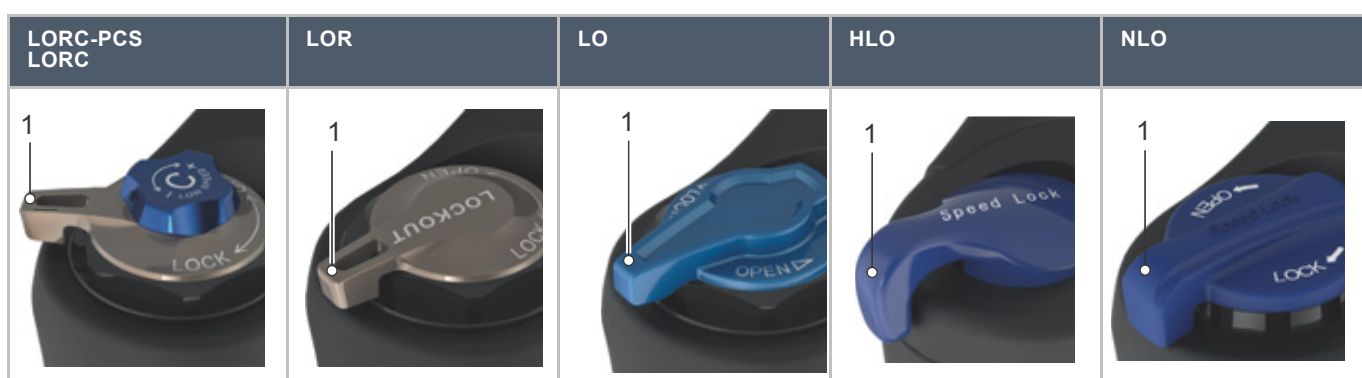

Table 67: Lockout on the fork crown on SR Suntour suspension forks

► Turn **lockout** (1) on the fork crown clockwise to LOCK.

⇒ The suspension fork is blocked.

► Turn **lockout** (1) on the fork crown anticlockwise to OPEN.

⇒ The suspension fork is open.



Table 68: SR Suntour suspension fork lockout on the handlebars

► Press **locking lever** (1) on the handlebars.

⇒ The suspension fork is blocked.

► Press **release lever** (2) on the handlebars.

⇒ The suspension fork is open.

6.16.1.2 Locking the SR SUNTOUR rear frame damper

Only applies to pedelecs with this equipment

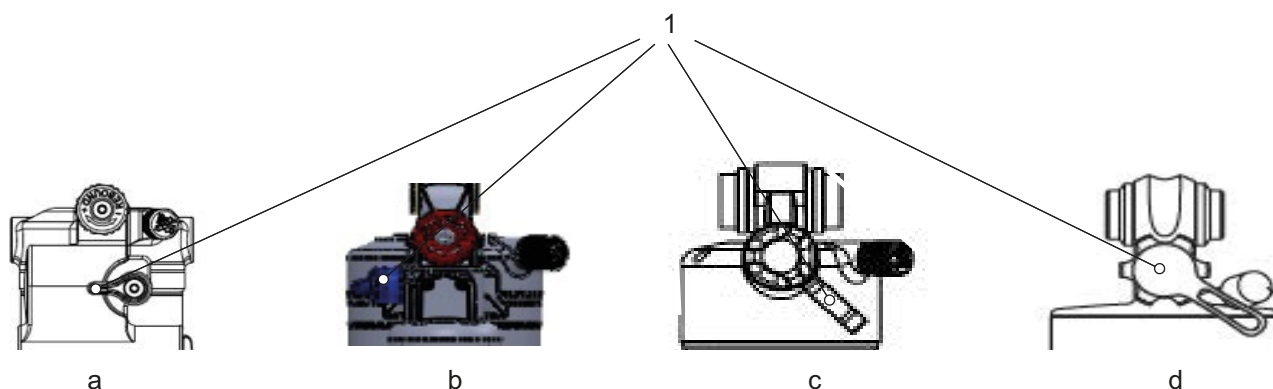

Figure 162: Position of RS Suntour rebound adjuster on rear frame dampers Triair2 (a), Triair (b), EDGE-comp (c) and EDGE (d)

- ✓ The pedelec's sag is configured.
- ✓ The pedelec's rebound damping has been set.
- ▶ Place **compression stroke lever** or, if present, the lockout lever on the handlebars at the LOCKOUT position.
- ⇒ The rear frame damper is locked.

CAUTION

Crash caused by damaged rear frame damper

The rear frame damper can be damaged if it is compressed under high stress load. This may lead to an accident with injuries.

- ▶ Never select the LOCK setting on off-road rough terrain or when the suspension is subject to high stress loads.

6.16.2 Adjusting the suspension fork compression damper

The compression damper allows the rider to make quick adjustments to the suspension behaviour of the suspension fork to adapt to changes in terrain. It is intended for adjustments made during the ride.

It is a good idea to use the compression damper on

- bumpy sections
- marked shifts of weight at crossings and during cornering and braking.

When placed at an optimum setting, the suspension fork counteracts deflection on hilly terrain, remains higher in its deflection range and helps maintain speed when riding on terrain hilly sections.

The suspension fork also deflects quickly and unhindered when hitting bumps and cushions the bump when placed at an optimum setting. Traction is retained (blue line). The fork responds quickly to the bump. The headset and handlebars rise slightly when absorbing a bump (green line).



Figure 163: Optimum ride performance on hilly terrain

Compression damper set to hard

- Causes the suspension fork to move higher within the deflection range. This makes it easier for the rider to improve efficiency and maintain momentum over uniformly hilly terrain and around bends.
- Deflection feels somewhat harder on bumpy terrain.

Compression damper set to soft

- Causes the suspension fork to deflect quickly and easily. This makes it easier to maintain speed and momentum when riding on bumpy terrain.
- Deflection may feel somewhat less hard on more rugged terrain.



6.16.2.1 Using the SR Suntour low-speed compression damping

Low-speed movement in the suspension fork is caused, for example, by riding over bumps.

The settings of the low-speed damper control the suspension behaviour of the fork

- during staggered jumps
- during shifts in the rider's body weight
- when force is applied slowly.



Figure 164: Low-speed movements

R2C2-PCS R2C2 RC2 RC2-PCS	RC-PCS RC	RLRC-PCS RLRC	LORC-PCS LORC

Table 69: Low-speed lever (1) on the SR Suntour suspension fork on the fork crown

- ▶ Turn **low-speed lever (1)** on the fork crown gradually in a clockwise direction.
- ⇒ The low-speed compression damper is placed in a harder setting.

- ▶ Turn **low-speed lever (1)** on the fork crown gradually in an anticlockwise direction.
- The low-speed compression damper is placed in a softer setting.

6.16.3 Adjusting the rear frame damper compression damper

When optimally adjusted, the rear frame damper deflects quickly and unhindered when the bike hits bumps and absorbs a bump. Traction is retained (blue line).

The saddle rises slightly when absorbing a bump (green line).

Compression adjuster set to hard

- Allows the rear frame damper to move higher in the deflection range. This makes it easier to improve efficiency and maintain momentum when pedalling or riding over uniformly hilly terrain and around bends.
- Deflection feels somewhat harder on bumpy terrain.

Compression adjuster set to soft

- Allows the damper to deflect quickly and easily. This makes it easier to maintain speed and momentum when riding over bumpy terrain.
- Deflection feels somewhat less hard on bumpy terrain.



Figure 165: Optimum rear frame damper ride performance over bumps

Threshold

The damping threshold prevents deflection until a medium impact or downward force occurs. Threshold mode increases drive efficiency over level terrain.

The threshold setting can be used to improve pedalling efficiency over flat, hilly, level or slightly rugged terrain. In threshold mode, higher pedelec speeds lead to greater impact force when a pedelec hits a bump, causing the fork to deflect, and the bump is absorbed.

	Mode	Use
1	OPEN	Ideal for setting off The rear frame damper quickly deflects unhindered through its entire deflection range.
2	THRESHOLD	Ideal for saving energy while riding on roads and/or for maximum pedalling efficiency on flat or smooth terrain. When the threshold is activated, the rear frame damper counteracts deflection until a medium bump or downward force occurs.
3	LOCK	Tarmacked roads (see Section 6.16.1) The locked rear frame damper counteracts deflection until a strong impact or upward force occurs.

6.16.3.1 Adjusting the SR Suntour compression damper

Only applies to pedelecs with this equipment

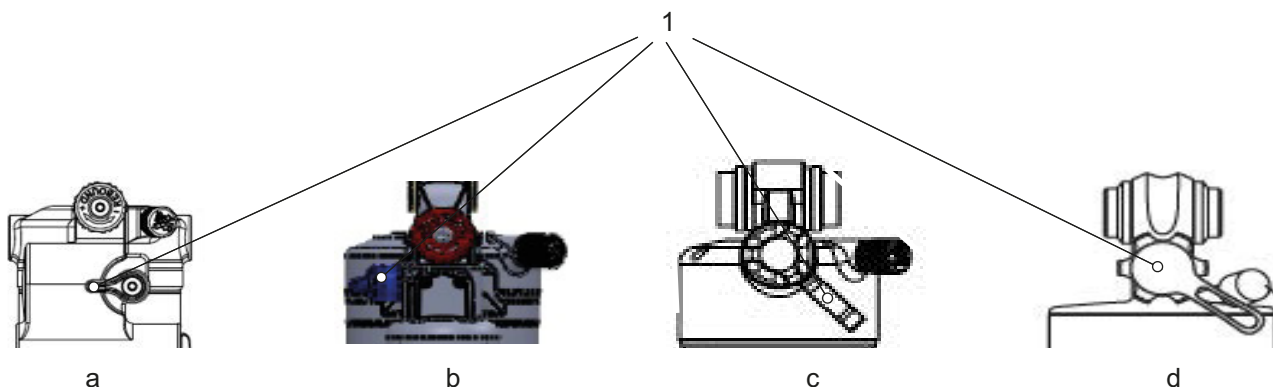

Figure 166: Position of RS Suntour compression adjuster on rear frame dampers Triair2 (a), Triair (b), EDGE-comp (c) and EDGE (d)

- ✓ The pedelec’s sag is configured.
- ✓ The pedelec’s rebound damping has been set.
- ✓ Adjust the compression damper to the terrain before setting off.
- ▶ **Set the compression adjuster** to the required mode.

	Mode	Use
1	OPEN	Ideal for setting off The rear frame damper quickly deflects unhindered through its entire deflection range.
2	THRESHOLD	Ideal for saving energy while riding on roads and/or for maximum pedalling efficiency on flat or smooth terrain. When the threshold is activated, the rear frame damper counteracts deflection until a medium bump or downward force occurs.
3	LOCK	Tarmacked roads (see Section 6.16.1) The locked rear frame damper counteracts deflection until a strong impact or upward force occurs.

CAUTION

Crash caused by damaged rear frame damper

The rear frame damper can be damaged if it is compressed under a high stress load. This may lead to an accident with injuries.

- ▶ Never select the LOCK setting on off-road rough terrain or when the suspension is subject to high stress loads.

6.17 Using the battery

- ✓ Switch off the battery and the drive system before removing or inserting the battery.

6.17.1 Removing the battery

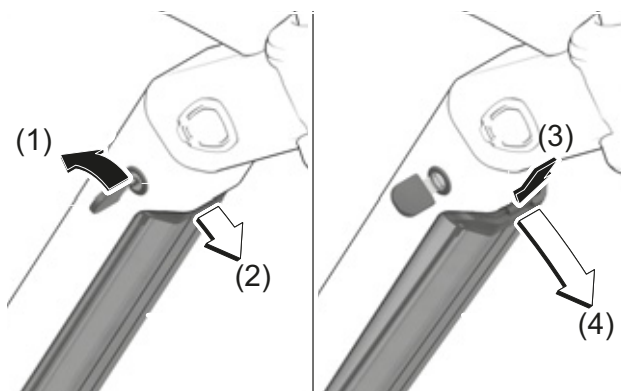

Figure 167: Removing the integrated battery

- 1 Open battery lock with battery key (1).
 - ⇒ The battery is released and falls into the retainer guard (2).
- 2 Hold the battery in your hand from below. Use the other hand to push on the retainer guard from above (3).
 - ⇒ The battery is released and falls into the hand (4).
- 3 Remove the battery from the frame.
- 4 Remove the battery key from the battery lock.

6.17.1.1 Inserting the battery

- ✓ The key is inserted in the lock.
- ✓ The lock is unlocked.

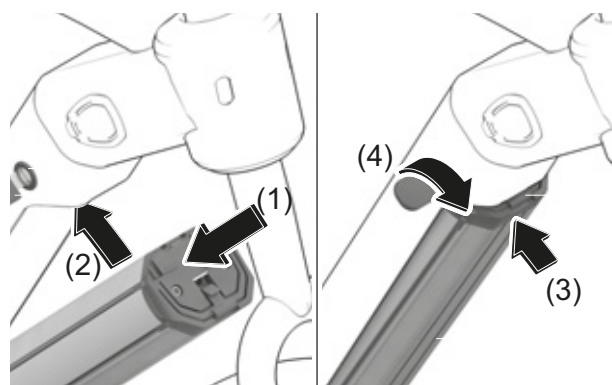

Figure 168: Inserting the integrated battery

- 1 Place the battery into the lower mount with the contacts facing the front (1).
- 2 Flip the battery upwards so that the battery is held by the retainer guard (2).
- 3 Keep the lock open with the key.
- 4 Push the battery upwards (3).
 - ⇒ The battery can be heard locking into place.
- 5 Check battery to ensure it is firmly in place on all sides.
- 6 Lock the battery with the battery key; otherwise, the battery may fall out of the mount when you open the see (4).
- 7 Remove the battery key from the battery lock.
- 8 Check the battery to ensure it is firmly in place before each ride.

6.17.2 Charging the battery

The battery can remain on the pedelec or can be removed for charging. Interrupting the charging process does not damage the battery. The battery is fitted with a temperature monitoring system which only allows charging within a temperature range between 0 °C and 40 °C.

- ✓ The ambient temperature during the charging process lies within the range between 0 °C to 40 °C.
- 1 Remove the cable connection cover if necessary.
 - 2 Connect the mains plug of the charger to a normal domestic, grounded socket.

Connection data	230 V, 50 Hz
-----------------	--------------

Notice

- ▶ Check that mains voltage! The power source voltage must match the voltage indicated on the charger nameplate. Chargers labelled 230 V may be operated at 220 V.
-
- 3 Connect the charging cable to the battery's charging port.
- ⇒ The charging process starts automatically.
 - ⇒ The battery level indicator shows the charge level during charging. When the drive system is switched on, the *on-board computer* displays the charging process.

Notice

If an error occurs during the charging process, a system message is displayed.

- ▶ Remove the charger and battery from operation immediately and follow the instructions.
-
- ⇒ The charging process is complete when the LEDs on the battery level indicator go out.
- 4 Once charging is complete, disconnect the battery from the charger.
 - 5 Disconnect the charger from the mains.

6.18 Using the electric drive system

6.18.1 Switching on the electric drive system



Crash caused by lack of readiness for braking

When it is switched on, the drive system can be activated by the application of force on the pedals. There is a risk of a crash if the drive is activated unintentionally and the brake is not reached.

- ▶ Never start the electric drive system, or switch it off immediately, if the brake cannot be reached safely and reliably.

- ✓ A sufficiently charged battery has been inserted into the pedelec.
- ✓ The battery is firmly positioned and locked. The battery key has been removed.
- ✓ The speed sensor is connected correctly.

There are two options for switching on the drive system.

On-Off button (on-board computer)

- ▶ Press the **On-Off button (on-board computer)** briefly (< 3 seconds).

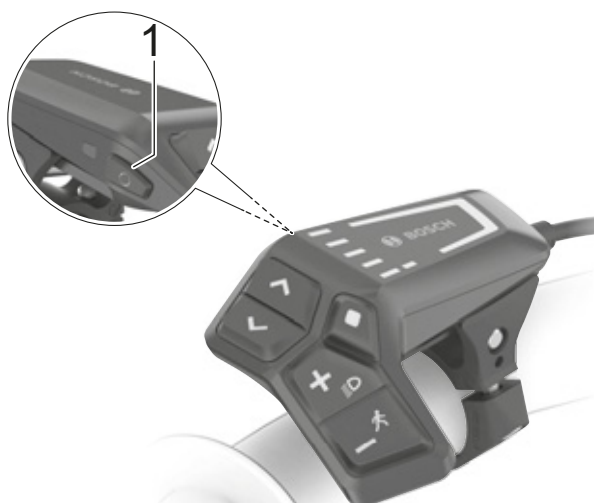

Figure 169: Position of the On-Off button on the BOSCH LED Remote

On-Off button (battery)

- ▶ Press the **On-Off button (battery)** briefly.
 - ⇒ All LEDs on the on-board computer will light up briefly.
 - ⇒ The battery level is displayed in colour by the battery level indicator (on-board computer) and the configured level of assistance by the indicator for the selected level of assistance. The pedelec is ready to ride.
 - ⇒ If the battery capacity is less than 5%, the battery level indicator will remain dark. Only the on-board computer indicates whether the drive system is switched on or not.

If the drive system is switched on, the drive is activated as soon as the pedals are moved with sufficient force (except if the selected level of assistance is "OFF"). The motor power is based on the level of assistance selected on the on-board computer.

6.18.2 Switching off the electric drive system

As soon as the rider stops pushing the pedals in normal mode or reaches a speed of 25 km/h, the drive system switches off the assistance system. The assistance system starts up again when you push the pedals and your speed is less than 25 km/h.

The system switches off automatically ten minutes after the last command.

There are two options for switching off the drive system manually.

On-Off button (on-board computer)

- ▶ Press the **On-Off button (on-board computer)** briefly (< 3 seconds).

On-Off button (battery)

- ▶ Press the **On-Off button (battery)**.
 - ⇒ The battery level indicator (on-board computer) and the indicator for the selected level of assistance go out.
 - ⇒ The pedelec is switched off.

6.19 Using the on-board computer

Notice

- ▶ Never use on-board computer, the display or the display mount as a handle. If the on-board computer, display or display mount are used to lift the pedelec, components can become irreparably damaged.

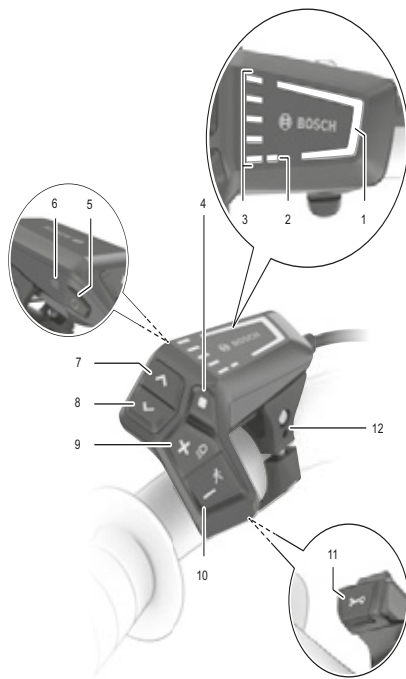

Figure 170: Overview of BOSCH LED Remote on-board computer

	Symbol	Designation
1		Selected level of assistance indicator
2		ABS indicator (optional)
3		Battery level indicator (on-board computer)
4	◆	Select button
5	⏻	On-Off button (on-board computer)
6		Ambient light sensor

Table 70: Overview for on-board computer

	Symbol	Designation
7	>	Increase brightness button/ forward button
8	<	Decrease brightness button/ back button
9	+	Plus button/ light button
10	-	Minus button/ push assist button
11		Diagnosis connection (for maintenance purposes only)
12		Mount

Table 70: Overview for on-board computer

6.19.1 Using the diagnosis port

Notice

A USB connection is not a waterproof plug connection. Any moisture penetrating through the USB port may trigger a short circuit in the on-board computer.

- ▶ Never connect an external device.
- ▶ Regularly check the position of the rubber cover on the USB port and adjust it as necessary.

The diagnosis connection is only designed for maintenance purposes and is not suitable for connecting external devices.

- ▶ Keep the diagnosis port flap closed at all times to ensure no dust or moisture can penetrate through the port.

6.19.2 Charging the on-board computer battery

If both the charge level in the battery and the on-board computer's internal battery are low, the on-board computer battery can be charged via the diagnosis port.

- ▶ Connect the internal battery to a power bank or another suitable power source with a USB type C® cable. (charge voltage: 5 V; charging current: max. 600 mA).

6.19.3 Using the riding light

- ✓ The drive system needs to be already switched on to turn on the *riding light*.



Figure 171: Position of riding light button (1)

- ▶ Press the **light button for more than 1 second**.
- ⇒ The front light and rear light are both switched on (*riding light symbol* is displayed) and switched off (*Riding light symbol* is switched off) at the same time.

6.19.4 Setting the brightness of indicators

The ambient light sensor regulates the indicator brightness.

- ✓ The ambient light sensor must be clean and must not be covered.



Figure 172: Position of increase brightness button (2) and decrease brightness button (1)

- ▶ Press the **increase brightness button** and **decrease brightness button** to set the brightness of the indicator LEDs.

6.19.5 Using the push assist system



Injury from pedals or wheels

The pedals and the drive wheel turn when the push assist system is used. There is a risk of injury if the pedelec wheels are not in contact with the ground when the push assist system is used (e.g. when carrying the pedelec up stairs or when placing it on a bicycle rack).

- ▶ Only use the push assist mode when pushing the pedelec.
- ▶ You must steer the pedelec securely with both hands when using push assist.
- ▶ Allow for enough freedom of movement for the pedals.

The push assist helps move the pedelec. The push assist system speed depends on the selected gear. The lower the selected gear is, the lower the speed in the push assist function is (at full power). The maximum speed is 6 km/h.

- ✓ We recommend using first gear for cycling uphill to protect the drive.



Figure 173: Position of push assist button (1)

- 1 Press **Push assist button** for longer than 1 seconds. Hold down the button.
 - ⇒ The battery level indicator goes out and a white running light in the direction of travel indicates push assist is ready.
- 2 One of the following actions must be taken within the next 10 seconds:
 - ▶ Push pedelec forwards.
 - ▶ Push pedelec backwards.
 - ▶ Make a weaving movement with the pedelec.
 - ⇒ The push assist is activated. The continuous white bars change colour to ice blue.
 - ⇒ The motor starts to push.
- 3 Release **push assist button** on the on-board computer to switch off motor assistance.
- 4 Push the **push assist button within 10 seconds to reactivate motor assistance.**
- 5 If motor assistance deactivates within 10 seconds, the push assist function switches off automatically.

Push assist will also switch off automatically if

- the rear wheel blocks
- speed bumps cannot be ridden over
- a part of the body is blocking the bicycle crank
- an obstacle turns the crank further
- the rider pedals
- the **plus button** or **On-Off button** is pressed.

The push assist mode of operation is subject to country-specific regulations and may therefore differ from the above description or may be deactivated.

6.19.6 Selecting the level of assistance

The on-board computer is used to configure to what extent the electric drive should assist the rider when pedalling. You can change the level of assistance at any time while you are cycling.



Figure 174: Position of plus and minus buttons

- ▶ Press the **plus button** (2) on the on-board computer to increase the level of assistance.
- ▶ Press the **minus button** (1) on the on-board computer to reduce the level of assistance.
- ⇒ The motor power used is displayed in colour in the level of assistance indicator.

If the system is switched off, the level of assistance last displayed is saved.

6.20 Brake

WARNING

Crash caused by brake failure

Oil or lubricant on the brake disc in a disc brake or on the rim of a rim brake can cause the brake to fail completely. This may cause a crash with serious injuries.

- ▶ Never allow oil or lubricant to come into contact with the brake disc or brake linings or on the rim of a rim brake.
- ▶ If the brake linings have come into contact with oil or lubricant, contact specialist dealer to have the components cleaned or replaced.

If the brakes are applied continuously for a long time (e.g. while riding downhill for a long time), the fluid in the brake system may heat up. This may create a vapour bubble. This will cause air bubbles or water contained in the brake system to expand. This may suddenly make the lever travel wider. This may cause a crash with serious injuries.

- ▶ Release the brake regularly when riding downhill for a longer period of time.
- ▶ Use the front and rear wheel brakes alternately.

The motor drive force is shut off during the ride as soon as the rider no longer is no longer pedalling. The drive system does not switch off when braking.

- ▶ In order to achieve optimum braking results, do not pedal while braking.

6.20.1 Using the brake lever

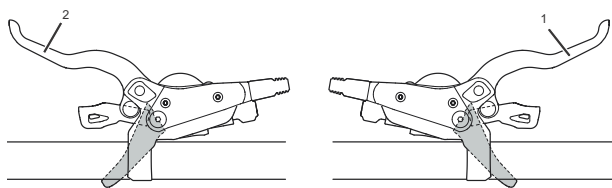

Figure 175: Front (2) and rear (1) brake lever – Shimano brake used as an example

- ▶ Push the left *brake lever* to apply the front wheel brake.
- ▶ Pull the right-hand brake lever to apply the rear wheel brake.

6.21 Gear shift

The selection of the appropriate gear is a prerequisite for a physically comfortable ride and making sure that the electric drive system functions properly. The ideal pedalling frequency is between 70 and 80 revolutions per minute.

- ▶ Stop pedalling briefly when changing gears. This makes it easier to switch gears and reduces wear on the drivetrain.

6.21.1 Using the derailleur gears

The speed and range can be increased while applying the same force if you select the right gear.

- ✓ Stop pedalling briefly when changing gears. This makes it easier to switch gears and reduces wear on the drivetrain. However, keep the crank moving while switching gears.

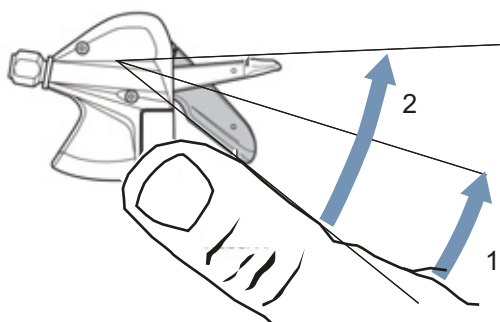

Figure 176: Switching gears with lever A, using gear shift SL-M315 as an example

Lever A switches from a smaller pinion to a larger one. The number of pinions switched depends on the selected position of lever A.

- ▶ Place shifter A in position 1.
- ⇒ System shifts one pinion higher.
- ▶ Place shifter A in position 2.
- ⇒ System shifts two pinions higher.

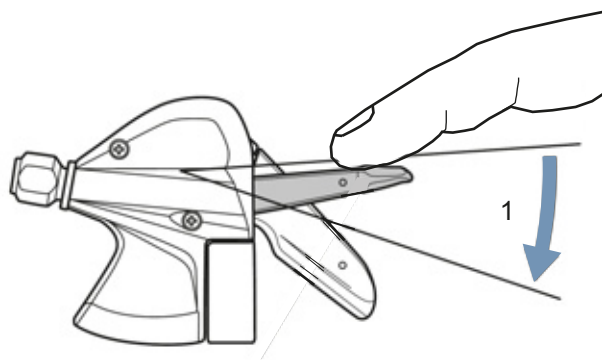

Figure 177: Switching gears with lever B, using gear shift SL-M315 as an example

Lever B switches from a larger pinion to a smaller one.

- ▶ Place shifter B in position 1.
- ⇒ System shifts one pinion lower.

Switching gears

- ▶ Select the appropriate gear with the gear shift unit.
- ⇒ The gear shift switches gear.
- ⇒ The shifter returns to its original position.
- ▶ Clean and lubricate the rear derailleur if gear changes block.

6.22 Parking

Notice

Heat or direct sunlight can cause the *tyre pressure* to increase above the permitted maximum pressure. This can destroy the *tyres*.

- ▶ Never park the pedelec in the sun.
- ▶ On hot days, regularly check the *tyre pressure* and adjust it as necessary.

Moisture penetrating at low temperatures may impair individual functions due to the open structural design.

- ▶ Always keep the pedelec dry and free from frost.
- ▶ If the pedelec is used at temperatures below 3 °C, the specialist dealer must perform maintenance beforehand and prepare it for winter use.

The pedelec's force of weight may cause the kickstand to sink into soft ground, possibly causing the pedelec to topple over as a result.

- ▶ The pedelec must be parked on firm, level ground only.

- 1 Switch off drive system (see Section 6.18.2).
- 2 After getting off, use your foot to lower the kickstand completely before parking. Ensure that it is stable.
- 3 Park the pedelec carefully and check that it is stable.
- 4 Protect saddle with saddle cover if you park the pedelec outside.
- 5 Lock the pedelec with the bicycle lock.
- 6 Remove battery to protect against theft (see Section 6.17.1).
- 7 Clean and service pedelec after every ride; see Section 7.2.

Checklist after each ride

Cleaning		
<input type="checkbox"/>	Lights and reflectors	See Section 7.2.5
<input type="checkbox"/>	Brake	See Section 7.2.5
<input type="checkbox"/>	Suspension fork	See Section 7.2.1
<input type="checkbox"/>	Suspension seat post	See Section 7.2.6
<input type="checkbox"/>	Rear frame damper	See Section 7.2.7
<input type="checkbox"/>	Pedal	See Section 7.2.4
Care		
<input type="checkbox"/>	Suspension fork	See Section 3

6.22.1 Screwing in the quickly adjustable stem

Only applies to pedelecs with this equipment

Screw in the quickly adjustable stem to save space when parking

- 1 Open stem clamping lever.

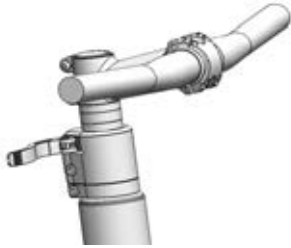

Figure 178: Example of All Up with open stem clamping lever

- 2 Pull handlebars into highest possible position.

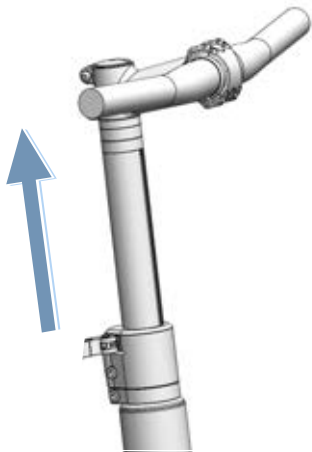

Figure 179: Example of All Up pulled into highest possible position

- 3 Turn handlebars 90° in a clockwise direction.

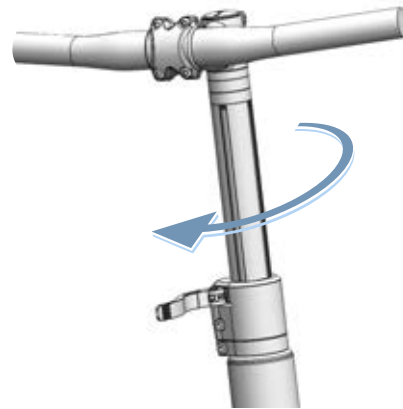

Figure 180: Example of All Up screwed in

- 4 Place handlebars at required height.
- 5 Close stem clamping lever.

6.22.2 Activating the lock function

Only applies to pedelecs with this equipment

- ▶ Remove the on-board computer used during set-up.
- ⇒ The lock function is activated. The drive system now provides no assistance. However, the rider can continue to use the pedelec without assistance.
- ⇒ The drive unit will emit a lock sound (an audible signal) as long as the drive system is switched on.
- ⇒ The lock function status is displayed with a lock icon on the on-board computer for around 3 seconds.

7 Cleaning, servicing and inspection

- Clean, maintain and inspect pedelec as indicated on checklists.
Complying with these cleaning instructions can increase operational reliability, reduce wear on components, extend the service life of components and ensure safety.

Checklist: Before each ride		
<input type="checkbox"/>	Check everything is sufficiently clean	See Section 7.2
<input type="checkbox"/>	Check guards	See Section 7.1.1
<input type="checkbox"/>	Check battery to ensure it is firmly in place	See Section 6.17
<input type="checkbox"/>	Check lights	See Section 7.1.13
<input type="checkbox"/>	Check brake	See Section 7.1.14
<input type="checkbox"/>	Check suspension seat post	See Section 7.1.9
<input type="checkbox"/>	Check pannier rack	See Section 7.1.5
<input type="checkbox"/>	Check bell	See Section 7.1.10
<input type="checkbox"/>	Check handles	See Section 7.1.11
<input type="checkbox"/>	Check rear frame damper	See Section 7.1.4
<input type="checkbox"/>	Check wheel concentricity	See Section 7.1.7
<input type="checkbox"/>	Check frame	See Section 7.1.2
<input type="checkbox"/>	Check quick releases	See Section 7.1.8
<input type="checkbox"/>	Check guards	See Section 7.1.6
<input type="checkbox"/>	Check USB cover	See Section 7.1.12

Checklist: After each ride		
<input type="checkbox"/>	Clean lights	See Section 7.2.1
<input type="checkbox"/>	Clean reflectors	See Section 7.2.1
<input type="checkbox"/>	Clean brake	See Section 7.2.5
<input type="checkbox"/>	Clean suspension fork	See Section 7.2.2
<input type="checkbox"/>	Maintain suspension fork	See Section 3
<input type="checkbox"/>	Clean suspension seat post	See Section 7.2.6
<input type="checkbox"/>	Clean rear frame damper	See Section 7.2.7
<input type="checkbox"/>	Clean the pedals	See Section 7.2.4

Checklist: weekly tasks		
	Clean chain	See Section 7.3.18
	City, folding, cargo and children's bikes and bicycles for young adults	When dry: every 10 days In wet conditions: every 2–6 days
<input type="checkbox"/>	Trekking and racing bikes	When dry: every 140... 200 km In wet conditions: every 100 km
	Mountain bikes	When dry: every 60... 100 km In wet conditions: after every ride
<input type="checkbox"/>	Belt (every 250–300 km)	See Section 7.3.17
	Servicing the chain	see Section 7.4.16 and 7.4.16.1
	City, folding, cargo and children's bikes and bicycles for young adults	When dry: every 10 days In wet conditions: every 2... 6 days
<input type="checkbox"/>	Trekking and racing bikes	When dry: every 140... 200 km In wet conditions: every 100 km
	Mountain bikes	When dry: every 60... 100 km In wet conditions: maintain all the time
<input type="checkbox"/>	Maintain all-round chain guard.	See Section 7.4.16.1
<input type="checkbox"/>	Check tyre pressure (at least once a week)	See Section 7.5.1.1
<input type="checkbox"/>	Check tyres (every 10 days)	See Section 7.5.1.2
<input type="checkbox"/>	Eightpins seat post Refill oil (every 20 hours)	See Section 7.4.19

Checklist: monthly tasks		
<input type="checkbox"/>	Cleaning the battery	See Section 7.3.2
<input type="checkbox"/>	Clean on-board computer	See Section 7.3.1
<input type="checkbox"/>	Clean on-board computer	See Section 7.3.1
<input type="checkbox"/>	Check disc brake linings (once a month or after braking 1,000 times)	See Section 7.5.2.4
<input type="checkbox"/>	Check rim brake brake linings (once a month or after braking 3000 times)	See Section 7.5.1.3
<input type="checkbox"/>	Checking the rim braking surface for wear	See Section 7.5.2.6
<input type="checkbox"/>	Clean handbrake	See Section 7.3.15.1
<input type="checkbox"/>	Clean brake disc	See Section 7.3.16
<input type="checkbox"/>	Check brake disc	See Section 7.5.2.4
<input type="checkbox"/>	Check brake Bowden cables	See Section 7.5.2.3
<input type="checkbox"/>	Clean pannier rack	See Section 7.3.4
<input type="checkbox"/>	Clean handles	See Section 7.3.7
<input type="checkbox"/>	Maintain handles	See Section 7.4.8
<input type="checkbox"/>	Check handbrake	See Section 7.5.2.1
<input type="checkbox"/>	Check hydraulic system	See Section 7.5.2.2
<input type="checkbox"/>	Clean cassette	See Section 7.3.14
<input type="checkbox"/>	Clean chain and all-round chain guard	See Section 7.3.18.1
<input type="checkbox"/>	Clean chain wheels	See Section 7.3.14
<input type="checkbox"/>	Clean leather handles	See Section 7.3.7.1
<input type="checkbox"/>	Maintain leather handles	See Section 7.4.8.2
<input type="checkbox"/>	Clean the leather saddle	See Section 7.3.9.1
<input type="checkbox"/>	Maintain leather saddle	See Section 7.4.11
<input type="checkbox"/>	Clean handlebars	See Section 7.3.6

Checklist: monthly tasks		
<input type="checkbox"/>	Cleaning the motor	See Section 7.3.3
<input type="checkbox"/>	Clean hub	See Section 7.3.12
<input type="checkbox"/>	Cleaning the frame	See Section 7.3.4
<input type="checkbox"/>	Clean tyres	See Section 7.3.10
<input type="checkbox"/>	Check back-pedal brake	See Section 7.5.2.5
<input type="checkbox"/>	Clean saddle	See Section 7.3.9
<input type="checkbox"/>	Clean seat post	See Section 7.3.8
<input type="checkbox"/>	Maintain seat post	See Section 7.4.9
<input type="checkbox"/>	Clean shifter	See Section 7.3.13.1
<input type="checkbox"/>	Cleaning gear shift	See Section 7.3.13
<input type="checkbox"/>	Clean shift cables	See Section 7.3.13
<input type="checkbox"/>	Check disc brake	See Section 7.5.2.4
<input type="checkbox"/>	Clean mudguard	See Section 7.3.4
<input type="checkbox"/>	Clean kickstand	See Section 7.3.4
<input type="checkbox"/>	Clean spokes and spoke nipples	See Section 7.3.11
<input type="checkbox"/>	Maintain spoke nipples	See Section 7.4.13
<input type="checkbox"/>	Clean rigid fork	See Section 7.3.4
<input type="checkbox"/>	Clean transmission	See Section 7.3.13
<input type="checkbox"/>	Clean front derailleur	See Section 7.3.14
<input type="checkbox"/>	Clean stem	See Section 7.3.5

Checklist for tasks every three months		
<input type="checkbox"/>	Check brake pressure point	See Section 7.5.2.1
<input type="checkbox"/>	Check rim brake (100 hours trip time or every 2,000 km)	See Section 7.5.2.6
<input type="checkbox"/>	Checking the spokes	See Section 7.5.1.3

Checklist: Tasks performed at least every six months (or every 1,000 km)	
<input type="checkbox"/>	Check Bowden cables gear shift See Section 7.5.15.2
<input type="checkbox"/>	Maintain handbrake See Section 7.4.18.1
<input type="checkbox"/>	Maintain carbon seat post See Section 7.4.9.2
<input type="checkbox"/>	Check gear shift electric cables See Section 7.5.15.1
<input type="checkbox"/>	Maintain suspension seat post See Section 7.4.9.1
<input type="checkbox"/>	Maintain rims See Section 7.4.10
<input type="checkbox"/>	Check rims See Section 7.5.1.3
<input type="checkbox"/>	Check rim hooks See Section 7.5.1.3
<input type="checkbox"/>	Maintain fork See Section 7.4.2
<input type="checkbox"/>	Check gear shift See Section 7.5.15
<input type="checkbox"/>	Maintain pannier rack See Section 7.4.3
<input type="checkbox"/>	Check chain See Section 7.5.14.1
<input type="checkbox"/>	Check derailleur gears See Section 7.5.14.1 and 7.5.15.3
<input type="checkbox"/>	Check chain tension See Section 7.5.4.1 and 7.5.4.2
<input type="checkbox"/>	Check wheel See Section 7.5.1
<input type="checkbox"/>	Maintain handlebars See Section 7.4.7
<input type="checkbox"/>	Check handlebars See Section 7.5.12
<input type="checkbox"/>	Check light See Section 7.5.10
<input type="checkbox"/>	Maintain hub See Section 7.4.12
<input type="checkbox"/>	Check hub See Section 7.5.14.2
<input type="checkbox"/>	Check nipple holes See Section 7.5.1.4
<input type="checkbox"/>	Maintain pedals See Section 7.4.15
<input type="checkbox"/>	Check pedal. See Section 7.5.14
<input type="checkbox"/>	Maintain frame See Section 7.4.1
<input type="checkbox"/>	Check belt tension See Section 7.5.9
<input type="checkbox"/>	Check saddle See Section 7.5.13
<input type="checkbox"/>	Maintain shifter See Section 7.4.14.2
<input type="checkbox"/>	Maintain rear derailleur articulated shaft See Section 7.4.14.1
<input type="checkbox"/>	Maintain rear derailleur jockey wheels See Section 7.4.14.1
<input type="checkbox"/>	Maintain kickstand See Section 7.4.5
<input type="checkbox"/>	Check kickstand stability See Section 7.5.19

Checklist: Tasks performed at least every six months (or every 1,000 km)	
<input type="checkbox"/>	Check steering headset See Section 8.5.6
<input type="checkbox"/>	Servicing the stem See Section 7.4.6
<input type="checkbox"/>	Checking the stem See Section 7.5.11

Checklist: Annual tasks (or every 2000 km)	
<input type="checkbox"/>	Adjust hub with cone bearing See Section 8.5.6
<input type="checkbox"/>	Check nipple well (every 1,000 hours or every 2,000 km) See Section 7.5.1.5

WARNING
Crash caused by brake failure

Oil or lubricant on the brake disc in a disc brake or on the rim of a rim brake can cause the brake to fail completely. This may cause a crash with serious injuries.

- ▶ Never allow oil or lubricant to come into contact with the brake disc or brake linings or on the rim of a rim brake.
- ▶ If the brake linings have come into contact with oil or lubricant, contact specialist dealer to have the components cleaned or replaced.
- ▶ After cleaning, servicing or repair, carry out a few test brake applications.

The brake system is not designed for use on a pedelec which is placed on its side or turned upside down. The brake may not function correctly as a result. This can cause a crash, which may result in injuries.

- ▶ If pedelec has been placed on its side or turned upside down, apply the brakes a couple of times before setting off to ensure they work as normal..

The brake seals are unable to withstand high pressures. Damaged brakes can fail and cause an accident with injury.

- ▶ Never clean the pedelec with a pressure washer or compressed air.

Take great care when using a hosepipe. Never point the water jet directly at the seal section.

CAUTION
Crash and falling caused by unintentional activation

There is a risk of injury if the electric drive system is activated unintentionally.

- ▶ Remove the battery before cleaning.

Notice

Water may enter the inside of the bearings if you use a steam jet. This dilutes the lubricant inside, the friction increases and, as a result, the bearings are permanently damaged in the long term. Water may also penetrate the electric components and damage them permanently.

- ▶ Never clean pedelec with a pressure washer, water jet or compressed air.

Greased parts, such as the seat post, the handlebars or the stem, may no longer be safely and reliably clamped.

- ▶ Never apply grease or oil to parts which are clamped

Harsh cleaning agents such as acetone, methylene and trichloroethylene and solvents such as thinners, alcohol and corrosion protection can attack pedelec components and damage them permanently.

- ▶ Use approved care and cleaning products only.

7.1 Before each ride

Complying with these cleaning instructions is the only way to reduce wear on components, increase the operating hours and guarantee safety.

7.1.1 Checking the guards

The chain or belt guards, mudguards or the motor cover may break and fall off when the pedelec is transported or parked outside.

- ▶ Check that all guards are in place.
- ▶ Take pedelec out of service if a guard is damaged or missing. Contact specialist dealer.

7.1.2 Checking the frame

- ▶ Check frame for cracks, warping and damage to the paintwork.
- ▶ If there are any cracks, warping or damage to the paintwork, remove the pedelec from service. Contact specialist dealer.

7.1.3 Checking the fork

- ▶ Check fork for cracks, warping, tarnished components, leaked oil and damage to the paintwork. Also look at hidden parts on the underside.
- ⇒ If there are any cracks, warping, tarnished components, leaked oil or damage to the paintwork, remove the pedelec from service. Contact specialist dealer.

7.1.4 Checking the rear frame damper

- ▶ Check rear frame damper for cracks, warping, tarnished components, leaked oil and damage to the paintwork. Also look at hidden parts on the underside.
- ⇒ If there are any cracks, warping, tarnished components, leaked oil or damage to the paintwork, remove the pedelec from service. Contact specialist dealer.

7.1.5 Checking the pannier rack

- 1 Hold onto pedelec by its frame. Hold onto pannier rack with the other hand.
- 2 Move the pannier rack backwards and forwards to check that all screw connections are firmly in place.
 - ⇒ Tighten loose screws.
 - ⇒ Attach loose baskets permanently with a basket bracket or cable ties.

7.1.6 Checking the mudguards

- 1 Hold onto pedelec by its frame. Hold onto mudguard rack with the other hand.
- 2 Move the mudguard backwards and forwards to check that all screw connections are firmly in place.
 - ⇒ Tighten loose screws.

7.1.7 Check wheel concentricity

- ▶ Lift the front and rear wheels one after the other and spin each wheel when lifted.
- ⇒ If the wheel is loose or crooked when it turns, take pedelec out of service. Contact specialist dealer.

7.1.8 Checking the quick releases

- ▶ Check quick releases to ensure that all quick releases are firmly in their fully closed end position.
- ⇒ If a quick release is not firmly in its closed end position, open quick release and place in its end position.
- ⇒ If the quick release cannot be firmly placed in its end position, take pedelec out of service. Contact specialist dealer.

7.1.9 Checking the suspension seat post

- ▶ Deflect and let the suspension seat post rebound.
- ⇒ If you hear unusual noises when the suspension seat post deflects and rebounds, or it yields without any resistance, take pedelec out of service. Contact specialist dealer.

7.1.10 Checking the bell

- 1 Press the bell button downwards.
 - 2 Let button spring back.
- ⇒ If you do not hear a clear, distinct ring of the bell, replace bell. Contact specialist dealer.

7.1.11 Checking the handles

- ▶ Check the handles are firmly in place.
- ⇒ Screw loose handles firmly into place.

7.1.12 Checking the USB cover

- ⇒ If featured, check the position of the *cover on the USB port* on a regular basis and adjust if necessary.

7.1.13 Checking the riding light

- 1 Switch light on.
 - 2 Check that the headlight and rear light come on.
- ⇒ If the headlight and rear lights do not come on, take pedelec out of service. Contact specialist dealer.

7.1.14 Checking the brake

- 1 Pull both handbrakes when stationary.
 - 2 Push the pedals.
- ⇒ If no resistance is generated in the handbrake's usual position, take pedelec out of service. Contact specialist dealer.
 - ⇒ If the brake is losing fluid, take pedelec out of service. Contact specialist dealer.

7.2 After each ride

Complying with these cleaning instructions is the only way to reduce wear on components, increase the operating hours and guarantee safety.

The following items should be ready for use to clean the pedelec after each ride:









Tool		Cleaning agent	
 Cloth	 Bucket	 Water	 Dish-washing liquid
 Brush	 Fork oil	 Silicone or Teflon oil	 Acid-free lubricating grease

Table 71: Required tools and cleaning agents after each ride

7.2.1 Cleaning the riding light and reflectors



- 1 Clean headlight, rear light and reflectors with a damp cloth.

7.2.2 Cleaning the suspension fork



- 1 Remove dirt and deposits from the stanchions and deflector seals with a damp cloth. Check the stanchions for dents, scratches, staining or leaking oil.
- 2 Lubricate the dust seals and stanchions with a few drops of silicone spray.
- 3 Maintain the suspension fork after cleaning.

7.2.3 Maintaining the suspension fork



- Treat dust seals with fork oil.

7.2.4 Cleaning the pedals



- Clean pedals with a brush and soapy water.

7.2.5 Cleaning the brake



- Clean dirt on the rim and brake components with a slightly dampened cloth.

7.2.6 Cleaning the suspension seat post



- Clean dirt on the articulated joints with a slightly dampened cloth immediately after a ride.

7.2.7 Cleaning the rear frame damper



- Clean dirt on the articulated joints with a slightly dampened cloth immediately after a ride.

7.3 Basic cleaning

Complying with these basic cleaning instructions is the only way to reduce wear on components, increase the operating hours and guarantee safety.

The following are required for basic cleaning:

Tool		Cleaning agent	
 Gloves	 Toothbrush	 Water	 Lubricant
 Cloth	 Paintbrush	 Dish-washing liquid	 Brake cleaner
 Sponge	 Watering can	 Degreaser	 Leather cleaner
 Brushes	 Bucket		

Table 72: Required tools and cleaning agents for basic cleaning

- ✓ Remove battery and on-board computer before thorough cleaning.

7.3.1 Clean on-board computer and control panel



Notice

If water enters the on-board computer, it will be permanently damaged.

- ▶ Never immerse the on-board computer in water.
 - ▶ Never use a cleaning agent.
-
- ▶ Carefully clean the on-board computer and control panel with a soft, damp cloth.

7.3.2 Cleaning the battery



CAUTION

Risk of fire and explosion due to penetration by water

The battery is only protected from simple spray water. Penetration by water can cause a short circuit. The battery may self-ignite and explode.

- ▶ Keep contacts dry and clean.
- ▶ Never immerse the battery in water.

Notice

- ▶ Never use a cleaning agent.

- 1 Clean the battery electrical connections with a dry cloth or paintbrush only.
- 2 Wipe off the decorative sides with a damp cloth.

7.3.3 Cleaning the motor



Notice

If water enters the motor, it will be permanently damaged.

- ▶ Never open the motor.
 - ▶ Never immerse the motor in water.
 - ▶ Never use cleaning agents.
-
- ▶ Carefully clean the motor on the outside with a soft, damp cloth.

7.3.4 Clean Frame, fork, pannier rack, guards and kickstand



- 1 Soak the components with dish-washing detergent if the dirt is thick and ingrained.
- 2 After leaving it to soak for a short time, remove the dirt and mud with a sponge, brush and toothbrushes.
- 3 Rinse off the components with water from a watering can.
- 4 Wipe away oil stains with a degreaser.

7.3.5 Cleaning the stem



- 1 Clean stem with a cloth and soapy water.
- 2 Rinse off component with water from a watering can.

7.3.6 Cleaning the handlebars



- 1 Clean handlebars, including handles and all gears or twist grips, with a cloth and soapy water.
- 2 Rinse off component with water from a watering can.

7.3.7 Clean handles



- 1 Clean handles with sponge, water and soapy water.
- 2 Rinse off component with water from a watering can.
- 3 Care for rubber handles after cleaning (see Section [7.4.8](#)).

7.3.7.1 Cleaning leather handles



Leather is a natural product and has similar properties to human skin. Regular cleaning and care help to prevent leather dehydrating, fading or becoming brittle or stained.

- 1 Remove dirt with a soft, damp cloth.
- 2 Remove stubborn stains with a leather cleaner.
- 3 Care for leather handles after cleaning (see Section [7.4.8.2](#)).

7.3.8 Cleaning the seat post



- 1 Clean seat post with a cloth and soapy water.
- 2 Rinse off component with water from a watering can.
- 3 Wipe away any grease or assembly paste residue with a cloth and degreaser.

7.3.9 Cleaning the saddle



- 1 Clean the saddle with lukewarm water and a cloth dampened with soapy water.
- 2 Rinse off component with water from a watering can.

7.3.9.1 Cleaning the leather saddle

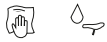

Leather is a natural product and has similar properties to human skin. Regular cleaning and care help to prevent leather dehydrating, fading or becoming brittle or stained.

- 1 Remove dirt with a soft, damp cloth.
- 2 Remove stubborn stains with a leather cleaner.
- 3 Care for leather saddle after cleaning (see Section [7.4.11](#)).

7.3.10 Cleaning the tyres



- 1 Clean tyres with a sponge, a brush and soap cleaner.
- 2 Rinse off component with water from a watering can.
- 3 Remove any embedded chips and small stones.

7.3.11 Cleaning the spokes and spoke nipples

- 1 Clean spokes from the inside to the outside with a sponge, brush and soapy water.
- 2 Clean rim with a sponge.
- 3 Rinse off component with water from a watering can.
- 4 Care for spoke nipples after cleaning (see Section [7.4.13](#)).

7.3.12 Clean hub



- 1 Put on protective gloves.
- 2 Remove dirt from hub with a sponge and soapy water.
- 3 Rinse off component with water from a watering can.
- 4 Wipe off oily dirt with a degreaser and a cloth.

7.3.13 Cleaning the switching elements



- 1 Clean gear shift and shift cables with water, a brush and dish-washing detergent.
- 2 Rinse off component with water from a watering can.

7.3.13.1 Cleaning the shifter



- Carefully clean shifter with a damp, soft cloth.

7.3.14 Clean cassette, chain wheels and front derailleur



- 1 Put on protective gloves.
- 2 Spray cassette, chain wheels and front derailleur with degreasing agent.
- 3 Clean coarse dirt with a brush after soaking for a short time.
- 4 Wash down all parts with dish-washing detergent and a toothbrush.
- 5 Rinse off component with water from a watering can.

7.3.15 Clean brake

7.3.15.1 Clean handbrake



- ▶ Carefully clean the handbrake with a damp, soft cloth.

7.3.16 Cleaning the brake disc



Notice

- ▶ Protect brake disc against lubricants and grease from hands.

- 1 Put on protective gloves.
- 2 Spray brake disc with brake disc cleaning spray.
- 3 Wipe with a cloth.

7.3.17 Cleaning the belt



Notice

- ▶ Never use aggressive (acid-based) cleaners, rust removers or degreasers when cleaning the belt.

- 1 Dampen a cloth with soapy water. Place the cloth on the belt.
- 2 Hold and apply slight pressure while slowly turning the rear wheel so that the belt passes through the cloth.

7.3.18 Cleaning the chain



Notice

- ▶ Never use aggressive (acid-based) cleaners, rust removers or degreasers when cleaning the chain.
- ▶ Never use gun oil or rust remover spray.
- ▶ Never use chain cleaning devices or chain cleaning baths.
- ▶ Have chain with all-round guard cleaned and cared for during major inspection.

- ✓ Place newspaper or paper towels underneath to collect dirt.

- 1 Slightly dampen a brush with dish-washing liquid. Brush both sides of the chain.
- 2 Dampen a cloth with soapy water. Place the cloth on the chain.
- 3 Hold and apply slight pressure while slowly turning the rear wheel, so the chain passes through the cloth.
- 4 Wipe off oily, dirty chains thoroughly with a cloth and degreaser.
- 5 Care for the chain after cleaning (see Section [7.4.16](#)).

7.3.18.1 Clean chain, including all-round chain guard



Notice

The chain guard must be removed before cleaning. Contact specialist dealer.

- ▶ Clean water hole on the chain guard lower surface.
- ▶ Care for the chain after cleaning (see Section [7.4.16.1](#)).

7.4 Maintenance

Complying with these servicing instructions is the only way to reduce wear on components, increase the operating hours and guarantee safety.

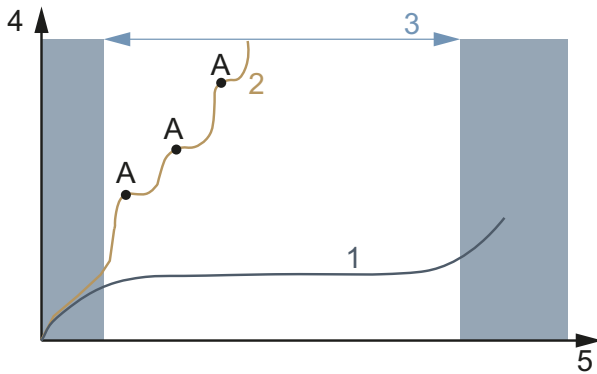

Figure 181: Diagram showing wear, operating hours (x) vs. material erosion (y)

The service life (3) of an optimally serviced drive chain (1) is almost three times as long with lubrication (A) compared to a drive chain (2) lubricated on an irregular basis.

These tools and cleaning agents are required for servicing:











Tool		Cleaning agent	
 Cloth	 Toothbrush	 Frame wax spray	 Silicone or Teflon oil
		 Acid-free lubricating grease	 Fork oil
		 Teflon spray	 Spray oil
		 Chain oil	 Leather care product
		 Battery terminal grease	

Table 73: Required tools and cleaning agents for servicing

7.4.1 Maintain frame



Notice

- ▶ Hard wax polish and protection wax are particularly resistant on gloss paintwork. These car accessory retail products are unsuitable for matt paint finishes.
- ▶ Try wax spray out on a small spot before application.

- 1 Dry frame with a cloth.
- 2 Spray frame with spray wax and leave to dry.
- 3 Wipe away any wax residue with a cloth.

7.4.2 Maintain fork



Notice

- ▶ Hard wax polish and protection wax are particularly resistant on gloss paintwork. These car accessory retail products are unsuitable for matt paint finishes.
- ▶ Try wax spray out on a small spot before application.

- 1 Dry fork with a cloth.
- 2 Spray frame care oil on frame and leave to dry.
- 3 Wipe away any wax residue with a cloth.

7.4.3 Maintain pannier rack

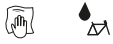

- 1 Dry pannier rack with a cloth.
- 2 Spray pannier rack with spray wax and leave to dry.
- 3 Wipe pannier rack with a cloth.
- 4 Protect chafing points on panniers with adhesive film. Replace worn adhesive film.
- 5 Maintain coil springs with silicone spray or wax spray from time to time.

7.4.4 Maintain mudguard



- ▶ Depending on the requirements for the material in the mudguard, apply hard wax polish, metal polish or a plastic care product as per the product instructions.

7.4.5 Servicing the kickstand



- 1 Dry kickstand with a cloth.
- 2 Spray kickstand rack with spray wax and leave to dry.
- 3 Wipe down kickstand with a cloth.
- 4 Lubricate the kickstand joints with spray oil.

7.4.6 Maintaining the stem



- 1 Spray painted and polished metal surfaces with wax spray and leave to dry.
- 2 Wipe away any wax residue with a cloth.
- 3 Apply silicone or Teflon oil to the stem shaft tube and the quick release lever pivot point with a cloth.

- 4 If you have a Speedlifter Twist, also apply oil to the unlocking bolt groove in the Speedlifter body.
- 5 Apply a little acid-free lubricant grease between the stem quick release lever and the sliding piece to reduce the quick release lever operating force.
- 6 If you have a stem with a cone clamp, apply a new protective layer of assembly paste onto the stem and fork steerer contact point once a year.

7.4.7 Maintaining the handlebars



- 1 Spray painted and polished metal surfaces with wax spray and leave to dry.
- 2 Wipe away any wax residue with a cloth.

7.4.8 Maintaining the handles

7.4.8.1 Maintaining the rubber handles

- 1 Apply talcum powder to sticky rubber handles.

Notice

- ▶ Never apply talcum powder to leather or foam handles.

7.4.8.2 Maintaining the leather handles



Standard leather care products keep leather smooth and resistant, brighten its appearance and improve or replace stain protection.

- 1 Try leather care product out on a less visible spot before use.
- 2 Care for leather handles with a leather care product.

7.4.9 Maintaining the seat post

- 1 Carefully preserve screw connections with wax spray. In doing so, ensure that no wax is applied to the metal contact surfaces.
- 2 Replace the assembly paste protective layer on the metal contact surfaces on the seat post and seat tube every year.

7.4.9.1 Maintaining the suspension seat post



- 1 Lubricate articulated joints with spray oil.
- 2 Deflect and let the suspension seat post rebound five times. Remove any surplus lubricant with a clean cloth.

7.4.9.2 Maintaining the carbon seat post



Notice

Rain and puddle water can cause contact corrosion if carbon seat posts are used in an aluminium frame without protective assembly paste. It may then take a great deal of force to remove the seat post. The carbon seat post may break as a result.

- 1 Take out the carbon seat post.
- 2 Remove old assembly paste with a cloth.
- 3 Apply new assembly paste with a cloth.
- 4 Re-insert the carbon seat post.

7.4.10 Maintaining the rims



- Care for chrome rims, stainless steel rims and polished aluminium with chrome or metal polish. Never maintain the brake surface with polish.

7.4.11 Maintaining the leather saddle



Standard leather care products keep leather smooth and resistant, brighten its appearance and improve or replace stain protection.

- 1 Try leather care product out on a less visible spot before use.
- 2 Care for leather saddle from below with a leather care product. Only maintain the top of leather saddles with a leather care product if they are badly worn and dried-out.
- 3 Avoid wearing light-coloured trousers after care due to staining.

7.4.12 Maintaining the hub



- 1 Apply wax spray especially around the spoke holes. In doing so, ensure that no wax is applied to brake parts.
- 2 Treat rubber seals with a cloth with one or two drops of silicone spray. Never use oil if you have disc brakes.

7.4.13 Maintaining the spoke nipples



- 1 Apply wax spray onto the spoke nipples from the rim side.
- 2 Treat heavily corroded spoke nipples with a drop of penetrating of special care oil.

7.4.14 Maintaining the gear shift

7.4.14.1 Maintaining the rear derailleur articulated shafts and jockey wheel



- ▶ Treat front and rear derailleur articulated shafts and jockey wheels with Teflon spray.

7.4.14.2 Maintaining the shifter



Notice

- ▶ Never treat shifters with degreaser or penetrating oil spray.
- ▶ Lubricate articulated joints and mechanical parts which are accessible from outside with a few drops of spray oil or precision mechanics oil.

7.4.15 Maintaining the pedals



- 1 Treat pedals with spray oil. In doing so, ensure that no lubricant is applied to the pedal surfaces.
- 2 Lubricate seals and mechanical parts sparingly with a few drops of oil.
- 3 Remove any surplus lubricant with a clean cloth.
- 4 Spray metal foot rests with silicone spray.

7.4.16 Maintaining the chain



- ✓ Place newspaper or paper towels underneath to collect chain oil.
- 1 Lift rear wheel.
 - 2 Turn the crank briskly in an anti-clockwise direction.
 - 3 Use slight finger pressure to the chain oil bottle to apply a wafer-thin thread of oil to the chain links. The faster the crank is turned, the thinner the threads of oil will be.



Figure 182: Lubricating the chain

- 4 Remove excessive chain oil with a cloth. If you apply too much oil, it will make the chain all the dirtier at a later point in time.
- 5 Leave chain oil to penetrate into the chain links for a few hours or overnight.

7.4.16.1 Maintaining the chain and all-round chain guard



- ✓ Place newspaper or paper towels underneath to collect chain oil.
- 1 Lift rear wheel.
- 2 Turn the crank briskly in an anti-clockwise direction.
- 3 Use slight finger pressure to the chain oil bottle to apply a wafer-thin thread of oil onto the chain links through the oil hole on the upper surface of the chain guard. The faster the crank is turned, the thinner the threads of oil will be.
- 4 Remove excessive chain oil with a cloth. If you apply too much oil, it will make the chain all the dirtier at a later point in time.
- 5 Leave chain oil to penetrate into the chain links for a few hours or overnight.

7.4.17 Maintaining the battery



- ▶ Grease plug terminals on the battery with terminal grease or contact spray from time to time.

7.4.18 Maintaining the brake

7.4.18.1 Maintaining the handbrake



Notice

- ▶ Never treat brake handbrake with degreaser or penetrating oil spray.
- ▶ Lubricate articulated joints and mechanical parts which are accessible from outside with a few drops of spray oil or precision mechanics oil.

7.4.19 Lubricating the Eightpins seat post tube

- ▶ Use a 2.5 ml syringe to carefully fill Eightpins Fluid V3 very slowly into the lubricating nipple on the outer tube.



Figure 183: Lubricating the Eightpins seat post

Notice

- ▶ Fill a maximum of 2.5 ml since otherwise the reservoir inside will overflow and the oil will spill into the frame.

7.5 Inspection

The following tools are required for an inspection:







	Gloves
	Ring spanners 8 mm, 9 mm, 10 mm, 13 mm, 14 mm and 15 mm
	Torque spanner Working range 5... 40 Nm
	by.schulz handlebars: TORX® bits: T50, T55, and T60
	Hex key 2 mm, 2.5 mm, 3 mm, 4 mm, 5 mm, 6 mm and 8 mm
	Phillips screwdriver
	Slotted-head screwdriver

Table 74: Tools required for inspection

7.5.1 Checking the wheel

- 1 Hold pedelec.
- 2 Hold onto the front or rear wheel and try to move the wheel sideways. In doing so, check to see if the wheel nuts or quick releases move.
 - ⇒ If the wheel moves or the wheel nut or quick release moves sideways, take pedelec out of service. Contact specialist dealer.
- 3 Lift pedelec slightly. Turn front or rear wheel. In doing so, check whether the wheel deflects sideways or outwards.
 - ⇒ If the wheel deflects sideways or outwards, take pedelec out of service. Contact specialist dealer.

7.5.1.1 Checking tyre pressure

Notice

If the tyre pressure is too low in the tyre, the tyre does not achieve its load bearing capacity. The tyre is not stable and may come off the rim.

If the tyre pressure is too high, the tyre may burst.

Tyres are wear parts and wear away due to fatigue, storage, environmental influences or mechanical impacts. Only optimum tyre pressure will guarantee greater safety, lower rolling resistance, effective protection against punctures and a longer service life.

Air loss

Even the most airtight tube will lose pressure on a continuous basis since the air pressures in a pedelec tyre are significantly higher and the wall thicknesses significantly finer than in a car tyre. Pressure loss of 1 bar per month can be regarded as normal. During this process, the pressure loss is significantly faster at high pressures and significantly slower at low pressures.

Checking tyre pressure

The permitted pressure range is indicated on the side of the tyre.



Figure 184: Tyre pressure specification in bar (1) and psi (2)

- ▶ Verify tyre pressure against the value noted in the pedelec pass every 10 days as a minimum.

Dunlop valve**Only applies to pedelecs with this equipment**

The tyre pressure cannot be measured on the simple Dunlop valve. You thus measure the tyre pressure in the filling hose while slowly pumping the bicycle air pump.

- ✓ It is recommendable to use a bicycle air pump with a pressure gauge.
 - 1 Unscrew and remove the valve cap.
 - 2 Undo the rim nuts.
 - 3 Connect the bicycle air pump.
 - 4 Pump up the tyre slowly and pay attention to the tyre pressure in the process.
 - 5 Correct the tyre pressure to meet the specified value in the Pedelec pass.
 - 6 If the tyre pressure is too high, unfasten the union nut, let air out and re-tighten the union nut.
 - 7 Remove the bicycle air pump.
 - 8 Screw the valve cap tight.
 - 9 Screw the rim nut gently against the rim with the tips of your fingers.
- ⇒ Correct tyre pressure if necessary (see section 6.5.8).

Schrader valve**Only applies to pedelecs with this equipment**

- ✓ It is recommended to use an air pump at a filling station or a modern bicycle air with a pressure gauge. Older and simple bicycle air pumps are unsuitable for filling tyres via a Schrader valve.
 - 1 Unscrew and remove the valve cap.
 - 2 Undo the rim nuts.
 - 3 Connect the bicycle air pump.
 - 4 Pump up the tyre slowly and pay attention to the tyre pressure in the process.
- ⇒ The tyre pressure has been adjusted as per the specifications.

- 5 Remove the bicycle air pump.
 - 6 Screw the valve cap tight.
 - 7 Screw the rim nut gently against the rim with the tips of your fingers.
- ⇒ Correct tyre pressure if necessary (see section 6.5.8).

Presta valve**Only applies to pedelecs with this equipment**

- ✓ It is recommendable to use a bicycle air pump with a pressure gauge. You must observe the bicycle air pump operating instructions.
 - 1 Unscrew and remove the valve cap.
 - 2 Open the knurled nut around four turns.
 - 3 Carefully attach the bicycle air pump so that you do not bend the valve insert.
 - 4 Pump up the tyre slowly and pay attention to the tyre pressure in the process.
 - 5 Correct the tyre pressure as per the specifications on the tyre.
 - 6 Remove the bicycle air pump.
 - 7 Tighten the knurled nut with your fingers.
 - 8 Screw the valve cap tight.
 - 9 Screw the knurled nut gently against the rim with the tips of your fingers.
- ⇒ Correct tyre pressure if necessary (see section 6.5.8).

7.5.1.2 Checking the tyres

The tread is far less important for bicycle tyres than it is for car tyres, for example. Consequently, tyres can still be used with a worn tread with the exception of tyres on mountain bikes.

- 1 Check the tread for wear. The tyre is worn if the anti-puncture protection or the carcass cords are visible.

Since resistance to punctures also depends on the thickness of the tread, it may make sense to change the tyre at an earlier stage.



Figure 185: Tyres without a tread which can be replaced (1) and tyres with puncture protection showing through (2) must be replaced

- 2 Check the side walls for wear. If there are any cracks or tears, the tyre must be replaced.



Figure 186: Examples of fatigue cracks (1) and ageing cracks (2)

- 3 Replacing a wheel requires considerable mechanical expertise. If a tyre is worn, it needs to be replaced at a specialist dealer's.

7.5.1.3 Checking the rims



Crash caused by a worn rim

A worn rim can break and block the wheel. This may cause a crash with serious injuries.

- ▶ Check rim wear on a regular basis.
- ▶ Take pedelec out of service if the rim has any cracks or warping. Contact specialist dealer.

Rims are wear parts and wear away due to fatigue, mechanical impacts, environmental influences or due to braking if rim brakes are used.

- ▶ Check the rim well for wear.
- ⇒ The rims of a rim brake with invisible wear indicator are worn as soon as the wear indicator becomes visible in the area of the rim joint.
- ⇒ The rims with visible wear indicator are worn as soon as the black, all-round groove on the pad friction surface is no longer visible.
- ▶ We recommend that you also replace the *rims* at the same time as every second brake lining replacement.

7.5.1.4 Checking the nipple holes

Nipples cause fatigue and stress on the edge of the nipple hole.

- ▶ Check whether there are cracks on the edge of the nipple hole.

If there are cracks on the edge of the nipple hole, contact your specialist dealer.

7.5.1.5 Checking the nipple well

The nipple holes can weaken the tyre bed.

- ▶ Check to see if cracks are emerging from the nipple holes.
- ⇒ If there are cracks radiating from the nipple hole, contact your specialist dealer.

7.5.1.6 Checking the rim hooks

Mechanical impacts can warp the rim hooks. There is no longer a guarantee that a tyre can be fitted safely if this is the case.

- ▶ Check for twisted rim hooks.
- ⇒ Replace rims with twisted rim hooks. Never repair the rim with pliers and bend the hook back.

7.5.1.7 Checking the spokes

- ▶ Press spokes slightly together with your thumb and index finger. Check to ensure that the tension is the same for all spokes.
- ⇒ Contact your specialist dealer if the spokes are loose or are tensioned differently.

7.5.2 Checking the brake system



Crash caused by brake failure

Worn brake discs and brake linings and a lack of hydraulic fluid in the brake cable reduce the braking power. This may cause a crash with serious injuries.

- ▶ Check brake disc, brake linings and the hydraulic brake system regularly. Contact specialist dealer.

The inspection interval for the brake depends on how often it is used and the weather conditions. If the pedelec is used under extreme conditions such as rain, dirt or high mileage, inspection must be performed more frequently.

7.5.2.1 Checking the handbrake

- 1 Check that all screws in the handbrake are firmly in place (see Section 3.5.11).
 - 2 Tighten loose screws.
 - 3 Check that handbrake is torsionally rigid on the handlebars (see Section 3.5.11).
 - 4 Tighten loose screws.
 - 5 Check that there is a gap of at least 1 cm between the handbrake and the handle when the handbrake is fully applied.
 - 6 Adjust the grip distance if the gap is too narrow (see Section 6.5.9.6).
 - 7 Check the braking effect by pedalling while pulling the handbrake.
- ▶ If the braking power is too weak, adjust the brake pressure point (see Section 6.5.9.8).
 - ▶ Contact your specialist dealer if the pressure point cannot be reached.

7.5.2.2 Checking the hydraulic brake system

- 1 Pull on the handbrake and check whether any brake fluid leaks out of the lines, connections or on the brake linings.
- 2 If any brake fluid leaks from anywhere, take pedelec out of service. Contact specialist dealer.
- 3 Pull brake handbrake and hold several times.
- 4 If you are unable to clearly detect the pressure point and it changes, the brake needs to be bled. Contact specialist dealer.

7.5.2.3 Checking the Bowden cables

- 1 Pull on handbrake several times. Check whether the Bowden cables get stuck or they make scraping noises.
- 2 Check the physical condition of the Bowden cables for visible damage and check to see if wire strands are broken.
- 3 Have defective Bowden cables replaced. Contact specialist dealer.

7.5.2.4 Checking the disc brake

Only applies to pedelecs with this equipment

Checking the brake linings

- ▶ Check that the brake linings are no less than 1.8 mm wide at any point and there are no less than 2.5 mm between the brake lining and supporting plate.



Figure 187: Checking the brake lining when fitted with the help of the transport safety wear gauge

- 1 Check brake linings for damage and thick dirt.
 - ⇒ Have damaged or very dirty brake linings replaced. Contact specialist dealer.
- 2 Pull handbrake and hold.
- 3 In doing so, check whether the transport safety wear gauge can fit between the brake lining supporting plates.
 - ⇒ If the transport safety wear gauge fits between the supporting plates, the brake linings have not reached their wear limit.
 - ⇒ Contact your specialist dealer if they are worn.

Checking the brake discs

- ✓ Put on gloves as the brake disc is very sharp.
- 1 Take hold of brake disc and wiggle it gently to check whether the brake disc is positioned against the wheel free of backlash.
 - 2 Check that the brake linings move steadily and symmetrically back towards the brake disc when you pull and release handbrake.
 - ⇒ If the brake disc can be moved or the brake linings move erratically, contact your specialist dealer.
 - 3 Check that the brake disc is no less than 1.8 mm thick at any point.
 - ⇒ If the brake disc is under the wear limit and is less than 1.8 mm thick, the brake disc must be replaced. Contact specialist dealer.

7.5.3 Checking the chain

- ▶ Check chain for rust, damage and chain links that are difficult to move.
- ⇒ Replace rusted, damaged or difficult-to-move chains since they will not withstand the tensile loads from the drive and will soon break. Contact specialist dealer.

7.5.4 Checking the chain tension

Notice

Excessive chain tension increases wear. If the chain tension is too low, there is a risk that the *chain* will slip off the *chain wheels*.

- ▶ Check the chain tension once a month.

7.5.4.1 Check tension in derailleur gears

The rear derailleur tensions the chain on pedelecs with derailleur gears.

- 1 Check to see if the chain is sagging.
 - 2 Gently press the rear derailleur forwards to check whether it moves and whether it goes back into position by itself.
- ⇒ If the chain is sagging or the rear derailleur does not go back into position by itself, contact your specialist dealer.

7.5.4.2 Check tension in hub gear

- 3 Remove the chain guard on pedelecs with a circumferential chain guard.

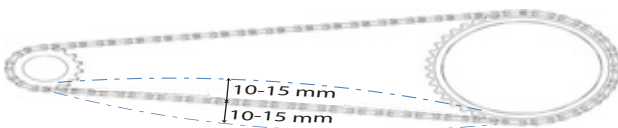

Figure 188: Checking the chain tension (example): 5 mm upwards, 10 mm downwards = 15 mm deviation

- 1 Lift chain upwards. Measure the distance to the centre. Press chain downwards. Measure the distance to the centre.

- 2 Add the two values together to calculate the deviation.
- 3 Check the chain tension at three to four points.
 - ⇒ If the deviation is greater than 20 mm, tighten chain.
 - ⇒ If the deviation is less than 10 mm, Loosen chain.
- ▶ If a hub gear is fitted, the rear wheel must be pushed backwards and forwards to tighten the chain. Contact specialist dealer.
- ▶ In the case of pedelecs with a hub gear or back-pedal brake, the chain is tensioned by an eccentric bearing or movable fork end in the bottom bracket axle. Special tools and specialist knowledge are required to tension the chain. Contact specialist dealer.

7.5.5 Checking the belt for wear

Each chain has a wear limit. If this limited is exceeded, the chain needs to be replaced.

Manufacturer	Wear limits
SHIMANO	>1%
KCM	>0.8 mm per link
SRAM	>0.8%
ROHLOFF	S: >0.1 mm per link A: >0.075 mm per link

Table 75: Chain wear limit by manufacturer

7.5.5.1 Rough check

You can perform a rough check on the chain wheel by hand on conventional chains

- 1 Place the chain on the largest chain wheel.
 - 2 Lift the chain from the front to the centre of the bike.
- ⇒ If the chain can be lifted more than half a link from the chain wheel, carry out a check or contact your specialist dealer.

7.5.5.2 Check

There is a different wear gauge for each chain, depending on the manufacturer:



Figure 189: Example of a KMC gauge



Figure 190: Example of a SHIMANO gauge



Figure 191: Example of a SRAM gauge



Figure 192: Example of a ROHLOFF gauge



Figure 193: Example of a KMC digital gauge

- 1 Insert gauge between two chain links on the right-hand side.

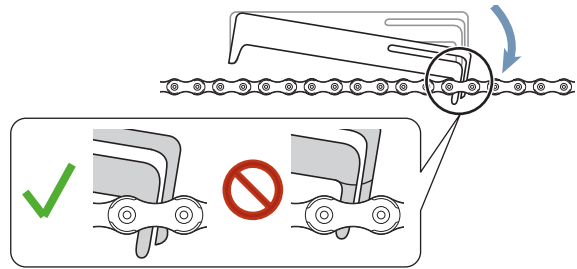

Figure 194: Gauge is inserted

- 2 Lower gauge down to the left-hand side.

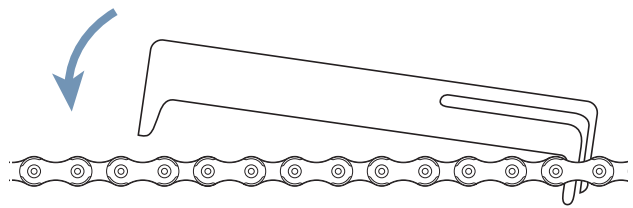

Figure 195: Lower gauge to the left

- ⇒ If the gauge does not fit between the links, the chain is not worn yet.

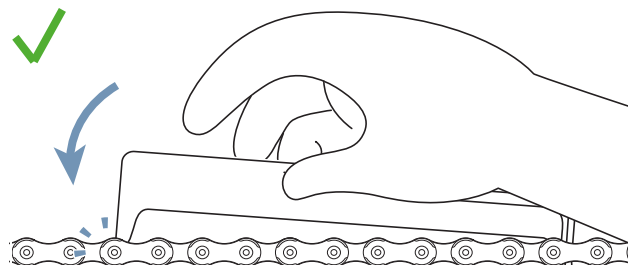

Figure 196: Gauge does not fit

- ⇒ If the gauge does not fit between the links, the chain is worn and must be replaced. Contact specialist dealer.

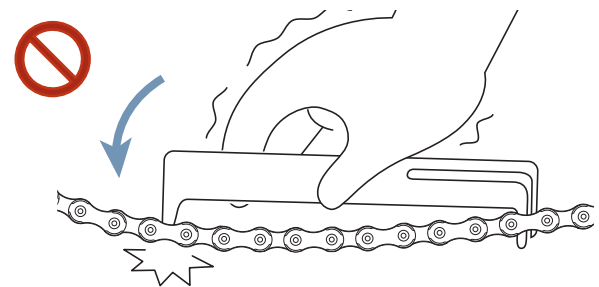

Figure 197: Gauge fits

7.5.6 Checking the belt

7.5.7 Checking the belt for wear

► Check belt for indications of wear:

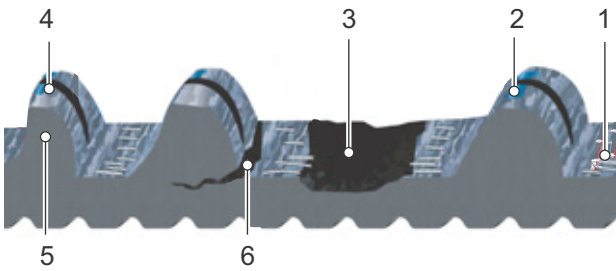

Figure 198: Indications of wear on a belt

- 1 Carbon tensile fibres are exposed
- 2 Worn webbing with visible polymer
- 3 Missing belt tooth
- 4 Imbalance
- 5 Shark tooth
- 6 Cracks

⇒ If there is one or more indications of wear, contact your specialist dealer. The belt needs to be replaced.

7.5.8 Checking the belt sprockets for wear

► Check belt sprocket.

⇒ The tooth profile is rounded and the teeth are thick. The belt sprocket does not need to be replaced.

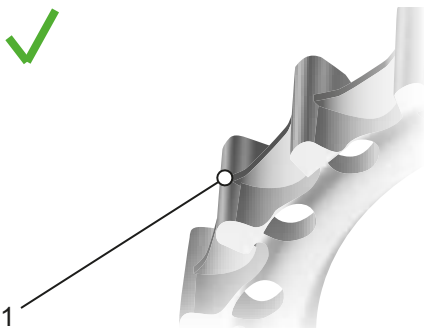

Figure 199: Optimum tooth profile

⇒ The tooth profile is pointed and teeth have worn thinner. Contact specialist dealer. The belt sprocket does need to be replaced.

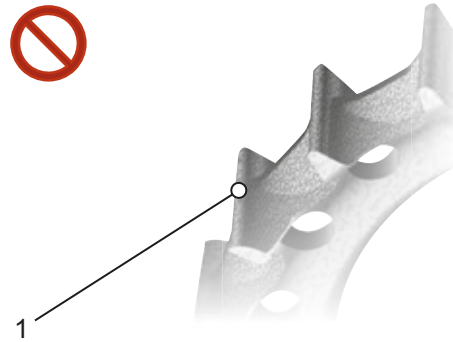

Figure 200: Worn tooth profile

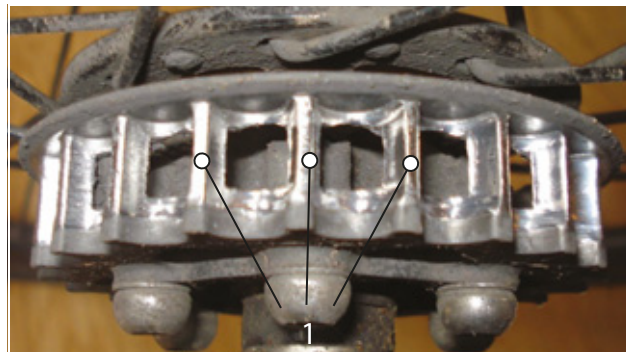

Figure 201: Photo showing example of worn tooth profile

7.5.9 Check belt tension

If the belt tension is too low, this can cause the system to skip over a tooth or slip, i.e. the teeth on the belt slip over the teeth on the rear wheel belt sprocket. Excessive tension can cause damage to the bearings, sluggishness in the system and increased wear on the electric drive system.

The adjustment of the belt tension varies depending on the pedelec. Common tensioning systems include angled or vertical drop-outs, horizontally sliding dropouts and eccentric bottom bracket axle.

There are three common methods of measuring belt tension:

- Gates Carbon Drive mobile app for iPhone® and Android®,
- Gates Krikkit tension meter and
- Eco tension tester.

With any of these methods, the tension along the belt may vary slightly, so you should repeat the process several times. Turn the pedal a quarter after each measurement. Measure again.

The tools measure the tension only. They do not provide specifications for the required voltage. The table below contains specifications for the correct tensioning range for Gates Carbon Drive belts

	Steady pedalling	Sports usage
MTBs* and single-speed bicycles	45– 60 Hz (35– 45 lbs)	60– 75 Hz (45– 53 lbs)
Hub gear/pinion gear	35– 50 Hz (28– 40 lbs)	

Table 76: Specifications for tensioning

* The CDN and SideTrack systems are not permitted for mountain bikes, e-bikes with mid-drive motor or gears, bikes without a gear shift or for trekking or touring bikes.

These tension specifications are designed as initial guidance and may have to be corrected upwards or downwards depending on the body size, gear ratio and the force applied to the pedals.

7.5.9.1 Gates Carbon Drive mobile app



The Gates Carbon Drive mobile app measures the belt tension based on the belt's natural frequencies (Hz). To do so, the app uses the phone's mic to record the sound of the belt and determines the main frequency.

- ✓ Download Gates Carbon Drive mobile app free of charge from the App Store or Google Play on your mobile phone.
- ✓ Measure in a quiet environment.
- ✓ Ensure that the phone microphone is switched on.

- 1 Open app.
 - 2 Click on the voltage symbol.
 - 3 Click on **MEASURE**.
 - 4 Point phone microphone towards the belt.
 - 5 Pluck the belt so that the belt vibrates like a guitar string.
 - 6 It is recommended to take several measurements for comparison. Turn the crank a quarter. Repeat frequency measurement.
 - 7 Check the belt frequency displayed against the specifications for tensions in Table 76.
- ⇒ If the value is higher than the specification, reduce belt tension,
- ⇒ If the value is within the specified range, the belt tension has been correctly adjusted.
- ⇒ If the value is lower than the specification, increase belt tension.

7.5.9.2 Gates Krikit tension meter

Not included in price

- ✓ Check that the measurement indicator is at the very bottom.

- 1 Extend index finger into the finger loop. Place on the check gauge.

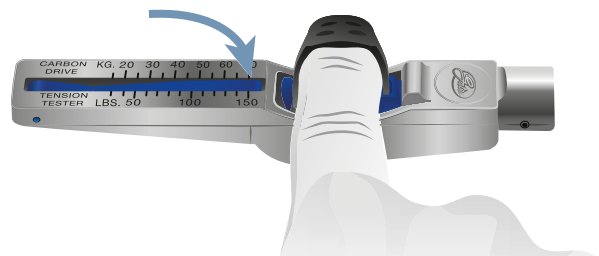

Figure 202: Index finger in the check gauge

- 2 Position check gauge on the upper surface of the belt. Position the check gauge in the middle of the belt length.

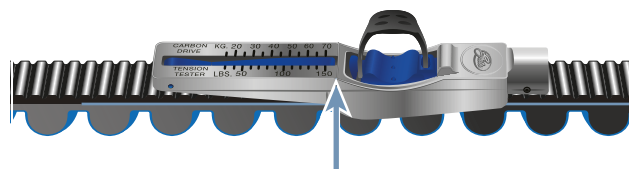

Figure 203: Check gauge on belt

- 3 Press the check gauge down with just one finger until it clicks into place.

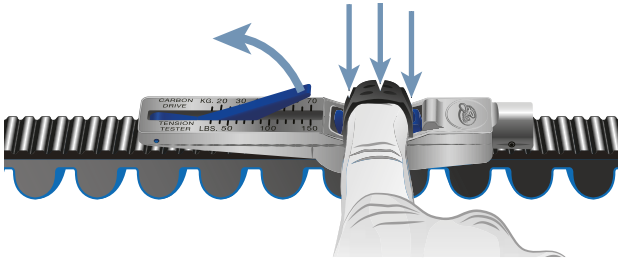

Figure 204: Pressing the check gauge down with one finger

- 4 Take reading where line A meets line B.

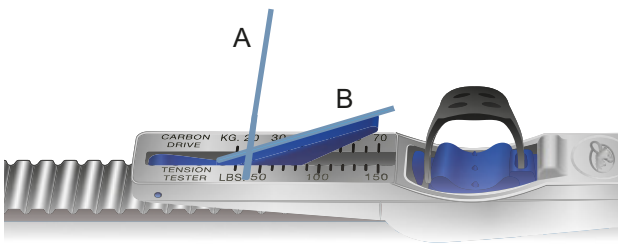

Figure 205: Example of a reading: 20 kg

- 5 Turn the pedal a quarter. Repeat measurement at least three times.
- 6 Convert value read from kg to pounds. The value is given in inches per pound.
Example: 20 kg = 44 inch = 44 lbs
- 7 Compare value with Table 44 Tension specification.
 - ⇒ If the value is higher than the specification, reduce belt tension,
 - ⇒ If the value is within the specified range, the belt tension has been correctly adjusted.
 - ⇒ If the value is lower than the specification, increase belt tension.

7.5.9.3 ECO tension tester

Not included in price

- 1 Attach the measuring stick on the belt.

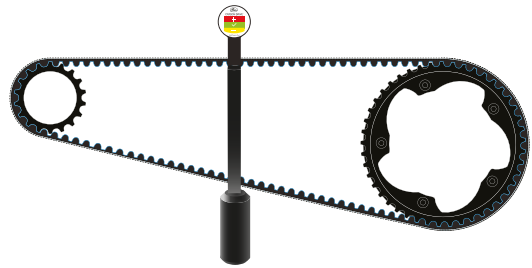

Figure 206: Attached measuring stick

- 2 Place the ruler on both belt sprockets.

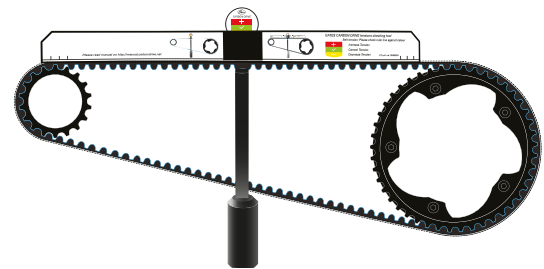

Figure 207: Ruler in place

- ⇒ Read tension on the tension indicator.

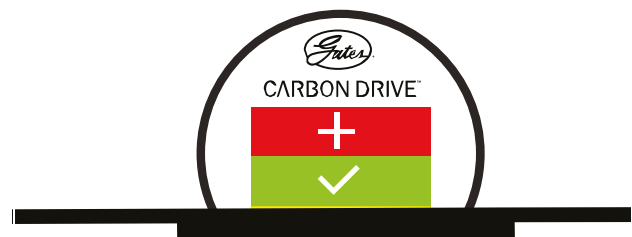

Figure 208: Example: On yellow along lower edge, so reduce belt tension slightly

- Red = increase belt tension
- Green = belt tension is set correctly
- Yellow = reduce belt tension

7.5.10 Checking the riding light

- 1 Check the cable connections on the headlight and rear light for damage and corrosion and ensure they are firmly in position.
- ⇒ If cable connections are damaged or corroded, or are not firmly in positioned. take pedelec out of service. Contact specialist dealer.
- 2 Switch light on.
- 3 Check that the headlight and rear light come on.

- ⇒ If the headlight or rear lights do not come on, take pedelec out of service. Contact specialist dealer.
- 4 Place pedelec 5 m from the wall.
- 5 Stand the pedelec up straight. Hold the handlebars straight with both hands. Do not use the kickstand.

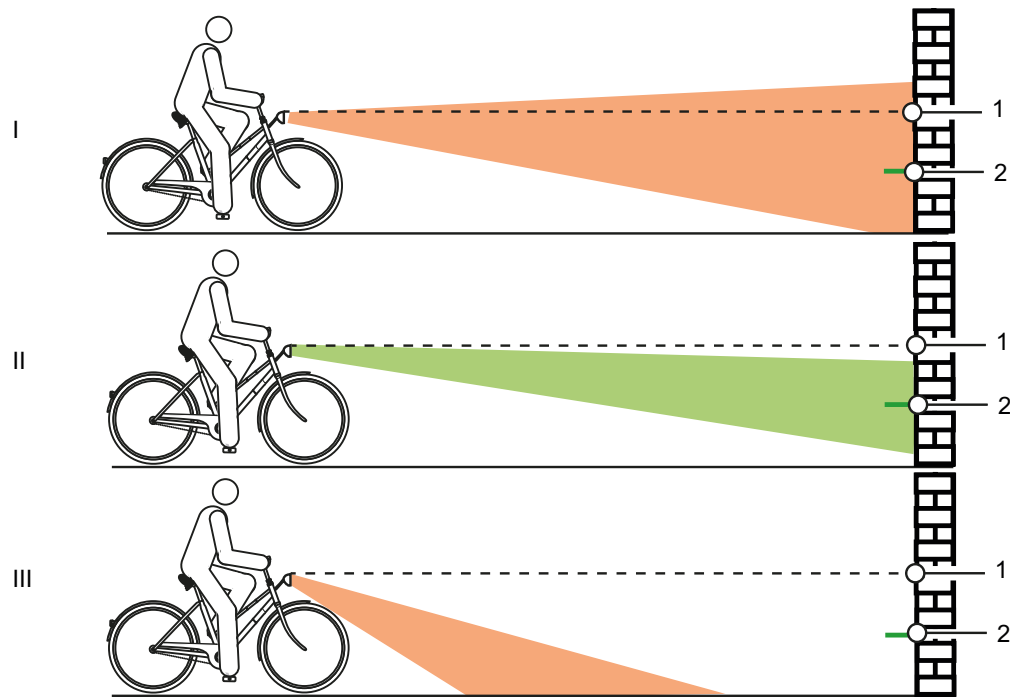

Figure 209: Light positioned too high (1), correctly (2) and too low (3)

- 6 Check the position of the light beam.
- ⇒ If the light is positioned too high or too low, adjust riding light (see Section [6.5.17.1](#)).

7.5.11 Checking the stem

- ▶ The stem and quick release system must be inspected at regular intervals. The specialist dealer should adjust them if they require adjustment.
- ▶ If the hexagon socket head screw is also loosened, the bearing clearance also needs to be adjusted. Medium-strength thread locker, such as Loctite blue, then needs to be applied to the loosened screws and the screws tightened as per specifications.
- ▶ Check metal contact surfaces on cone, stem clamping screw and fork steerer for corrosion.
- ⇒ Take pedelec out of service if there is any wear or signs of corrosion. Contact specialist dealer.

7.5.12 Checking the handlebars

- 1 Take hold of handlebars with both hands on the handles.
 - 2 Move handlebars up and down and press to tilt.
- ⇒ If the handlebars move, Contact specialist dealer.
- 3 Place front wheel in position where it can't move sideways (e.g. in a bike stand).
 - 4 Hold handlebars firmly with both hands.
 - 5 Check if the handlebars are able to twist against the front wheel.
- ⇒ If the handlebars can move, contact your specialist dealer.

7.5.13 Checking the saddle

- 1 Hold saddle firmly.
 - 2 Check whether the saddle twists, tilts or can be pushed in one direction or other.
- ⇒ If the saddle twists, tilts or can be pushed in one direction or other, adjust the saddle (see Section 6.5.4).
 - ⇒ Contact your specialist dealer if the saddle cannot be fixed into position.

7.5.14 Checking the seat post

- 1 Take seat post out of the frame.
 - 2 Check seat post for cracks and corrosion.
 - 3 Reinsert seat post.
 - 4 Check pedal.
 - 5 Hold pedal and try to move it sideways toward the inside or outside. In doing so, observe whether the crank arm or bearing move sideways.
- ⇒ If the pedal, crank arm or crank bearing moves sideways, fasten screw on the pedal crank rear.
- 6 Hold pedal and try to move it upwards and downwards vertically. In doing so, observe whether the pedal, crank arm or crank bearing moves vertically.
- ⇒ If the pedal, crank arm or crank bearing moves vertically, fasten screw.

7.5.14.1 Checking the derailleur gears

The chain is tensioned by the rear derailleur in pedelecs with derailleur gears.

- 1 Place the pedelec on stand.
 - 2 Check to see if the chain is sagging.
 - 3 Gently press the rear derailleur forwards to check whether it moves and whether it goes back into position by itself.
- ⇒ If the chain is sagging or the rear derailleur does not go back into position by itself, contact your specialist dealer.

7.5.14.2 Checking the hub gear

In the case of pedelecs with a hub gear or back-pedal brake, the chain or the belt is tensioned by an eccentric bearing or movable fork end in the bottom bracket axle. Special tools and specialist knowledge are required to tension the chain.

Contact specialist dealer.

✓ Remove the chain guard on pedelecs with a circumferential chain guard.

- 1 Place the pedelec on stand.
- 2 Check the chain or belt tension in three or four positions, turning the crank a full revolution.

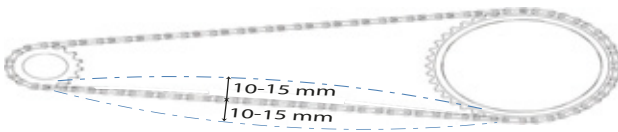

Figure 210: Checking the chain tension

- ⇒ If the chain or the belt can be pushed more than 2 cm, the chain will need to be re-tensioned. Contact specialist dealer.
- ⇒ If the chain or belt can only be pushed up and down less than 1 cm, you will need to the chain or belt slightly. Contact specialist dealer.
- ⇒ The ideal chain and belt tension has been achieved if the chain can be pushed between a maximum of 10 and 15 mm in the middle between the pinion and the toothed wheel. The crank must also turn without resistance.

7.5.15 Check gear shift

- 1 Check that all gear shift components are free of damage.
- 2 Contact your specialist dealer if components are damaged.
- 3 Place the pedelec on stand.
- 4 Turn the pedal crank clockwise.
- 5 Switch through all speeds.
- 6 Check that pedelec can switch through all speeds without making unusual noises.
- 7 Adjust the gear shift if gears cannot be changed correctly.

7.5.15.1 Checking the electric gear shift

- 1 Check the cable connections for damage and corrosion and ensure they are firmly in position.
- ⇒ If cable connections are loose, damaged or corroded, contact your specialist dealer.

7.5.15.2 Check the mechanical gear shift

- 1 Change gear a number of times. Check whether the Bowden cables get stuck or they make scraping noises.
 - 2 Check the physical condition of the Bowden cables for visible damage and check to see if wire strands are broken.
- ⇒ Have defective Bowden cables replaced. Contact specialist dealer.

7.5.15.3 Checking the derailleur gears

- 1 Check that there is clearance between the chain tensioner and spokes.
 - ⇒ If there is no clearance or the chain scrapes against the spokes or tyres, contact your specialist dealer.
- 2 Check that there is clearance between the chain or rear derailleur and spokes.
 - ⇒ If there is no clearance or the chain scrapes against the spokes, contact your specialist dealer.

7.5.16 Adjusting gear shift

7.5.16.1 Adjusting the ROHLOFF hub

Only applies to pedelecs with this equipment

- 1 Check whether shift cable tension is set in such a way that there is a perceptible play of around 5 mm when the shift handle is turned.
- 2 Adjust the shift cable tension by turning the **tension adjuster**.
 - ⇒ Unscrew the **tension adjuster** to increase the shift cable tension.
 - ⇒ Tighten the tension adjuster to decrease the shift cable tension.

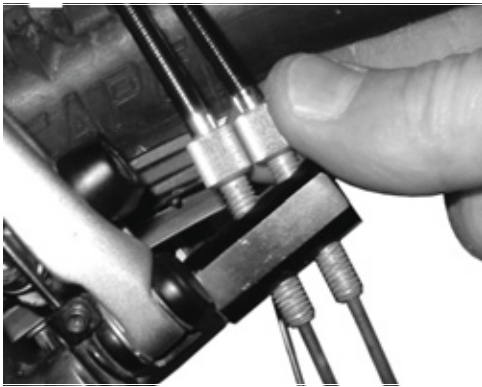

Figure 211: The tension adjuster on ROHLOFF hub versions with internal switch control is located on the tension counter support



Figure 212: The tension adjuster on ROHLOFF hub versions with external switch control is located on the cable box positioned on the left-hand side

- 3 If the marking and numbers on the shift handle to no longer coincide after the gear shift is adjusted, tighten one of the tension adjusters and screw out the other tension adjuster to the same extent.

7.5.17 Adjusting cable-operated gear shift, dual-cable

Only applies to pedelecs with this equipment

- ▶ For a smooth gear shift, adjust the **adjusting sleeves** underneath the chain stay on the frame.
- ▶ The shift cable has around 1 mm play when it is pulled out gently.

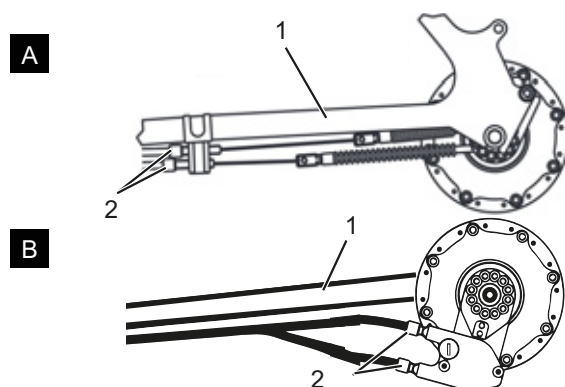

Figure 213: Adjusting sleeves (2) on two alternative versions (A and B) of a dual-cable, Bowden-cable-operated gear shift on the chain stay (1)

7.5.18 Adjusting Bowden-cable-operated twist grip, dual-cable

Only applies to pedelecs with this equipment

- ▶ For a smooth gear shift, adjust the **adjusting sleeves** on the shifter housing.
- ⇒ There is noticeable play of 2 to 5 mm (1/2 gear) when you turn the twist grip.

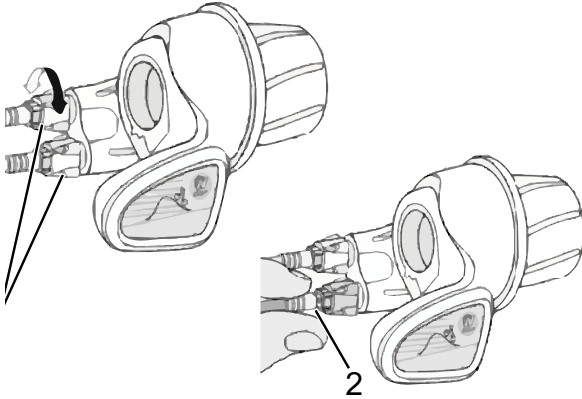

Figure 214: Twist grip with adjusting sleeves (1) with play (2)

7.5.19 Checking kickstand stability

- 1 Place the pedelec on a slight elevation of 5 cm.
 - 2 Extend kickstand.
 - 3 Jolt pedelec to check stability.
- ⇒ If pedelec topples over, tighten screws or change height of the kickstand.

8 Inspection and maintenance

8.1 Initial inspection

After 200 km or 4 weeks after purchase

Vibrations produced while riding can cause screws and springs that were tightened during pedelec manufacture to settle or come loose.

- ▶ Arrange an appointment for the initial inspection directly when purchasing the pedelec.
- ▶ Have the initial inspection entered and stamped in the maintenance book.



- ▶ Carrying out the initial inspection, see Section 8.4.

8.2 Major inspection

every six months

You must have your specialist dealer perform a major inspection every six months as a minimum. This is the only way to ensure that the pedelec remains safe and fully functional.

Tasks require technical expertise, special tools and special lubricants. The pedelec may become damaged if the stipulated major inspection and procedures are not carried out. This is why only specialist dealers may carry out the major inspection.

- ▶ Contact your specialist dealer and arrange an appointment.
- ▶ Enter and stamp major inspection tasks in the maintenance book.



- ▶ Perform major inspection

8.3 Component-specific maintenance

High-quality components require extra maintenance. Tasks require technical expertise, special tools and special lubricants. The pedelec may become damaged if the stipulated maintenance intervals and procedures are not carried out. This is why only specialist dealers may carry out maintenance.

Correct maintenance on the fork not only guarantees a long service life, but also ensures optimal performance.

Each maintenance interval shows the maximum cycling hours for the required type of maintenance that the component manufacturer recommends.

- ▶ Optimise performance with shorter maintenance intervals, depending on use, terrain and environmental conditions.



- ▶ Enter any components with extra maintenance requirements with their corresponding maintenance intervals into the maintenance book when the pedelec is purchased.
- ▶ Inform the buyer of the additional maintenance schedule.
- ▶ Have maintenance tasks entered and stamped in the maintenance book.

Inspection and maintenance intervals for suspension fork		
SR SUNTOUR suspension fork		
<input type="checkbox"/>	Maintenance 1	Every 50 hours
<input type="checkbox"/>	Maintenance 2	Every 100 hours
FOX suspension fork		
<input type="checkbox"/>	Maintenance	Every 125 hours or once a year
RockShox suspension fork		
<input type="checkbox"/>	Maintenance of stanchions for: Paragon™, XC™ 28, XC 30, 30™, Judy®, Recon™, Sektor™, 35™*, Bluto™, REBA®, SID®, RS-1™, Revelation™, PIKE®, Lyrik™, Yari™, BoXXer	Every 50 hours
<input type="checkbox"/>	Maintenance of spring and damper unit for: Paragon, XC 28, XC 30,30 (2015 and earlier), Recon (2015 and earlier), Sektor (2015 and earlier), Bluto (2016 and earlier), Revelation (2017 and earlier), REBA (2016 and earlier), SID (2016 and earlier), RS-1 (2017 and earlier), BoXXer (2018 and earlier)	Every 100 hours
<input type="checkbox"/>	Maintenance of spring and damper unit for: 30 (2016+), Judy (2018+), Recon (2016+), Sektor (2016+), 35 (2020+)*, Revelation (2018+), Bluto (2017+), REBA (2017+), SID (2017+), RS-1 (2018+), PIKE (2014+), Lyrik (2016+), Yari (2016+), BoXXer (2019+)	Every 200 hours

Inspection and maintenance intervals for seat post		
by.schulz suspension seat post		
<input type="checkbox"/>	Maintenance	After the first 250 km; every 1,500 km after that
Eightpins suspension seat post		
<input type="checkbox"/>	Clean wiper	20 hours
<input type="checkbox"/>	Clean slide bushing	40 hours
<input type="checkbox"/>	Replace slide bushing, wiper and felt strip	100 hours
<input type="checkbox"/>	Seal service for gas pressure spring	200 hours
FOX suspension seat post		
<input type="checkbox"/>	Maintenance	Every 125 hours or once a year
KINDSHOCK suspension seat post		
<input type="checkbox"/>	Maintenance	Every 6 months
RockShox dropper post		
<input type="checkbox"/>	Venting of remote control lever and/or maintenance of lower seat post unit for: Reverb™ A1/A2/B1, Reverb Stealth A1/A2/B1/C1*	Every 50 hours
<input type="checkbox"/>	Detach lower seat post, clean brass pins, check and replace if necessary and apply new grease for Reverb AXS™ A1*	Every 50 hours
<input type="checkbox"/>	Venting of remote control lever and/or maintenance of lower seat post unit for: Reverb B1, Reverb Stealth B1/C1*, Reverb AXS™ A1*	Every 200 hours
<input type="checkbox"/>	Complete maintenance of seat post for: Reverb A1/A2, Reverb Stealth A1/A2	Every 200 hours
<input type="checkbox"/>	Complete maintenance of seat post for: Reverb B1, Reverb Stealth B1	Every 400 hours
<input type="checkbox"/>	Complete maintenance of seat post for: Reverb AXS™ A1*, Reverb Stealth C1*	Every 600 hours
SR SUNTOUR suspension seat post		
<input type="checkbox"/>	Maintenance	Every 100 hours or once a year
All other suspension seat posts		
<input type="checkbox"/>	Maintenance	Every 100 hours

Inspection and maintenance intervals for rear frame damper		
RockShox rear frame damper		
<input type="checkbox"/>	Service air chamber assembly	Every 50 hours
<input type="checkbox"/>	Service damper and spring	Every 200 hours
FOX rear frame damper		
<input type="checkbox"/>	Maintenance	Every 125 hours or once a year
SR SUNTOUR rear frame damper		
<input type="checkbox"/>	Complete shock absorber service including damper reassembly and air seal replacement	Every 100 hours

Inspection and maintenance intervals for hub		
SHIMANO 11-speed hub		
<input type="checkbox"/>	Internal oil change and maintenance	1,000 km after start of use, then every 2 years or 2,000 km
All other SHIMANO gear hubs		
<input type="checkbox"/>	Lubricate internal components	Once a year or every 2,000 km
ROHLOFF Speedhub 500/14		
<input type="checkbox"/>	Clean cable box and grease cable drum interior	every 500 km
<input type="checkbox"/>	Oil change	Every 5,000 km or at least once a year
Pinion		
<input type="checkbox"/>	Maintenance 1 Check drive elements and replace if necessary Clean cable pulley, slide surfaces and gear box interior, epicyclic wheels, etc. thoroughly and grease generously	every 500 km
<input type="checkbox"/>	Maintenance 2 Replace chain rings and change oil	every 10,000 km

 **WARNING**
Injury due to damaged brakes

Special tools and specialist knowledge are required to repair the brakes. Incorrect or unauthorised assembly can damage the brakes. This may lead to an accident with serious injuries.

- ▶ Only specialist dealers may carry out repairs on brakes.
- ▶ Only carry out work or changes, such as dismantling, sanding or painting, which are permitted and described in the brake operating instructions.

Injury to the eyes

Problems may arise if the settings are not made properly and you may sustain serious injuries as a result.

- ▶ Always wear safety glasses during Inspection and maintenance work.

 **CAUTION**
Crash and falling caused by unintentional activation

There is a risk of injury if the electric drive system is activated unintentionally.

- ▶ Remove the battery before inspection or maintenance.

Crash caused by material fatigue

If the service life of a component has expired, the component may suddenly fail. This may cause a crash with injuries.

- ▶ Have the specialist dealer carry out basic cleaning of the pedelec every six months, preferably at the same time as the required servicing work.

 **CAUTION**
Hazard for the environment due to toxic substances

The brake system contains toxic and environmentally harmful oils and lubricants. Such fluids will contaminate if they enter the sewers or groundwater.

- ▶ Dispose of lubricants and oils left over after repairs in an environmentally responsible way in accordance with statutory regulations.

Notice

The motor is maintenance-free and only qualified specialist personnel may open it.

- ▶ Never open the motor.

8.4 Carry out initial inspection

Incorrectly fastened screws may come loose due to impact. The stem may no longer be firmly fixed in its position as a result. This will cause a crash with injuries.

- ▶ Check the handlebars and the stem quick release system are firmly in position after the first two hours of riding.

Vibrations produced while riding can cause screws and springs that were tightened during manufacture of the pedelec to settle or come loose.

- 1 Check quick release system is fixed in position.
- 2 Check all tightening torques of screws and screw connections.



8.5 Perform major inspection

Complying with these inspection and maintenance instructions is the only way to reduce wear on components, increase the operating hours and guarantee safety.

Diagnosis and documentation of current status

Components	Frequency	Description			Criteria		Measures if rejected
		Inspection	Tests	Inspection/ maintenance	Acceptance	Rejection	
Chassis							
Frame	Once a month	Dirt	...	Section 7.3.4	O.K.	Dirt	Cleaning
	6 months	Maintenance	...	Section 7.4.1	O.K.	Untreated	Wax
	6 months	Check for damage – fracture, scratches	Section 8.6.1	...	O.K.	Damage detected	Take pedelec out of service, new frame as specified in parts list
Carbon frame (optional)	Once a month	Dirt	Section 7.3.4	...	O.K.	Dirt	Cleaning
	6 months	Maintenance	...	Section 7.4.1	O.K.	No wax	Wax
	6 months	Damage to paintwork	Section 8.6.1.1	...	O.K.	Damage to paintwork	Apply paint
ROCKSHOX Rear frame damper (optional)	6 months	Check for damage, corrosion, fracture	See ROCKSHOX component maintenance instructions	Maintenance as specified by manufacturer Air chamber assembly group, damper and spring	O.K.	Damage detected	New rear frame damper as specified in parts list
	6 months	Check for damage, corrosion, fracture	...	Send to FOX	O.K.	Damage detected	New rear frame damper as specified in parts list
	6 months	Check for damage, corrosion, fracture	See SR SUNTOUR component maintenance instructions	Maintenance as specified by manufacturer Complete shock absorber service including damper reassembly and air seal replacement	O.K.	Damage detected	New rear frame damper as specified in parts list
Steering system							
Handlebars	Once a month	Cleaning	...	Section 7.3.6	O.K.	Dirt	Cleaning
	6 months	Wax	...	Section 7.4.7	O.K.	Untreated	Wax
	6 months	Check mount fastening	Section 7.5.12	...	O.K.	Loose, rust	Retighten screws; new handlebars as specified in parts list if necessary
Stem	Once a month	Cleaning	...	Section 7.3.5	O.K.	Dirt	Cleaning
	6 months	Wax	...	Section 7.4.6	O.K.	Untreated	Wax
	6 months	Check mount fastening	Section 7.5.11 and Section 8.6.4	...	O.K.	Loose, rust	Retighten screws; new stem as specified in parts list if necessary



Components	Frequency	Description			Criteria		Measures if rejected
		Inspection	Tests	Maintenance	Acceptance	Rejection	
Handles	Once a month	Cleaning	...	Section 7.3.7	O.K.	Dirt	Cleaning
	Once a month	Care	Section 7.4.8	...	O.K.	Untreated	Talcum powder
	before each ride	Wear; check if fastened securely	Section 7.1.11	...	O.K.	Missing, wobbles	Retighten screws, new handles and coverings as specified in parts list
Steering headset	6 months	Clean and check for damage	...	Clean, lubricate and adjust	O.K.	Unclean	Clean and lubricate
Fork (rigid)	6 months	Check for damage, corrosion, fracture	...	Dismount, check, lubricate, refit	O.K.	Damage detected	New fork as specified in the parts list
Carbon fork (optional)	6 months	Check for damage, corrosion, fracture	...	Maintenance as specified by manufacturer Lubrication, oil change as specified by manufacturer	O.K.	Damage detected	New fork as specified in the parts list
SR SUNTOUR suspension fork (optional)	6 months	Check for damage, corrosion, fracture	...	Maintenance as specified by manufacturer Lubrication, oil change as specified by manufacturer	O.K.	Damage detected	New fork as specified in the parts list
FOX suspension fork (optional)	6 months	Check for damage, corrosion, fracture	...	Send to FOX	O.K.	Damage detected	New rear frame damper as specified in parts list
RockShox suspension fork (optional)	6 months	Check for damage, corrosion, fracture	...	Maintenance as specified by manufacturer Lubrication, oil change as specified by manufacturer	O.K.	Damage detected	New fork as specified in the parts list
Spinner suspension fork (optional)	6 months	Check for damage, corrosion, fracture	...	Maintenance as specified by manufacturer Lubrication, oil change as specified by manufacturer	O.K.	Damage detected	New fork as specified in the parts list
Wheel							
Wheel	before each ride	Concentricity	Section 7.1.7	...	O.K.	Not straight	Re-mount wheel
	6 months	Assembly	Section 7.5.1	...	O.K.	Loose	Adjust quick release
Tyres	Once a month	Cleaning	Section 7.3.10	...	O.K.	Dirt	Cleaning
	once a week	Tyre pressure	Section 7.5.1.1	...	O.K.	Tyre pressure too low/too high	Adjust tyre pressure
	10 days	Wear	Section 7.3.10	...	O.K.	Worn profile	New tyre as specified in the parts list



Components	Frequency	Description			Criteria		Measures if rejected
		Inspection	Tests	Maintenance	Acceptance	Rejection	
Rims	6 months	Wax	...	Section 7.4.10	O.K.	Untreated	Wax
	6 months	Wear	Section 7.5.1.3	...	O.K.	Defective rim	New rim as specified in the parts list
	Once a month	Wear on brake surface	Section 7.5.2.6	...	O.K.	Worn brake surface	New rim as specified in the parts list
Spokes	Once a month	Cleaning	...	Section 7.3.11	O.K.	Dirt	Cleaning
	3 months	Check tension	Section 7.5.1.3	...	O.K.	Loose, tension varies	Re-tension spokes or new spokes as specified in parts list
	6 months	Check rim hooks	Section 7.5.1.3	...	O.K.	Twisted rim hooks	New rim as specified in the parts list
Spoke nipples	Once a month	Cleaning	...	Section 7.3.11	O.K.	Dirt	Cleaning
	Once a month	Wax	...	Section 7.4.13	O.K.	Untreated	Wax
Nipple holes	6 months	Check for cracks	Section 7.5.1.4	...	O.K.	Cracks	New rim as specified in the parts list
Nipple well	Once a year	Check for cracks	Section 7.5.1.5	...	O.K.	Cracks	New rim as specified in the parts list
Hub	Once a month	Cleaning	...	Section 7.3.12	O.K.	Dirt	Cleaning
	Once a month	Care	...	Section 7.4.12	O.K.	Untreated	Treat
Hub with cone bearing (optional)	Once a month	Cleaning	...	Section 7.3.12	O.K.	Dirt	Cleaning
	Once a month	Care	...	Section 7.4.12	O.K.	Untreated	Treat
	6 months	Check mount fastening	O.K.	Loose, rust	Retighten screws; new handlebars as specified in parts list if necessary
	Once a year	Adjust	O.K.	Not adjusted	New position
Hub gear (optional)	Once a month	Cleaning	...	Section 7.3.12	O.K.	Dirt	Cleaning
	Once a month	Care	...	Section 7.4.12	O.K.	Untreated	Treat
	6 months	Check mount fastening	O.K.	Loose, rust	Retighten screws; new handlebars as specified in parts list if necessary
	6 months	Functional check	Section 7.5.14.2	incorrect switching	Readjust hub
Saddle and seat post							
Saddle	Once a month	Cleaning	...	Section 7.3.9	O.K.	Dirt	Cleaning
	6 months	Check mount fastening	Section 7.5.13	...	O.K.	Loose	Retighten screws
Leather saddle (optional)	Once a month	Cleaning	...	Section 7.3.9.1	O.K.	Dirt	Cleaning
	6 months	Care	...	Section 7.4.11	O.K.	Untreated	Leather wax
	6 months	Check mount fastening	Section 7.5.13	...	O.K.	Loose	Retighten screws
Seat post	Once a month	Cleaning	...	Section 7.3.8	O.K.	Dirt	Cleaning
	6 months	Care	O.K.	Untreated	Leather wax
	6 months	Complete clean, check fastening and paint protection film	...	Section 8.6.8	O.K.	Loose	Tighten screws, new paint protection film



Components	Frequency	Description			Criteria		Measures if rejected
		Inspection	Tests	Maintenance	Acceptance	Rejection	
Carbon seat post (optional)	Once a month	Cleaning	...	Section 7.3.8	O.K.	Dirt	Cleaning
	6 months	Care	...	Section 7.4.9.2	O.K.	Untreated	Assembly paste
	6 months	Complete clean, check fastening and paint protection film	...	Section 8.6.8.1	O.K.	Loose	Tighten screws, apply new paint protection film; new seat post as specified in parts list if damaged
Suspension seat post (optional)	Once a month	Cleaning	O.K.	Dirt	Cleaning
	6 months	Care	...	Section 7.4.9.1	O.K.	Untreated	Oils
	100 hours or 6 months	Complete clean, check fastening and paint protection film	Section 8.6.8	...	O.K.	Loose	Tighten screws, new paint protection film
by.schulz suspension seat post (optional)	After the first 250 km; every 1500 km after that	Complete clean, check fastening and paint protection film, lubricate	Section 8.6.8.2	...	O.K.	Loose	Tighten screws, apply new paint protection film; new seat post as specified in parts list if damaged
SR SUNTOUR suspension seat post	every 100 hours or once a year	Complete clean, check fastening and paint protection film, lubricate	Section 8.6.8.3	...	O.K.	Loose	Tighten screws, apply new paint protection film; new seat post as specified in parts list if damaged
Eightpins NGS2 Suspension seat post	20 hours	Refill oil	...	Section 7.4.19	O.K.	No oil	Refill oil
	20 hours	Clean wiper	...		O.K.	Dirt	Cleaning
	40 hours	Clean slide bushing	...		O.K.	Dirt	Cleaning
	100 hours	Replace slide bushing, wiper and felt strip	...		O.K.	No replacement	Replace
	200 hours	Seal service for gas pressure spring	...		O.K.	No service	Carry out the service
Eightpins H01 Suspension seat post	20 hours	Refill oil	...	Section 7.4.19	O.K.	No oil	Refill oil
	20 hours	Clean wiper	...		O.K.	Dirt	Cleaning
	40 hours	Clean slide bushing	...		O.K.	Dirt	Cleaning
	100 hours	Replace slide bushing, wiper and felt strip	...		O.K.	No replacement	Replace
	200 hours	Seal service for gas pressure spring	...		O.K.	No service	Carry out the service



Components	Frequency	Description			Criteria		Measures if rejected
		Inspection	Tests	Maintenance	Acceptance	Rejection	
RockShox dropper post	50 hours	Venting	...	See manufacturer	O.K.		
	50 hours	Cleaning	...	See manufacturer	O.K.		
	200 hours	Venting	...	See manufacturer	O.K.		
	200 hours	Complete maintenance	...	See manufacturer	O.K.		
	400 hours	Complete maintenance	...	See manufacturer	O.K.		
	600 hours	Complete maintenance	...	See manufacturer	O.K.		
FOX suspension seat post	Every 125 hours or once a year	Complete maintenance	See manufacturer	At the manufacturer FOX	
Safety guards							
Belt or chain guards	6 months	Attachment	Check mount fastening	...	O.K.	Loose	Retighten screws
Guard	6 months	Attachment	Check mount fastening	...	O.K.	Loose	Retighten screws
Motor cover	6 months	Attachment	Check mount fastening	...	O.K.	Loose	Retighten screws
Brake system							
Handbrake	6 months	Attachment	Check mount fastening	...	O.K.	Loose	Retighten screws
Brake fluid	6 months	Check fluid level	Depending on time of year	...	O.K.	Too little	Top up brake fluid; take Pedelec out of service if damaged; new brake hoses
Brake linings	6 months	Brake linings, brake discs and rims	Check for damage	...	O.K.	Damage detected	New brake linings, brake discs and rims
Back-pedal brake braking armature	6 months	Attachment	Check mount fastening	...	O.K.	Loose	Retighten screws
Brake system	6 months	Attachment	Check mount fastening	...	O.K.	Loose	Retighten screws
Lighting system							
Light cabling	6 months	Connections, correct wiring	Check	...	O.K.	Cable defective, no light	New cabling
Rear light	6 months	Side light	Functional check	...	O.K.	No constant light	New rear light as specified in parts list; replace if necessary
Front light	6 months	Side light, daytime riding light	Functional check	...	O.K.	No constant light	New front light as specified in parts list; replace if necessary
Reflectors	6 months	All complete, state, fastening	Check	...	O.K.	Damaged or not all complete	New reflectors



Components	Frequency	Description			Criteria		Measures if rejected
		Inspection	Tests	Maintenance	Acceptance	Rejection	
Drive/gear shift							
Chain/cassette/pinion/chainring	6 months	Check for damage	Check for damage	...	O.K.	Damage	Refasten if necessary or replace as specified in parts list
Chain guard/spoke guard	6 months	Check for damage	Check for damage	...	O.K.	Damage	Replace as specified in parts list
Bottom bracket axle/crank	6 months	Check mount fastening	Check mount fastening	...	O.K.	Loose	Retighten screws
Pedals	6 months	Check mount fastening	Check mount fastening	...	O.K.	Loose	Retighten screws
Shifter	6 months	Check mount fastening	Check mount fastening	...	O.K.	Loose	Retighten screws
Shift cables	6 months	Check for damage	Check for damage	...	O.K.	Loose and defective	Adjust shift cables; new shift cables if necessary
Front derailleur	6 months	Check for damage	Check for damage	...	O.K.	Gear shift difficult or not possible	Adjust
Rear derailleur	6 months	Check for damage	Check for damage	...	O.K.	Gear shift difficult or not possible	Adjust
Electric drive system							
On-board computer	6 months	Check for damage	Check for damage	...	O.K.	No screen, defective screen display	Restart, test battery, new software or new on-board computer, decommissioning,
Control panel	6 months	Check control panel for damage	Check for damage	...	O.K.	No response	Restart; contact control panel manufacturer, new control panel
Tachometer	6 months	Calibration	Speed measurement	...	O.K.	Pedelec travelling 10% too fast/slow	Take pedelec out of service until the source of the error is found
Cabling	6 months	Visual inspection	Visual inspection	...	O.K.	Failure in system, damage, kinked cables	New cabling
Rechargeable battery	6 months	First examination	See Section on Assembly	...	O.K.	Error message	Contact battery manufacturer; take out of service, new battery
Battery mount	6 months	Firmly in position, lock, contacts	Check mount fastening	...	O.K.	Loose; lock doesn't close, no contacts	New battery mount
Motor	6 months	Visual inspection and mount	Check mount fastening	...	O.K.	Damage, loose	Refasten motor, contact motor manufacturer, new motor; take out of service
Software	6 months	Check version	Check software version	...	In latest version	Not latest version	Import update



Components	Frequency	Description			Criteria		Measures if rejected
		Inspection	Tests	Maintenance	Acceptance	Rejection	
Miscellaneous							
Pannier rack	before each ride	Stability	Section 7.1.5	...	O.K.	Loose	Firm
	Once a month	Dirt	...	Section 7.3.4	O.K.	Dirt	Cleaning
	6 months	Maintenance	...	Section 7.4.3	O.K.	Untreated	Wax
	6 months	Check fastening and paint protection film	Section 8.5.2	...	O.K.	Loose	Tighten screws, new paint protection film
Kickstands	Once a month	Dirt	...	Section 7.3.4	O.K.	Dirt	Cleaning
	6 months	Maintenance	...	Section 7.4.5	O.K.	Untreated	Wax
	6 months	Attachment	Section 7.5.19	...	O.K.	Loose	Retighten screws
	6 months	Stability	Section 7.5.19	...	O.K.	Tips over	Change kickstand height
Bell	before each ride	Sound	Functional check, Section 7.1.10.	...	O.K.	No ring, too quiet, missing	New bell as specified in the parts list
Attachments (optional)	6 months	Attachment	Check mount fastening	...	O.K.	Loose	Retighten screws

Technical inspection, checking safety, test ride

Components	Description		Criteria		Measures if rejected
	Assembly/inspection	Tests	Acceptance	Rejection	
Brake system	6 months	Functional check	O.K.	No full braking; braking distance too long	Locate defective part in brake system and correct
Gear shift under operating load	6 months	Functional check	O.K.	Problems when shifting gear	Readjust gear shift
Suspension components (fork, shock absorber, seat post)	6 months	Functional check	O.K.	Suspension too deep or no longer exists	Locate defective component and correct
Electric drive system	6 months	Functional check	O.K.	Loose connection, problems when riding, accelerate	Locate faulty component in electric drive and remedy
Lighting system	6 months	Functional check	O.K.	No continuous light, not bright enough	Locate defective part in lighting system and correct
Test ride	6 months	Functional check	No strange noises	Strange noises	Locate source of noise and correct



8.5.1 Inspect frame

- 1 Check frame for cracks, warping and damage to the paintwork.
- ⇒ If there are any cracks, warping or damage to the paintwork, remove the pedelec from service. New frame as specified in the parts list.

8.5.1.1 Inspecting the carbon frame

You need to distinguish between scratches on the paintwork and impacts if the carbon frame paintwork is damaged.

- ▶ Ask customer what caused the damage.
- ▶ Examine damage with a magnifying glass to see if fibres are permanently damaged or delamination has taken place.

8.5.2 Inspecting the pannier rack

Scratches, cracks and breaks may appear on the pannier rack caused by the panniers and cargo boxes.

- 1 Examine pannier rack for scratches, cracks and breaks.
- ⇒ Replace damaged pannier racks.
- ⇒ If the paint protection film is missing or has worn away, affix a new paint protection film.

8.5.3 Inspecting and maintaining the rear frame damper

Only applies to pedelecs with this equipment



WARNING

Injury due to explosion

The air chamber is pressurised. If the air system is serviced in a rear frame damper, it can explode and cause serious injury.

- ▶ Wear safety goggles, protective gloves and safety clothing when assembling or carrying out maintenance on the bicycle.
- ▶ Release the air for the air chambers. Detach all air insert fitments.
- ▶ Never service or dismantle a rear frame damper if it has not completely rebounded.

Intoxication from suspension oil

Suspension oil is poisonous to the touch, irritates respiratory tracts and causes cancer, sterility and mutation in germ cells.

- ▶ Always wear safety goggles and nitrile gloves when carrying suspension oil.
- ▶ Never perform inspection or maintenance when you are pregnant.
- ▶ Use an oil catchment tray under the section where the rear frame damper is being serviced.

Intoxication from lubrication oil

The lubrication oil for Eightpins seat posts is toxic if touched or inhaled.

- ▶ Always wear safety goggles and nitrile gloves when working with lubrication oil.
- ▶ Lubricate seat post in the open air or in a well-ventilated room only.
- ▶ Avoid skin coming into contact with lubrication oil. Wear nitrile gloves when lubricating, cleaning and maintaining the vehicle.
- ▶ Use an oil catchment tray under the section where the seat post is serviced.

 **CAUTION**
Hazard for the environment due to toxic substances

The rear frame damper contains toxic and environmentally harmful oils and lubricants. Such fluids will contaminate if they enter the sewers or groundwater.

- ▶ Dispose of lubricants and oils left over after repairs in an environmentally responsible way in accordance with statutory regulations.

- 1 Dismantle the rear frame damper.
 - 2 Clean and inspect its interior and exterior.
 - 3 Recondition air springs.
 - 4 Replace airtight seals on air springs.
 - 5 Change oil.
- ⇒ Replace dust wipers.

8.5.4 Inspecting the gear hub

8.5.4.1 Adjusting the hub with cone bearing

In the case of hubs with a cone bearing, the bearing shell fixed in the hub cone body rotates with its larger ball bearing surfaces around the inner bearing cone resting against the fork end. The outer bearing shell rotating around the stationary bearing cone is subject to considerably more evenly distributed loads thanks to its larger ball running surface.

- 1 Attach a small, red colour marking on the lock nut.
 - 2 Turn the wheel axle 40° to 90° every 1,000 to 2,000 km.
- ⇒ The bearing cone is subject to evenly distributed loads.

8.5.5 Inspecting the stem

Incorrectly fastened screws may come loose due to impact. The stem may no longer be firmly fixed in its position as a result. This will cause a crash with injuries.

- ▶ Check the handlebars and the stem's quick release are firmly in position.

8.5.6 Inspect and grease steering headset

- 1 Remove fork.
- 2 Clean steering headset. If it is very dirty, flush the bearing with cleaning agents such as WD-40 or Karamba.
- 3 Check steering headset for damage.
 - ⇒ If the steering headset is damaged, replace steering headset as specified in the parts list.
- 4 Grease steering headset and bearing seat with highly viscous, water-repellent grease (e.g. Dura Ace special grease by SHIMANO).
- 5 Re-fit fork with steering headset as per fork instructions.



8.5.7 Inspecting the axle with quick release

CAUTION

Crash caused by unfastened quick release

A faulty or incorrectly installed quick release may become caught in the brake disc and block the wheel. This will cause a crash.

- ▶ Install the front wheel quick release lever on the opposite side to the brake disc.

Crash caused by faulty or incorrectly installed quick release

The brake disc becomes very hot during operation. Parts of the quick release may become damaged as a result. The quick release comes loose. This will cause a crash with injuries.

- ▶ The front wheel quick release lever and the brake disc must be situated on opposite sides.

Crash caused by incorrectly set clamping force

Excessively high clamping force will damage the quick release and cause it to lose its function.

Insufficient clamping force will cause a detrimental transmission of force. The suspension fork or the frame may break. This will cause a crash with serious injuries.

- ▶ Never fasten a quick release using a tool (e.g. hammer or pliers).
- ▶ Only use the clamping lever with the specified set clamping force.

- 1 Undo quick release.
- 2 Fasten quick release.
- 3 Check the position and clamping force of the quick release lever.

- ⇒ The quick release lever is flush with the lower housing.
- ⇒ You should be able to see slight impression on the palm of your hand when you close the quick release lever.



Figure 215: Adjusting the quick release clamping force

- 4 Use a 4 mm hexagon socket spanner to adjust the clamping lever clamping force if required.
- 5 Check the quick release lever position and clamping force again.



Figure 216: Adjusting the quick release clamping force



8.5.8 Inspecting the fork

WARNING

Injury due to explosion

The air chamber is pressurised. When the air system in a faulty suspension fork is maintained, it may explode and cause serious injury.

- ▶ Wear safety goggles, protective gloves and safety clothing when assembling or carrying out maintenance on the bicycle.
- ▶ Release the air for the air chambers. Detach all air insert fitments.
- ▶ Never service or dismantle a suspension fork if it has not completely rebounded.

CAUTION

Hazard for the environment due to toxic substances

The suspension fork contains toxic and environmentally harmful oils and lubricants. Such fluids will contaminate if they enter the sewers or groundwater.

- ▶ Dispose of lubricants and oils left over after repairs in an environmentally responsible way in accordance with statutory regulations.

- 1 Remove fork.
- 2 Check fork for cracks, warping and damage to the paintwork.
 - ⇒ If there are any cracks, warping or damage to the paintwork, remove the pedelec from service. New fork as specified in the parts list.
- 3 Clean inside and exterior.
- 4 Grease fork.
- 5 Install fork.

8.5.8.1 Inspecting the carbon suspension fork

Only applies to pedelecs with this equipment

- 1 Remove fork.
- 2 Check fork for cracks, warping and damage to the paintwork.
- 3 You need to distinguish between scratches on the paintwork and impacts if the carbon suspension fork paintwork is damaged.
 - ▶ Ask customer what caused the damage.
 - ▶ Examine damage with a magnifying glass to see if fibres are permanently damaged or delamination has taken place.

8.5.8.2 Inspecting the suspension fork

Only applies to pedelecs with this equipment

- 1 Remove fork.
- 2 Check fork for cracks, warping and damage to the paintwork.
 - ⇒ If there are any cracks, warping or damage to the paintwork, remove the pedelec from service. New fork as specified in the parts list.
- 3 Dismantle suspension fork.
- 4 Lubricate dust seals and slide bushings.
- 5 Check torques.
- 6 Clean inside and exterior.
- 7 Grease fork.
- 8 Install fork.
- 9 Adjust suspension fork (see Section 6.3.14).



8.5.9 Inspecting the seat post



WARNING

Intoxication from lubrication oil

The lubrication oil for Eightpins seat posts is toxic if touched or inhaled.

- ▶ Always wear safety goggles and nitrile gloves when working with lubrication oil.
- ▶ Lubricate seat post in the open air or in a well-ventilated room only.
- ▶ Avoid skin coming into contact with lubrication oil. Wear nitrile gloves when lubricating, cleaning and maintaining the vehicle.
- ▶ Use an oil catchment tray under the section where the seat post is serviced.

- 1 Remove seat post from the frame.
- 2 Clean seat post on the inside and outside.
- 3 Examine seat post rack for scratches, cracks and fractures.
 - ⇒ Replace damaged seat post as specified in the parts list.
- 4 Fit seat post as per height specifications in the pedevec pass.

8.5.9.1 Inspecting the carbon seat post

Only applies to pedevecs with this equipment

You need to distinguish between impacts and scratches on the paintwork if the carbon seat post paintwork is damaged.

- ▶ Ask customer what caused the damage.
- ▶ Examine damage with a magnifying glass to see if fibres are permanently damaged or delamination has taken place.

8.5.9.2 Inspecting and greasing BY.SCHULZ suspension seat post

Only applies to pedevecs with this equipment

- 1 Remove seat post from the frame.
- 2 Remove safety and protective cover.
- 3 Clean seat post on the inside and outside.
- 4 Examine seat post rack for scratches, cracks and fractures.
 - ⇒ Replace damaged seat post as specified in the parts list.
- 5 Lubricate screws in the parallel suspension.
- 6 Reinsert seat post as per height specifications in the pedevec pass. Check screws for correct tightening torques.

<input type="checkbox"/>	Torques G1 M8 seat clamp screw M5 fixing grub screws	20 ... 24 Nm 3 Nm
<input type="checkbox"/>	Torque G2 M6 seat clamp screw M5 fixing grub screws	12 ... 14 Nm 3 Nm

- 7 Put on safety and protective cover.



8.5.9.3 Inspecting and greasing RS SUNTOUR suspension seat post

Only applies to pedelecs with this equipment

- 1 Remove seat post from the frame.
- 2 Remove safety and protective cover.
- 3 Examine seat post rack for scratches, cracks and fractures.
 - ⇒ Replace damaged seat post as specified in the parts list.
 - ⇒ If the paint protection film protecting a child seat is missing or has worn away, affix a new paint protection film.
- 4 Undo preload adjuster and take out steel spring.
- 5 Clean seat post on inside and outside.
- 6 Grease seat post on inside with SR SUNTOUR grease no. 9170-001.
- 7 Lubricate pressure roller with bicycle chain oil.
 - ▶ Lubricate articulated joints in parallel suspension with bike chain oil.



Figure 217: SR SUNTOUR suspension seat post lubrication points

- 8 Reinsert seat post as per height specifications in the pedelec pass.
- 9 Check screws for correct tightening torques.

□	SR SUNTOUR suspension seat post torques	
	Seat clamp screw	15–18 Nm
	M5 fixing grub screws	3 Nm

- 10 Put on safety and protective cover.

9 Troubleshooting, fault clearance and repair

9.1 Preventing pain

A pedelec is a sports vehicle which promotes health.

After the first few rides, you may experience sore muscles the next day. However, permanent pain should never occur during or after a ride.

Medical problems may be the cause of pain. Any such problems should thus always be discussed openly with a doctor.

In most cases, however, pain after pedelec rides is due to a lack of training and components set incorrectly or components that are not adjusted to the rider's physique.

The most common complaints are:

- 1 Sitting discomfort
- 2 Pain in hips
- 3 Backache
- 4 Pain in shoulders and nape of neck
- 5 Numb or aching hands
- 6 Pain in upper thigh
- 7 Pain in the knee
- 8 Pain in the foot

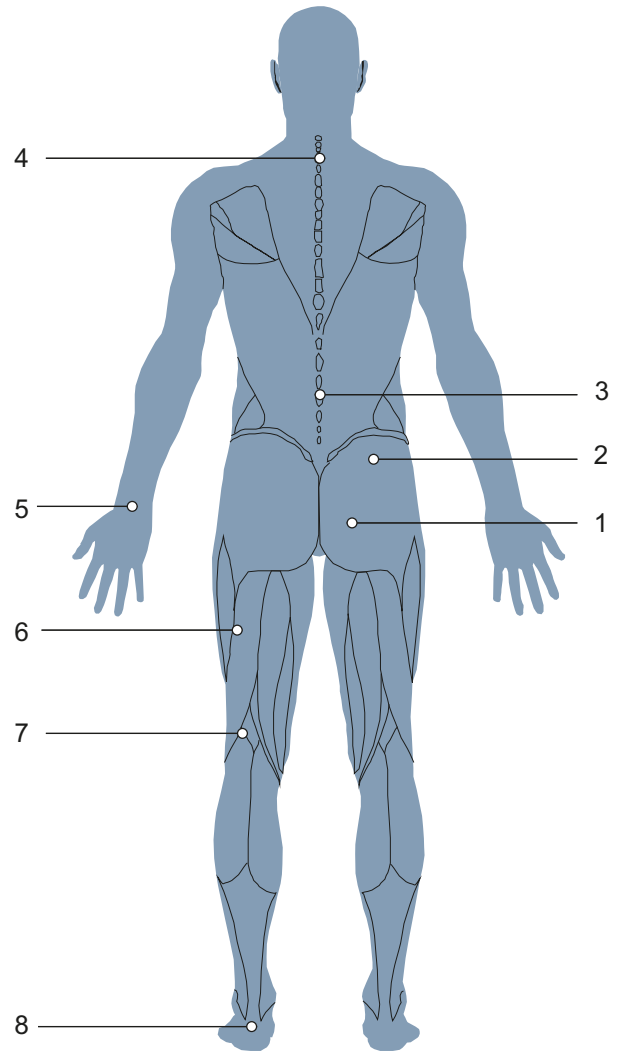

Figure 218: Known pain due to lack of training and/or incorrect component adjustment

9.1.1 Sitting discomfort

Around 50% of all pedelec riders experience sitting discomfort:

- Pressure pain in the sitting bones
- Pain in the lower back
- Pressure pain and numbness in perineal region

Solution

- Adopt an optimal riding position (see Section 6.5.3).
- Adjust the saddle height and tilt (see Section 6.5.4).
- Wear cycling shorts and use chamois cream (see Section 6.12).
- Use an ergonomically adjusted saddle (see Section 6.5.4).



- Ride standing up now and again.

9.1.2 Pain in hips

Lower back pain is often not caused by the back muscles, but by the iliopsoas muscle instead. This muscle is part of the inner hip musculature and flexes the hip. It is attached to the thigh bone and reaches up to the spine. Pain can occur in the back if this muscle is strained too much or shortened.

Solution



- Strengthening exercises for the iliopsoas muscle
- Stretching exercises for hip flexors and extensors.

9.1.3 Backache

Riding a pedelec strengthens the back musculature. The greater the saddle-to-bar drop is, the greater the strain on the back musculature is. At the beginning, a posture where you lean too far forward can lead to pain in the back, arms and wrists. The abdominal muscles are the counterpart to the back muscles and stabilise the pelvis and the back. Back pain is thus often caused by weak abdominal muscles.

Solution



- Contact specialist dealer. You need to adopt a more upright sitting position (see Section 6.5.3).
- Stretching exercises for the back and abdominal muscle ligaments and moderate bicycle training will lengthen the tendons and build new back and abdominal muscles.

The desired position can be adopted after a period of training.

9.1.4 Pain in shoulders and nape of neck

The weight of the upper body places a strain on the shoulders due to the bent-forward posture. The more stretched the position is, the more strain there is on the shoulders.

The specific posture adopted is often the source of pain. Pedelec riders often extend their arms. Impacts such as those occurring on bumpy roads are thus transmitted to the shoulders without suspension. This causes severe pain.

Another source of pain is a hunchback. Due to the posture adopted, the neck needs to be extended backwards excessively so that the rider can look forwards. This causes strain in the neck and shoulder muscles.

9.1.5 Numb or aching hands

Your hands are one of the three points of contact when you ride a pedelec. The hands transmit the weight of the upper body to the handlebars. In the upright Holland position, there is almost no weight applied whereas body weight is at its highest in the sports position. The force is applied to a small area on the handle, meaning the pressure load on the hands is very high. Hands are highly sensitive and can bear a maximum of 20% of body weight during prolonged exposure to load.

9.1.6 Pain in upper thigh

Pain in the upper thigh is usually due to muscular problems. A muscular imbalance between the extensors, flexors and adductors can cause this pain.

Solution



- A more upright riding position will immediately reduce pain.
- Always bend elbows slightly.
- ⇒ The elbow joint will not block. The arms cushion impacts.
- Adjust the handlebars (see Section 6.5.5).
- Always adopt an optimal riding position (see Section 6.5.3).

Solution

- Position handles perfectly (see Section 6.5.5.1, 6.5.5.2 and 6.5.8)
- Move hands and arms while riding (see Section 6.15)
- Use padded cycling gloves (see Section 2.15)
- Optimise handles (see Section 6.5.7).

Solution

- Increasing assistance on the pedelec will bring immediate relief.



- Targeted exercises to correct imbalance and shortening of the thigh muscles.
- Stretching exercises for the thigh muscles.

9.1.7 Knee pain

Pedelec riding is a sport that is easy on the knee joints and is recommended for beginners. Very powerful forces are transmitted from the thigh to the foot via the knee when pedalling. As a result, the tendons and cartilage in the knee are subjected to great stress.

Pain on the inside and outside of the knee is often caused by incorrect adjustment of the click system and the foot being out of position as a consequence. Pain in the lower part of the knee usually stems from an improper riding position.

Cold weather can also cause knee pain. Tendons are less elastic at low temperatures and thus rub against the knee more.

If the knee is out of position, the cartilage becomes very worn. Ligaments that are too short or muscular imbalances can increase this effect. Pain on the top of the kneecap often indicates a muscular imbalance. Pain under the kneecap is usually related to excessive pressure in the knee joint and consequential irritation to the patellar tendon

9.1.8 Pain in the foot

Your feet are one of three points of contact when you ride a pedelec. Feet transmit force from the upper thigh to the pedal, thus driving the pedelec. In the process, your feet are subjected to between 100% and, during jumps, even up to 1,000% of your body weight

Foot pain often arises when the saddle is too low or the foot is placed incorrectly on the pedal.

Unsuitable shoes can also be the cause of pain in the feet.

Solution

- Contact specialist dealer. Have the pedelec adjusted (see Section 6.5). Then measure the wheel.
- Avoid cold.



- Get imbalances under control through stretching exercises, strengthening the muscles and Blackroll training.

Solution

- Wear sturdy shoes which are not too tightly laced (see Section 2.5).
- Position feet correctly on the pedals (see Section 6.13).
- Adjust the saddle height to an optimum position (see Section 6.5.4).

9.2 Troubleshooting and fault clearance

The on-board computer indicates whether a critical or less critical error has arisen in the drive system.

The error messages generated by the drive system can be read in the eBike Flow app and by the specialist dealer.

The rider can use a link in the eBike Flow app to display all information on errors and assistance on eliminating errors.

9.2.1 Drive system or on-board computer does not start up

If the on-board computer and/or the drive system do not start up, proceed as follows:

- 1 Check whether the battery is switched on. If not, start the battery.
⇒ Contact your specialist dealer if the battery level indicator LEDs do not light up.
- 2 If the LEDs on the Battery Level indicator light up, but the drive system does not start, remove the battery.
- 3 Insert the battery.
- 4 Start the drive system.
- 5 If the drive system does not start up, remove the battery.
- 6 Clean all the contacts with a soft cloth.
- 7 Insert the battery.
- 8 Start the drive system.
- 9 If the drive system does not start up, remove the battery.
- 10 Fully charge the battery.
- 11 Insert the battery.
- 12 Start the drive system.
- 13 If the drive system does not start, press the **On-Off button (on-board computer)** for at least 8 seconds.
- 14 If the drive system does not start after about 6 seconds, press the **On-Off button (on-board computer)** for at least 2 seconds.
- 15 Contact your specialist dealer if the drive system won't start.

9.2.2 Errors in assistance function

Symptom	Cause	Remedy
Assistance is not available.	Is the battery charged sufficiently?	<ol style="list-style-type: none"> 1 Check battery is charged. 2 Recharge the battery if it is almost flat.
	Is the system switched on?	<ul style="list-style-type: none"> ▶ Press On-Off button (battery). ⇒ The drive system starts.
	Is the level of assistance set to [OFF]?	<ol style="list-style-type: none"> 1 Set the assistance mode to a different level of assistance than [OFF]. 2 Contact your specialist dealer if you still feel that the no assistance is being supplied.
	The rechargeable battery, on-board computer or assistance switch may be connected incorrectly, or one or more of them may have a problem.	▶ Contact specialist dealer.
	Are the pedals being pushed?	<p>The pedelec is not a motorbike.</p> <ul style="list-style-type: none"> ▶ Push the pedals.
	Is the speed too high?	<p>The electronic gear assistance is only active up to a maximum speed of 25 km/h.</p> <ul style="list-style-type: none"> ▶ Check on-board computer indicators.
	Is the lock function activated?	▶ Use suitable on-board computer.
	The battery may become too hot during rides at high temperatures, up long inclines or when carrying a heavy load for a long time.	<ol style="list-style-type: none"> 1 Switch off the drive system. 2 Leave pedelec to cool down. 3 Start the drive system.
The assisted journey distance is too short.	Is the battery fully charged?	<ol style="list-style-type: none"> 1 Check charge level. 2 Recharge the battery if it is almost flat.
	The battery does not perform as well in winter weather.	This does not indicate a problem.
	The journey distance can be shorter depending on the road conditions, the gear level and the entire light usage time.	This does not indicate a problem.
	The battery is a consumable. Repeated charging and long periods of use cause the battery to degrade (loss of power).	<p>If the distance covered with a fully charged battery has become shorter, the battery may be affected.</p> <ul style="list-style-type: none"> ▶ Replace old battery with new one.
It is difficult to pedal.	Are the tyres pumped to an adequate pressure?	<ol style="list-style-type: none"> 1 Pump up tyres.
	Is the level of assistance set to [OFF]?	<ol style="list-style-type: none"> 1 Set level of assistance to [HIGH], [STD], [ECO] or [AUTO]. 2 Contact your specialist dealer if the pedals are still stiff.
	Is the battery fully charged?	<ol style="list-style-type: none"> 1 Check charge level. 2 Recharge the battery if it is almost flat.
	Have you switched on the system with your foot on the pedal?	<ol style="list-style-type: none"> 1 Switch system on again without applying pressure to the pedal. 2 Contact your specialist dealer if the pedals are still stiff.

Table 77: Error solution for assistance system

9.2.3 Battery errors

Symptom	Cause	Remedy
The battery discharges very quickly.	The battery may be at the end of its useful life.	► Replace old battery with new one.
The battery cannot be recharged.	Is the charger mains plug firmly connected to the socket?	<ol style="list-style-type: none"> 1 Disconnect the charger mains plug and plug it in again. 2 Start charging. 3 If the battery still won't recharge, contact your specialist dealer.
	Is the charger plug firmly connected to battery?	<ol style="list-style-type: none"> 1 Disconnect the charger plug and plug it in again. 2 Start charging. 3 If the battery still won't recharge, contact your specialist dealer.
	Is the adapter firmly connected to the charger plug or the battery's charging port?	<ol style="list-style-type: none"> 1 Connect the adapter firmly to the charger plug or the battery charging port. 2 Start charging. 3 If the battery still won't recharge, contact your specialist dealer.
	Is the connection terminal for the charger, charger adapter or batteries dirty?	<ol style="list-style-type: none"> 1 Wipe with a dry cloth to clean the connection terminals. 2 Start charging. 3 If the battery still won't recharge, contact your specialist dealer.
The battery does not start charging when the charger is connected.	The battery may be at the end of its useful life.	► Replace old battery with new one.
The battery and charger become hot.	Has the battery or charger temperature exceeded the operating temperature range?	<ol style="list-style-type: none"> 1 Interrupt charging process. 2 Leave battery and charger to cool down. 3 Start charging. <p>⇒ If the battery becomes too hot to touch, there might be a problem with the battery.</p> <ol style="list-style-type: none"> 4 Contact specialist dealer.
The charger is hot.	If the charger is used continuously to charge batteries, it may become hot.	<ol style="list-style-type: none"> 1 Interrupt charging process. 2 Leave charger to cool down. 3 Start charging.
The LED on the charger does not light up.	The LED on the charger will go out when the battery is fully charged.	This is not a malfunction.
	Is the charger plug firmly connected to battery?	<ol style="list-style-type: none"> 1 Check connection for any contaminants. 2 Insert charger plug. 3 If the battery still won't recharge, contact your specialist dealer.
	Is the battery fully charged?	<ol style="list-style-type: none"> 1 Disconnect charger mains plug. 2 Insert mains plug again. 3 Start charging. 4 Contact your specialist dealer if the LED on the charger still doesn't light up.
The battery cannot be removed.		► Contact specialist dealer.
The battery cannot be inserted.		► Contact specialist dealer.
Fluid is leaking from the battery.		► Observe all the warnings in Section 2 Safety.

Table 78: Error solution for battery

Symptom	Cause	Remedy
There is an unusual smell.		<ol style="list-style-type: none"> 1 Remove from the battery immediately. 2 Contact the fire service immediately. 3 Observe all the warnings in Section 2 Safety.
Fumes are emitted from the battery.		<ol style="list-style-type: none"> 1 Remove from the battery immediately. 2 Contact the fire service immediately. 3 Observe all the warnings in Section 2 Safety.

Table 78: Error solution for battery

9.2.4 Display screen errors

Symptom	Cause	Remedy
No data are shown on the display screen if you press the on-off button (battery) .	The battery charge level may be insufficient.	<ol style="list-style-type: none"> 1 Charge the battery. 2 Switch on the power.
	Is the power switched on?	▶ Press the On-Off button (battery) to switch the power on.
	Is the battery charged?	If the battery is fitted to the pedelec and is being charged, it cannot be switched on. ▶ Interrupt charging.
	Is the connector fitted to the power cable correctly?	<ol style="list-style-type: none"> 1 Check whether the connector is fitted to the power cable correctly. 2 If the connector is not fitted correctly, contact your specialist dealer.
	A component may be connected which the system is unable to recognise.	▶ Contact specialist dealer.
The gear level is not shown on the display screen.	The gear level is only shown if the electronic gear shift is used.	<ol style="list-style-type: none"> 1 Check that the power cable connector has not been disconnected. 2 If this is not the case, contact your specialist dealer.
The settings menu cannot be opened while you are pedalling.	The product is designed in such a way that the settings menu cannot be opened if the system detects that someone is riding the pedelec. This is not a malfunction.	<ol style="list-style-type: none"> 1 Stop the pedelec. 2 Change settings when stationary only.
The lock function cannot be set up or switched off.	It may be a firmware error.	▶ Contact specialist dealer.
The connect account has been deleted or deactivated and the lock function is still activated.	...	▶ Contact specialist dealer.

Table 79: On-board computer error solution

9.2.5 Lighting does not work

Symptom	Cause	Remedy
Front lamp or rear lamp does not go on, even when the switch is pressed.	The default settings in the electric drive system have probably been configured incorrectly.	<ol style="list-style-type: none"> 1 Take pedelec out of service immediately. 2 Contact specialist dealer.
	The light is defective.	

Table 80: Lighting error solution

9.2.6 Problems with disc brakes

Symptom	Cause	Remedy
Ringing and unusual sounds from the disc brake	Riding on tarmac with off-road tyres	▶ Contact specialist dealer. Fit a city or trekking tyre.
Low braking power from the disc brake	Dirty or greasy brake disc	▶ Clean brake disc thoroughly with white spirit or brake cleaner.
	Worn brake disc	▶ Contact specialist dealer. New brake disc.
	Worn brake lining	▶ Contact specialist dealer. New brake linings.
	Brake lining vitrification	
Metallic noises from disc brake	Worn brake linings.	▶ Contact specialist dealer. New brake linings and brake disc.
Spongy, soft or poor pressure point in disc brakes	Brake calliper fitted incorrectly, brake disc loose, brake disc or brake lining worn or brake system leaking.	▶ Contact specialist dealer.
Noises when a disc brake is applied	Dirt	1 Clean brake disc and brake thoroughly. 2 If the problem is not solved, contact your specialist dealer.
	Worn or incorrect brake linings	▶ Contact specialist dealer. New brake linings and brake discs.
	Wheel, hub or axle fitted incorrectly.	▶ Contact specialist dealer. Check brake system and wheel assembly.
	Brake calliper and/or brake disc fitted incorrectly	
	Incorrect torques	
	Brake disc damaged by side impact	
	Vitrified brake linings	
	Brake system leaking	
	Incorrect brake mount height	

Table 81: Disc brake error solution

9.2.7 Problems with freewheel

Symptom	Cause	Remedy
Freewheel blocked	Cover forgotten after fitting.	▶ Contact specialist dealer. Check installation correct.
	After fitting, socket was compressed by over-tightening the quick-release axle.	▶ Contact specialist dealer. Measure the length of the socket. If the socket is shorter than 15.4 mm, replace socket.
Freewheel slips or does not lock into place	After maintenance: Too much or wrong grease on the toothed discs.	▶ Contact specialist dealer. Remove hub. Clean and grease toothed disc.
	Toothed discs are worn.	▶ Contact specialist dealer. Replace toothed disc.
	One or both springs were forgotten after fitting.	▶ Contact specialist dealer. Check installation correct.
	One or both toothed discs are fitted the wrong way round after assembly.	▶ Contact specialist dealer. Check installation correct.
Hub has axial clearance	Ball bearings are worn.	▶ Contact specialist dealer. Replace ball bearings.
	One or both toothed discs are fitted the wrong way round after assembly.	▶ Contact specialist dealer. Check installation correct.
Hub is stiff when turned	Ball bearings are worn.	▶ Contact specialist dealer. Replace ball bearings.
	Ball bearings have been driven in too firmly after assembly	▶ Contact specialist dealer. Check installation correct.
	Installation sequence for ball bearings not observed.	▶ Contact specialist dealer. Check installation correct.
Hub makes noise	Ball bearings are worn	▶ Contact specialist dealer. Replace ball bearings.
Cassette caused notches on the freewheel body	Steel cassette works its way into the aluminium bar on the freewheel body.	▶ Contact specialist dealer. Remove notches on the cassette surface with a file.
Freewheel body is stiff when turned	Ball bearings in the freewheel body are worn.	▶ Contact specialist dealer. Replace freewheel body.
Freewheel is too loud or too quiet	Perception of freewheel noise is subjective. While some pedelec riders prefer loud freewheel noise, others like a quite freewheel more.	▶ This is not a malfunction. The amount of grease between the toothed discs may have an effect on the freewheel noise. Less grease increases freewheel noise but also causes greater wear.

Table 82: Error solution for freewheel

9.2.8 Problem with SR SUNTOUR suspension fork

9.2.8.1 Rebound too fast

The suspension fork rebounds too quickly, producing a "pogo stick" effect, where the wheel lifts from the ground in an uncontrolled way. This impairs traction and control (blue line).

Fork head and handlebars are deflected upwards if the wheel bounces back from the ground. Body weight may be thrown up and back in an uncontrolled way (green line).



Figure 219: Suspension fork rebounding too quickly

Solution

► Turn **rebound screw** in a clockwise direction.

⇒ The rebound speed is decreased (slower return).

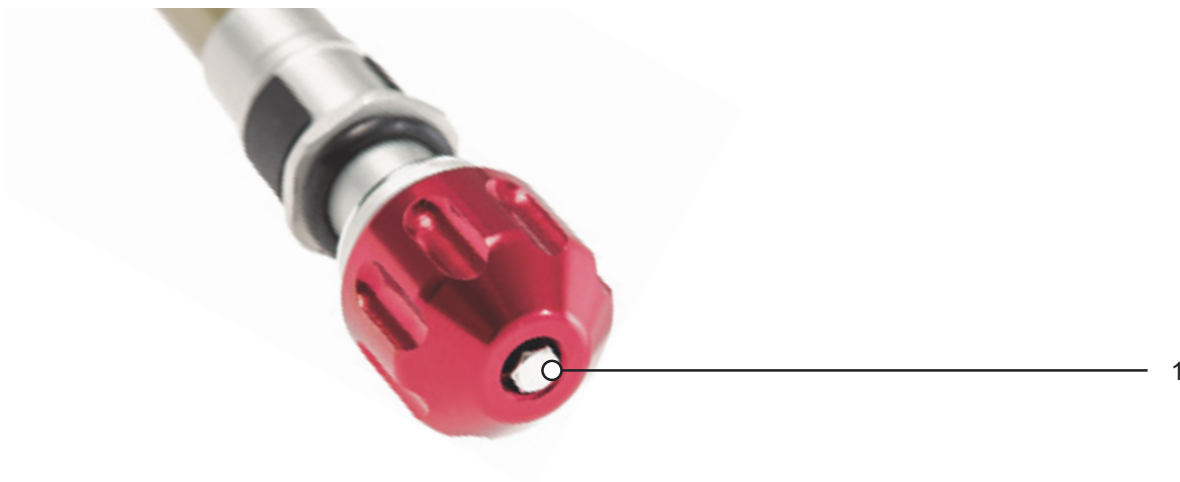

Figure 220: Example of SR SUNTOUR rebound screw (1)

9.2.8.2 Rebounding too slowly

The fork does not rebound quickly enough after absorbing a bump. The fork also remains deflected over subsequent bumps, which reduces deflection and increases the hardness of impacts. Available deflection, traction and control decrease (blue line).

The fork remains in a deflected state, causing the headset and handlebars to move to a lower position. Body weight is shifted forward after the impact (green line).

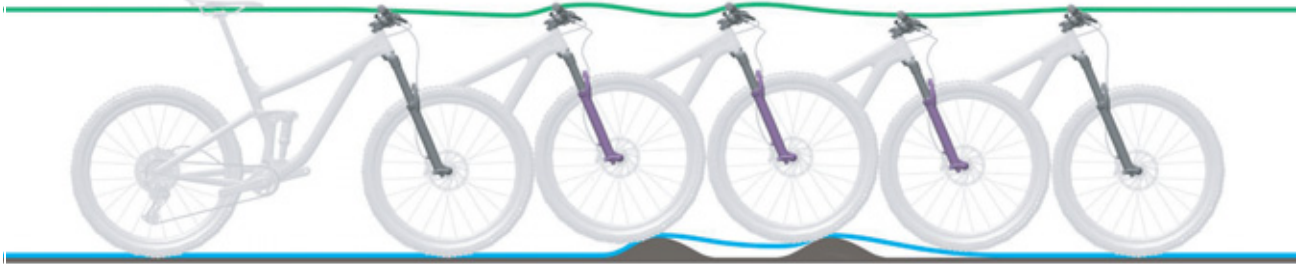

Figure 221: Suspension fork rebounding too slowly

Solution

► Turn **rebound screw** in an anti-clockwise direction.

⇒ The rebound speed is increased (faster return).

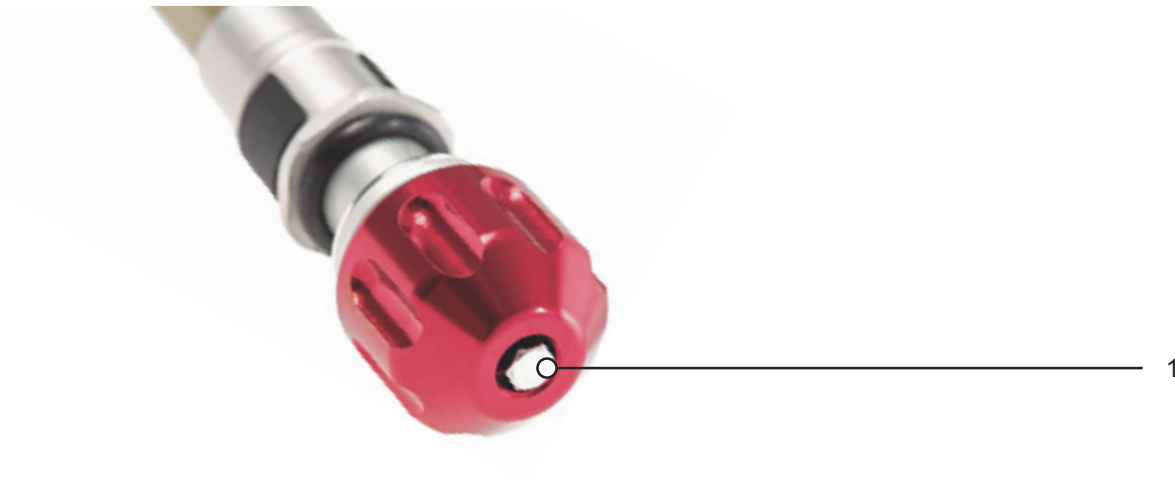

Figure 222: Example of SR SUNTOUR rebound screw (1)

9.2.8.3 Suspension too soft on inclines

The fork deflects at a low point in the terrain. The deflection is quickly used up, body weight shifts forward and the pedelec loses some momentum.

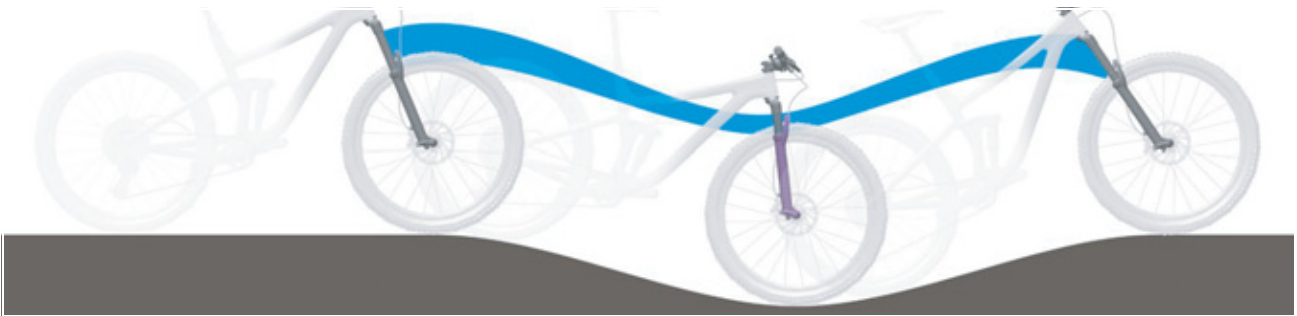

Figure 223: Excessively soft suspension in the suspension fork on hilly terrain

Solution

- Turn **compression lever** clockwise towards **LOCK**.

⇒ The damping and compression hardness are increased and the deflection stroke speed. Efficiency on hilly and flat terrain is improved.



R2C2-PCS R2C2 RC2 RC2-PCS	RC-PCS RC	RLRC-PCS RLRC	LORC-PCS LORC
			

Table 83: Low-speed lever (1) on the SR Suntour suspension fork on the fork crown

9.2.8.4 Excessively hard damping on bumps

When the bike hits a bump, the fork deflects too slowly and the wheel lifts up from the bump. Traction decreases when the wheel no longer touches the ground.

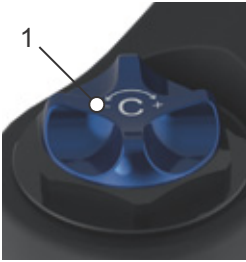
The headset and handlebars are deflected upwards significantly, which can impair control.

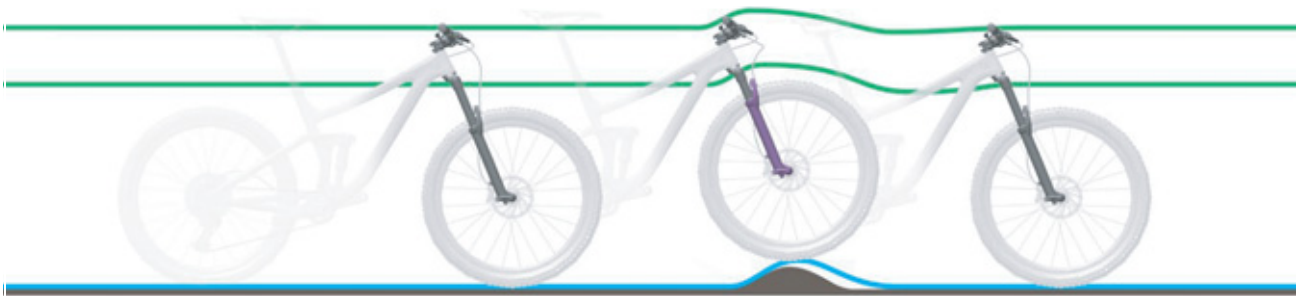

Figure 224: Excessively hard damping in the suspension fork on bumps

Solution

► Turn **compression lever** clockwise towards OPEN.

⇒ The damping and compression hardness reduces and the deflection stroke speed is reduced. Sensitivity to small bumps is increased.

R2C2-PCS R2C2 RC2 RC2-PCS	RC-PCS RC	RLRC-PCS RLRC	LORC-PCS LORC

Table 84: Low-speed lever (1) on the SR Suntour suspension fork on the fork crown

9.2.9 Problems with SR SUNTOUR rear frame damper

9.2.9.1 Rebound too fast

The rear frame damper rebounds too quickly, producing a "pogo stick" effect or causing the bike to bounce after the wheel hits a bump and lands on the ground again. This impairs traction and control due to the uncontrolled speed at which the rear frame damper rebounds after deflecting (blue line).

Saddle and handlebars are deflected upwards when the wheel bounces back from the ground. The rider's body weight may be shifted upwards and forwards if the rear frame damper fully rebounds too quickly (green line).



Figure 225: Rear frame damper rebounding too quickly

Solution

- ▶ Turn **rebound adjuster wheel** towards plus. ⇒ The deflection movement is reduced.

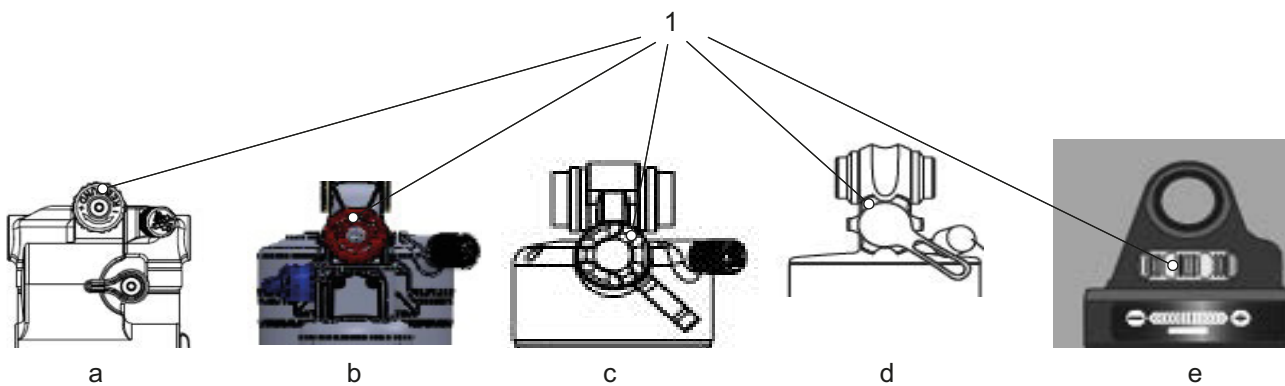

Figure 226: Position of RS Suntour rebound adjuster wheel for rear frame dampers Triair2 (a), Triair (b), EDGE-comp (c), EDGE (d) and RAIDON (e)

9.2.9.2 Rebounding too slowly

The rear frame damper does not rebound quickly enough after a bump has been compensated and is not in the required initial position when the wheel hits the next bump. The rear frame damper remains compressed during successive bumps, thus reducing deflection and ground contact and increasing hardness on the next impact. The rear wheel bounces off the second bump since the rear frame damper does not rebound quickly enough to make contact with the ground and return to the initial position again. The available deflection and traction are reduced (blue line).

The rear frame damper remains in a deflected state after contact with the first bump. When the rear wheel hits the second bump, the saddle follows the path of the rear wheel instead of remaining in a horizontal position. The available deflection and potential absorption of bumps are reduced, which causes instability and loss of control during successive bumps (green line).



Figure 227: Rear frame damper rebounding too slowly

Solution

- ▶ Turn **rebound adjuster wheel** towards minus. ⇒ The rebound movement is increased.

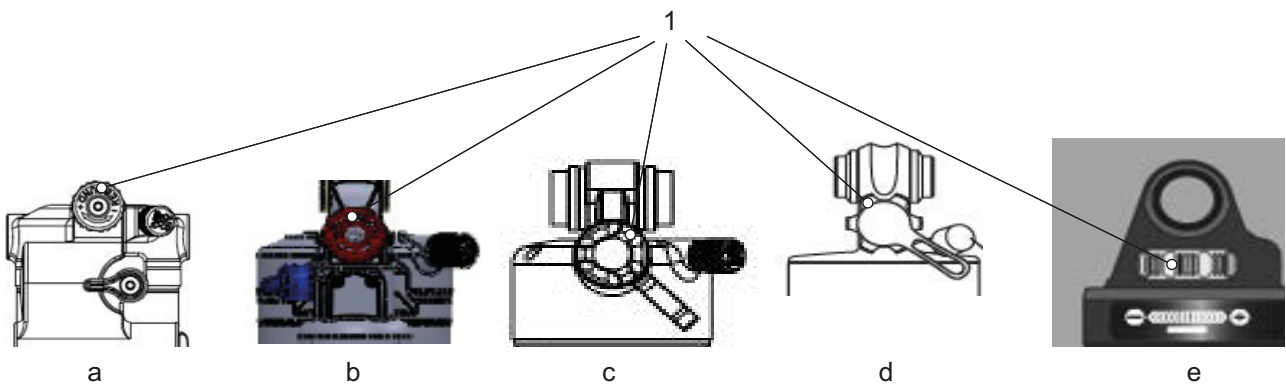

Figure 228: Position of RS Suntour rebound adjuster wheel for rear frame dampers Triair2 (a), Triair (b), EDGE-comp (c), EDGE (d) and RAIDON (e)

9.2.9.3 Suspension too soft on inclines

The rear frame damper deflects deeply through the deflection range. The deflection is quickly

used up, body weight shifts downwards and the pedelec loses some momentum.



Figure 229: Excessively soft suspension in the rear frame damper on hilly terrain

Solution

► Turn **compression level** clockwise.

⇒ The damping and compression hardness is increased, and the deflection stroke speed is reduced. Efficiency on hilly and flat terrain is improved.

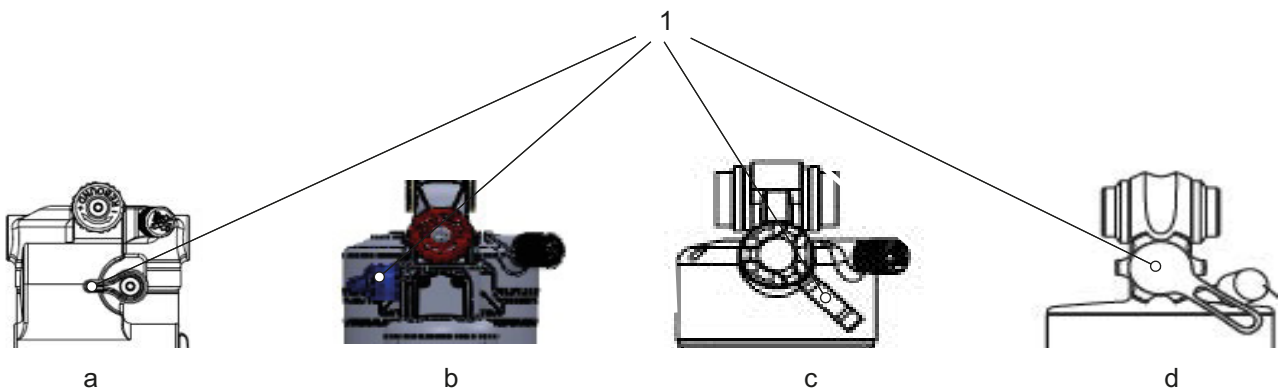

Figure 230: Position of RS Suntour compression lever for rear frame dampers Triair2 (a), Triair (b), EDGE-comp (c) and EDGE (d)

9.2.9.4 Excessively hard damping on bumps

When the bike hits a bump, the damper deflects too slowly and the rear wheel lifts up from the bump. Traction is reduced (blue line).

Saddle and pedelec rider are deflected upwards and forwards, the rear wheel loses contact with the ground and control is reduced (green line).



Figure 231: Excessively hard damping in the rear frame damper on bumps

Solution

► Turn **compression lever** anti-clockwise.

⇒ The damping and compression hardness is reduced and the deflection stroke speed

is increased. Sensitivity to small bumps is increased.

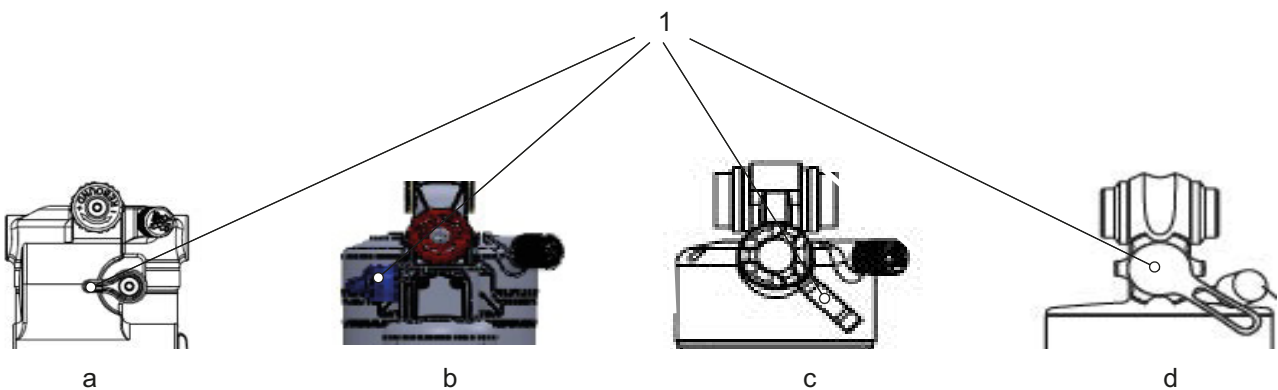

Figure 232: Position of RS Suntour compression lever for rear frame dampers Triair2 (a), Triair (b), EDGE-comp (c) and EDGE (d)

9.2.10 Lighting does not work

Symptom	Cause	Remedy
The front light or rear light does not go on, even when the switch is pressed.	The default settings in the electric drive system have probably been configured incorrectly. The light is defective.	<ol style="list-style-type: none"> 1 Take pedelec out of service immediately. 2 Contact specialist dealer.

Table 85: Lighting error solution

9.2.11 Problems with the tyres

Symptom	Cause	Remedy
Valve torn off.	Presta valve used with a sizeable valve hole. The hole's metal edge separates the valve stem from the tube.	▶ Contact specialist dealer. Fit another type of valve.

Table 86: Fault solution for tyres

9.2.12 Problems with the seat post

Symptom	Cause	Remedy
Seat post clicks or creaks.	Protective layer missing.	Maintain seat post.
Seat post deflects and bobs periodically.	Incorrect preload.	Adjust preload so that the suspension seat post does not compress under the rider's weight when at rest.
Seat post with remote control does not rise or lower.	Bowden cable is not tensioned correctly.	<p>▶ Adjust the Bowden cable with the setting screw (1) on the remote control</p>  <p>Figure 233: Remote control with setting screw (1)</p> <ul style="list-style-type: none"> • Reduce sensitivity: turn setting screw clockwise. • Increase sensitivity: turn setting screw anti-clockwise.

Table 87: Fault solution for the seat post

9.3 Other errors

Symptom	Cause	Remedy
Two beeps will sound if a switch is pressed but the switch cannot be operated.	Pressed switch mode has been deactivated.	▶ This is not a malfunction.
Three beeps are sounded.	A fault or warning has occurred.	▶ This occurs when a warning or an error is shown on the on-board computer. Follow the instructions for the code in Section 6.2 System Messages.
If an electronic gear shift is used, pedal assistance becomes less effective when the gear is changed.	This is because the computer sets the pedal assistance to the optimum level.	▶ This is not a malfunction.
A noise can be heard after switching.		▶ Contact specialist dealer.
It is normal to hear a noise coming from the rear wheel when cycling as normal.	The gear shift setting may not have been made properly.	▶ Contact specialist dealer.
If the pedelec is brought to a stop the pedelec, the gear transmission does not switch to the position pre-configured in the functional feature.	You may have applied too much pressure on the pedals.	▶ Press on the pedals only gently to make it easier to change the transmission.

Table 88: Other drive system errors

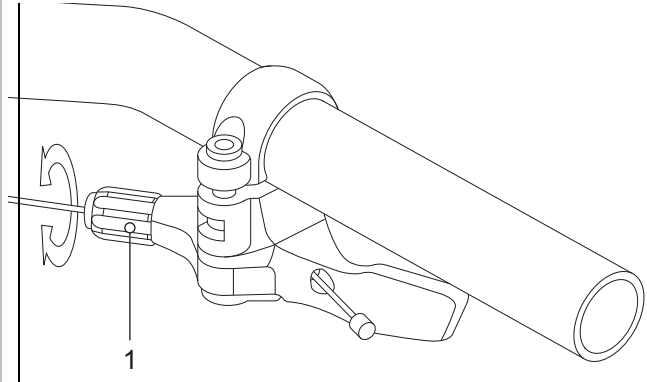

9.4 Repair

Special expertise and tools are required for many repairs. For this reason, repairs may only be carried out at a specialist dealer. These include:

- Replacing tyre, tube and spokes
- Replace brake linings, rims and brake discs
- Replace and tension the chain.

9.4.1 Original parts and lubricants

The individual pedelec parts have been carefully selected and matched to one other.

Only original parts and lubricants must be used for inspection and repair.

The constantly updated accessory approval and parts lists are in Section 11, Documents and Drawings.

- ▶ Follow the operating instructions for the new components.

9.4.2 Repairing the frame

9.4.2.1 Removing paint damage on frame

- 1 Gently sand paintwork damage with 600-grit sandpaper.
- 2 Smooth edges.
- 3 Apply one or two coats of repair paint.

9.4.2.2 Removing damage from impact on the carbon frame

There may be damage to the laminate beneath the paintwork in the case of impact. The frame may break even under light stress.

- 1 Take pedelec out of service.
- 2 Send frame to a fibre composite repair company or purchase new frame as specified in the parts list.

9.4.3 Repairing the suspension fork

9.4.3.1 Removing paint damage on the fork

- 1 Gently sand paintwork damage with 600-grit sandpaper.
- 2 Smooth edges.
- 3 Apply one or two coats of repair paint.

9.4.3.2 Removing damage from impact on the carbon frame

There may be damage to the laminate beneath the paintwork in the case of impact. The fork may break even under light stress.

- ▶ Take pedelec out of service. New fork as specified in the parts list.
- ⇒ The fork must be free from any defects.
- 4 Clean inside and exterior.
- 5 Grease fork.
- 6 Install fork.

9.4.3.3 Repairing the seat post

Repairing paint damage on the seat post

- 1 Gently sand paintwork damage with 600-grit sandpaper.
- 2 Smooth edges.
- 3 Apply one or two coats of repair paint.

9.4.3.4 Repairing damage from impact on the carbon seat post

There may be damage to the laminate beneath the paintwork in the case of impact. The carbon seat post may break even under light stress.

- 1 Take pedelec out of service.
- 2 New carbon seat post as specified in parts list.



9.4.4 Replacing the riding light

- ▶ Only use components in the corresponding power class for replacement.

9.4.5 Adjusting the headlight

- ▶ The *headlight* must be positioned so that its light beam shines on the road 10 m in front of the pedelec (see Section 6.4).

9.4.6 Checking suspension fork-tyre clearance

The tyre clearance needs to be checked each time a suspension fork tyre is replaced.

- 1 Release pressure from the fork.
- 2 Press fork together fully.
- 3 Measure the gap between the top of the tyre and the fork crown's lower surface. The gap must not be less than 10 mm. If the tyre is too large, the tyre will touch the fork crown's lower surface when the fork is fully pressed together.
- 4 Release pressure on fork and pump it up again if it is an air suspension fork.
- 5 Take into account the fact that the gap will be smaller if there is a guard. Check again to ensure that there is sufficient clearance for the tyre.

9.4.7 Replacing pedelec components if lock function is installed

9.4.7.1 Replacing a smartphone

- 1 Install Bosch eBike connect app on the new smartphone.
 - 2 Log on using the same account which was used to activate the lock function.
 - 3 Connect on-board computer with the smartphone while the on-board computer is in use.
- ⇒ The lock function is shown as set up in the BOSCH eBike Connect app.

9.4.7.2 Replacing the on-board computer

- Connect on-board computer with the smartphone while the on-board computer is in use.
- ⇒ The lock function is shown as set up in the BOSCH eBike Connect app.

9.4.7.3 Activating the lock function after motor replacement

- ✓ The lock function is displayed as deactivated in the eBike Connect app when the motor has been replaced.
- 1 Open the <My eBike> menu item in the eBike Connect app.
 - 2 Push the <Lock function> slider to the right.
- ⇒ The drive unit assistance can now be deactivated by removing the on-board computer.

10 Recycling and disposal



This device is marked according to the European Directive 2012/19/EU on waste electrical and electronic equipment – WEEE and the European



Directive 2006/66/EC on accumulators. The directive provides the framework for the return and recycling of used devices

across the EU. Consumers are legally required to return all used batteries of any type. It is forbidden to dispose of batteries in domestic waste.

The battery manufacturer is legally obliged to take back used and old batteries free of charge according to Section 9 German Batteries Act. The pedelec frame, battery, motor, on-board computer and charger are recyclable materials. You must dispose of and recycle them separately from the domestic waste in compliance with applicable statutory regulations. Separate collection and

recycling saves reserves of raw materials and ensures that all the regulations for protection of health and the environment are adhered to when recycling the product and/or the battery.

- ▶ Never dismantle the pedelec, battery or charger for disposal.

The pedelec, on-board computer, the unopened and undamaged battery and the charger can be returned to any specialist dealer free of charge. Further disposal options may be available, depending on the region.

- ▶ Store the individual parts of the decommissioned pedelec in a dry place, free from frost, where they are protected from direct sunlight.

10.1 Guidelines on removal of waste

Waste type	Disposal
Non-hazardous waste	
Recycling	
Waste paper, cardboard	Return paper collection bin, paper container, undamaged transport packaging to suppliers
Scrap metal and aluminium	Take to municipal collection points or have collected by waste disposal companies
Tyres, tubes	Tyre manufacturers' collection points, collection forms and fax templates available from tyre manufacturer Otherwise, residual waste bin (grey bin)
Fibre composite components (e.g. carbon, GRP)	Large carbon components such as defective frames and carbon rims can be sent to special collection points for recycling; see www.cfk-recycling.de/index.php?id=57
Dual system sales packaging made of plastic, metal and composite material, lightweight packaging	Collection by waste disposal firm where applicable; return transport packaging to suppliers Plastic waste bin (yellow bin)
CDs, DVDs	Take to municipal collection points since they are made of high-grade plastic and are easy to recycle Otherwise, residual waste bin (grey bin)

Table 89: Removal of waste guidelines

Waste type	Disposal
Dispose of	
Residual waste	Residual waste bin (grey bin)
Biodegradable lubricants Biodegradable oils Cleaning cloths covered in biodegradable oil	Residual waste bin (grey bin)
Filament lamps, halogen lamps	Residual waste bin (grey bin)
Hazardous waste	
 Recycling	
Batteries, rechargeable batteries	Return to the battery manufacturer.
Electric devices: Motor On-board computer Display Control panel Wiring	Take to a municipal collection point for electronic waste
Dispose of	
Waste oil Cleaning cloths daubed in oil Lubrication oil Gear oil Lubricating grease Cleaning fluids Kerosene White spirit Hydraulic fluid Brake fluid	<p>Never mix different oil fluids. Store in original container</p> <p>Small amounts (mainly <30 kg) Take to municipal collection points for hazardous waste (e.g. mobile toxic waste collection service)</p> <p>Larger quantities (>30 kg) Collection by waste disposal companies</p>
Paints Varnishes Thinners	Take to municipal collection points for hazardous waste (e.g. mobile toxic waste collection service)
Neon lights, energy-saving lamps	Take to municipal collection points for hazardous waste (e.g. mobile toxic waste collection service)

Table 89: Removal of waste guidelines



11 Documents

11.1 Assembly report

Date:

Frame number:

Components	Description	Tests	Criteria		Measures if rejected
			Acceptance	Rejection	
Front wheel	Assembly		O.K.	Loose	Adjust quick release
Kickstands	Check mount fastening	Functional check	O.K.	Loose	Retighten screws
Tyres		Tyre pressure check	O.K.	Tyre pressure too low/ too high	Adjust tyre pressure
Frame	Check for damage – fracture, scratches		O.K.	Damage detected	<i>Take out of operation, new frame</i>
Handles, coverings	Check mount fastening		O.K.	Not provided	Retighten screws, new handles and coverings as specified in parts list
Handlebars, stem	Check mount fastening		O.K.	Loose	Retighten screws; new stem as specified in parts list if necessary
Steering headset	Check for damage	Functional check	O.K.	Loose	Retighten screws
Saddle	Check mount fastening		O.K.	Loose	Retighten screws
Seat post	Check mount fastening		O.K.	Loose	Retighten screws
Guard	Check mount fastening		O.K.	Loose	Retighten screws
Pannier rack	Check mount fastening		O.K.	Loose	Retighten screws
Attachments	Check mount fastening		O.K.	Loose	Retighten screws
Bell		Functional check	O.K.	No ring, too quiet, missing	New bell as specified in the parts list
Suspension elements					
Fork, suspension fork	Check for damage		O.K.	Damage detected	New fork as specified in the parts list
Rear frame damper	Check for damage		O.K.	Damage detected	New fork as specified in the parts list
Suspension seat post	Check for damage		O.K.	Damage detected	New fork as specified in the parts list
Brake system					
Handbrake	Check mount fastening		O.K.	Loose	Retighten screws
Brake fluid	Check fluid level		O.K.	Too little	Refill with brake fluid; new brake hoses if damaged
Brake linings	Check brake linings, brake discs and rims for damage		O.K.	Damage detected	New brake linings, brake discs and rims
Back-pedal brake braking armature	Check mount fastening		O.K.	Loose	Retighten screws
Lighting system					
Rechargeable battery	First examination		O.K.	Error message	<i>Take out of service</i> ; contact battery manufacturer, new battery
Light cabling	Connections, correct wiring		O.K.	Cable defective, no light	New cabling
Rear light	Side light	Functional check	O.K.	No constant light	<i>Take out of service</i> ; new rear light as specified in parts list; replace if necessary
Front light	Side light, daytime riding light	Functional check	O.K.	No constant light	<i>Take out of service</i> ; new front light as specified in parts list; replace if necessary
Reflectors	All complete, state, fastening		O.K.	Damaged or not all complete	New reflectors



Drive/gear shift					
Chain/cassette/pinion/chaining	Check for damage		O.K.	Damage	Refasten if necessary or replace as specified in parts list
Chain guard/spoke guard	Check for damage		O.K.	Damage	Replace as specified in parts list
Bottom bracket axle/crank	Check mount fastening		O.K.	Loose	Retighten screws
Pedals	Check mount fastening		O.K.	Loose	Retighten screws
Shifter	Check mount fastening	Functional check	O.K.	Loose	Retighten screws
Shift cables	Check for damage	Functional check	O.K.	Loose and defective	Adjust shift cables; new shift cables if necessary
Front derailleur	Check for damage	Functional check	O.K.	Switching gears difficult or not possible	Adjust
Rear derailleur	Check for damage	Functional check	O.K.	Switching gears difficult or not possible	Adjust
Electric drive					
On-board computer	Check for damage	Functional check	O.K.	No screen, defective screen display	Restart, test battery, new software or new on-board computer; <i>take out of service</i>
Control panel	Check control panel for damage	Functional check	O.K.	No response	Restart; contact control panel manufacturer, new control panel
Tachometer		Speed measurement	O.K.	Pedelec travelling 10% too fast/slow	Take pedelec out of service until the source of the error is found
Cabling	Visual inspection		O.K.	Failure in system, damage, kinked cables	New cabling
Battery mount	Firmly in position, lock, contacts	Functional check	O.K.	Loose; lock doesn't close, no contacts	New battery mount
Motor	Visual inspection and mount		O.K.	Damage, loose	Refasten motor, contact motor manufacturer, new motor
Software	Check version		In latest version	Not latest version	Import update

Technical inspection, checking safety, test ride

Components	Description		Criteria		Measures if rejected
	Assembly/inspection	Tests	Acceptance	Rejection	
Brake system		Functional check	O.K.	No full braking; braking distance too long	Locate defective part in brake system and correct
Gear shift under operating load		Functional check	O.K.	Problems when shifting gear	Readjust gear shift
Suspension components (fork, shock absorber, seat post)		Functional check	O.K.	Suspension too deep or no longer exists	Locate defective component and correct
Electric drive system		Functional check	O.K.	Loose connection, problems when riding, accelerate	Locate faulty components in electric drive and remedy
Lighting system		Functional check	O.K.	No continuous light, not bright enough	Locate defective part in lighting system and correct
Test ride			No strange noises	Strange noises	Locate source of noise and correct

Date:	
Fitter's name:	
Final inspection by workshop manager:	



11.2 Inspection and maintenance log

Diagnosis and documentation of current status

Date:

Frame number:

Component	Frequency	Description			Criteria		Measures if rejected
		Inspection	Test		Acceptance	Rejection	
Front wheel	6 months	Assembly			O.K.	Loose	Adjust quick release
Kickstands	6 months	Check mount fastening	Functional check		O.K.	Loose	Retighten screws
Tyres	6 months		Tyre pressure check		O.K.	Tyre pressure too low/ too high	Adjust tyre pressure
Frame	6 months	Check for damage – fracture, scratches			O.K.	Damage detected	Take pedelec out of service, new frame
Handles, coverings	6 months	Wear; check if fastened securely			O.K.	Not provided	Retighten screws, new handles and coverings as specified in parts list
Handlebars, stem	6 months	Check mount fastening			O.K.	Loose	Retighten screws; new stem as specified in parts list if necessary
Steering headset	6 months	Check for damage	Functional check	Lubricating and adjustment	O.K.	Loose	Retighten screws
Saddle	6 months	Check mount fastening			O.K.	Loose	Retighten screws
Seat post	6 months	Check mount fastening			O.K.	Loose	Retighten screws
Guard	6 months	Check mount fastening			O.K.	Loose	Retighten screws
Pannier rack	6 months	Check mount fastening			O.K.	Loose	Retighten screws
Attachments	6 months	Check mount fastening			O.K.	Loose	Retighten screws
Bell	6 months		Functional check		O.K.	No ring, too quiet, missing	New bell as specified in the parts list
Suspension elements							
Fork, suspension fork	To manufacturer's specifications*	Check for damage, corrosion, fracture		Maintenance as specified by manufacturer Lubrication, oil change as specified by manufacturer	O.K.	Damage detected	New fork as specified in the parts list
Rear frame damper	To manufacturer's specifications*	Check for damage, corrosion, fracture		Maintenance as specified by manufacturer Lubrication, oil change as specified by manufacturer	O.K.	Damage detected	New fork as specified in the parts list
Suspension seat post	To manufacturer's specifications*	Check for damage		Maintenance as specified by manufacturer	O.K.	Damage detected	New fork as specified in the parts list



		Inspection	Test		Acceptance	Rejection	
Brake system							
Handbrake	6 months	Check mount fastening			O.K.	Loose	Retighten screws
Brake fluid	6 months	Check fluid level		Depending on time of year	O.K.	Too little	Top up brake fluid; take Pedelec out of service if damaged; new brake hoses
Brake linings	6 months	Check brake linings, brake discs and rims for damage			O.K.	Damage detected	New brake linings, brake discs and rims
Back-pedal brake braking armature	6 months	Check mount fastening			O.K.	Loose	Retighten screws
Brake system	6 months	Check mount fastening		Functional check	O.K.	Loose	Retighten screws
Lighting system							
Rechargeable battery	6 months	First examination			O.K.	Error message	Contact battery manufacturer; take battery out of use; new battery
Light cabling	6 months	Connections, correct wiring			O.K.	Cable defective, no light	New cabling
Rear light	6 months	Side light	Functional check		O.K.	No constant light	New rear light as specified in parts list; replace if necessary
Headlight	6 months	Side light, daytime riding light	Functional check		O.K.	No constant light	New headlight light as specified in parts list; replace if necessary
Reflectors	6 months	All complete, state, fastening			O.K.	Damaged or not all complete	New reflectors
Drive/gear shift							
Chain/cassette/pinion/chainring	6 months	Check for damage			O.K.	Damage	Refasten if necessary or replace as specified in parts list
Chain guard/spoke guard	6 months	Check for damage			O.K.	Damage	Replace as specified in parts list
Bottom bracket axle/crank	6 months	Check mount fastening			O.K.	Loose	Retighten screws
Pedals	6 months	Check mount fastening			O.K.	Loose	Retighten screws
Shifter	6 months	Check mount fastening	Functional check		O.K.	Loose	Retighten screws
Shift cables	6 months	Check for damage	Functional check		O.K.	Loose and defective	Adjust shift cables; new shift cables if necessary
Front derailleur	6 months	Check for damage	Functional check		O.K.	Switching gears difficult or not possible	Adjust
Rear derailleur	6 months	Check for damage	Functional check		O.K.	Switching gears difficult or not possible	Adjust



		Inspection	Test		Acceptance	Rejection	
Electric drive system							
On-board computer	6 months	Check for damage	Functional check		O.K.	No screen, defective screen display	Restart; test battery; new software or new on-board computer; remove from service
Control panel	6 months	Control panel Check for damage	Functional check		O.K.	No response	Restart; contact control panel manufacturer, new control panel
Tachometer	6 months		Speed measurement		O.K.	Pedelec travelling 10% too fast/slow	Take pedelec out of service until the source of the error is found
Cabling	6 months	Visual inspection			O.K.	Failure in system, damage, kinked cables	New cabling
Battery mount	6 months	Firmly in position, lock, contacts	Functional check		O.K.	Loose; lock doesn't close, no contacts	New battery mount
Motor	6 months	Visual inspection and mount			O.K.	Damage, loose	Refasten motor, contact motor manufacturer, new motor; <i>take out of service</i>
Software	6 months	Check version			In latest version	Not latest version	Import update

Technical inspection, checking safety, test ride

Component	Frequency	Description			Criteria
		Inspection	Test		Acceptance
Brake system	6 months	Functional check	O.K.	No full braking; braking distance too long	Locate defective part in brake system and correct
Gear shift under operating load	6 months	Functional check	O.K.	Problems when shifting gear	Readjust gear shift
Suspension components (fork, shock absorber, seat post)	6 months	Functional check	O.K.	Suspension too deep or no longer exists	Locate defective component and correct
Electric drive	6 months	Functional check	O.K.	Loose connection, problems when riding, accelerate	Locate faulty component in electric drive and remedy
Lighting system	6 months	Functional check	O.K.	No continuous light, not bright enough	Locate defective part in lighting system and correct
Test ride	6 months	Functional check	No strange noises	Strange noises	Locate source of noise and correct

Date:	
Fitter's name:	
Final inspection by workshop manager:	



Notes

11.3 Parts list

11.3.1 Cross Rider Evo 1

23-15-2007, 23-15-2008, 23-15-2009
Gent, Trapez, Wave

Frame	Cross Rider EVO 1	Aluminium, welded, frame shape and size: Gent: 45 50 55 60 cm Trapez: 45 50 55 cm Wave: 45 50 55 cm
Rear frame damper
Tyres Front Rear	SCHWALBE, G-One Allround	Gravel tyres TLE, DD, RaceGuard EPI: 67 Profile: HS473 Folding tyres Weight: 760 g Size: 57-622 (29") Max. load: 120 kg Printing: 1.8... 3.7 bar (26... 54 psi) Max. load: 120 115 kg
Tube	SCHWALBE, SV19B Light 40 mm	Presta valve, valve length: 40 mm
Wheel
Rim	Bulls, DDM-2	Aluminium, 700C, 13G × 36H
Spoke Front Rear	...	Corrosion-resistant, 14G × 36H 13G × 36H
Spoke nipples Front Rear	...	Brass, 14G × 36H 13G × 36H
Front wheel hub	SHIMANO, ALIVIO HB-M4050QR	Front wheel hub, with centre lock, aluminium, with SHIMANO quick release (QR), 36H
Rear wheel hub	SHIMANO, ALIVIO FH-M4050	Aluminium, freewheel hub, with SHIMANO QR quick release, centre lock, 36H
Steering headset	FSA, NO, 57SC	Aluminium, Aheadset, tapered: 1.5", for fork steerer: 1-1/8", 8.4 mm
Stem	KALLOY, AS-ZG4	Aluminium, Ahead stem, adjustable, handlebars clamp diameter: Ø 31.8 mm Stem angle: +7° <u>Stem length (depends on frame size):</u> Gent: 45: 70 mm Gent: 50: 90 mm Gent: 55 60: 110 mm Wave: 45 50: 70 mm Wave: 55: 90 mm
Handlebars	KALLOY, HBHR101	Aluminium, Ø: 31.8 mm Height: 25 mm Backsweep: 5°/9° Vertical angle: 5° Length: Gent: 700 mm Wave: 680 mm
Handles Tapers Left hand Right hand	ERGON, GP1	Bio-leather, winged grip

Fork	SR SUNTOUR, XCM32-ATB DS NLO 29"	Steel suspension fork, offset: 44 mm Head tube: 1.5" to 1-1 8" Deflection: 100 mm Right-hand side: RL, LO, HLO Left-hand side: Steel suspension with adjustable preload Fork head: AC4C Stanchion distance: 130 mm Head tube: 1.5" ... 1-1 8" tapered (CTS), STKM Area of use: Casual MTB Stanchion length: 523 mm Axle: 9-100 mm dropout
Saddle	Bulls, 4007HRN	Unisex saddle Length: 266 mm Width: 178 mm
Seat post	STYX, SP-F102	Aluminium, patent seat post, 2D forged head, 6061-T6 Ø: 30.9 mm Length: 350 mm Offset: 7 mm
Saddle clamp	Bulls, XC68C	Aluminium, Ø: 34.9 mm
Pedal name	WELLGO, C098	Aluminium Plastic, basic pedal with anti-slip surface, W 9 16", with reflector
Crank set	FSA, CK-220	Aluminium, crank set, crank length: 170 mm, for BOSCH Gen3 motors
Chain belt	#	#
Chain wheel Belt sprocket	SAMOX, EMS05-BHV04	Steel, chain wheel, teeth: 44 T, 3 32" × 44T, for BOSCH GEN 4 motors, plastic chain guard
Chain guard	See 05.4 chain wheel	...
Chain guide
Motor	BOSCH, Performance Line CX (BDU3740)	See Section 3.6.7
On-board computer	BOSCH, LED Remote (BRC3600)	See Section 3.6.5
Display	BOSCH, Intuvia 100 (BHU3200) Display mount (BDS3YYY)	See Section 3.6.6 See Section 3.6.7
Control panel
Rechargeable battery	BOSCH, PowerTube 500 (BBP375Y) or PowerTube 625 (BBP376Y) or PowerTube 750 (BBP377Y)	See Section 3.6.8
Charger	BOSCH, 4A charger(BPC3400)	Charger, charging current (max.): 4 A
Brake lever Front Rear	SHIMANO, BL-MT201	Brake lever for hydraulic disc brake
Brake Front Rear	SHIMANO, BR-MT200	Hydraulic disc brake
Brake disc Front Rear	SHIMANO, RT-EM300	Steel, Ø 180 mm, centre lock mount
ABS
Shifter	SHIMANO, DEORE SL-M4100-I	Shifter, 2/1 × 10-speed
Rear derailleur	SHIMANO, DEORE RD-M5120-SGS	10 11-speed
Front derailleur
Ring gear	SHIMANO, DEORE CS-M4100	Cassette sprocket, 10-speed, teeth combination 11-42T: 11-13-15-18-21-24-28-32-37-42T
Spoke guard
Headlight	FUXON, FS-50 SL	LED with switch, with side light, with sensor, 6-12 V DC, max. 50 lx

Rear light	FUXON, RL-Mini-EB CLIP	6-12V DC
Reflectors Front Rear Wheel	... COMUS, CR-99 CATEYE, RR-317-WUA	... Z-reflector ...
Pannier rack, front
Pannier rack, rear
Guard Front Rear	SR SUNTOUR, FEG401	...
Kickstands	PLETSCHER, COMP Flex 40	...
Bell	NUVO, NH-405AP	Bell, aluminium
Mirror
Battery lock	ABUS, BLO BOSCH IT3 XPlus	2 keys
Chain lock
Bottle holder	FIDLOCK, BOTTLE CAGE	...
GPS BT

...not available

Information not available when document was produced

11.3.2 Iconic EVO 1

23-15-2017

Wave

Frame	Iconic EVO 1	Aluminium, welded, frame shape and size: Hydro Wave: 41/44/48/54 cm
Rear frame damper
Tyres Front Rear	SUPERO, CC-03, All Ground	Clincher Size: 27.5" × 2.45 (62-584) Pressure: max. 40-65 psi
Tube	SUPERO, F/V 40 mm	Schrader valve, valve length: 40 mm, for 584 × 62C tyres
Wheel
Rim	Bulls, DISC 30	Aluminium, 27.5" PLUS (ETRTO 584), 13G × 32H
Spoke Front Rear	...	Corrosion-resistant, 14G × 32H/13G × 32H
Spoke nipples Front Rear	...	Brass, 14G × 32H / 13G × 32H
Front wheel hub	SHIMANO, HB-MT200	Aluminium, quick release, with centre lock, with SHIMANO quick release (QR), 32H
Rear wheel hub	SHIMANO, FH-MT200-B	Aluminium, cassette hub, for disc brake, with SHIMANO QR quick release 141 mm, centre lock, 13G × 32H
Steering headset	FSA, No, 57B-1	Aluminium, Aheadset, conical, for fork steerer: 1-1/8", 16.2 mm
Stem	KALLOY, AS-4005	Aluminium, quill stem, adjustable, handlebars clamp diameter: Ø 31.8 mm Stem length (depends on frame size): 41/44/48: 65 mm 54: 80 mm
Handlebars	STYX, HBRB12L	Aluminium, Ø: 31.8 mm; height: 25 mm; backsweep: 9°; length: Gent: 740 mm/Wave: 720 mm
Handles Tapers Left hand Right hand	VELO ENTERPRISE, VLG-1879D2	Hard plastic, winged grips, ø 22.4 mm, 138/138 mm
Fork	SR SUNTOUR, NVX30 NLO DS 29"	Steel suspension fork Offset: 42 / 46 mm Head tube: 1-1/8" Deflection: 100 mm Right-hand side: RL/NLO Left-hand side: Steel suspension with adjustable preload Head tube 1-1/8 (TS), STKM Area of use: Cross Fork head: AC4C Axle: 9-100 mm dropout
Saddle	SELLE ROYAL & CHINA, 4007HRN	Unisex saddle, length: 266 mm; width: 178 mm
Seat post	LIMOTEC, A3, soft	Aluminium, lowerable, spring-loaded seat post Ø: 30.9 mm Deflection: 40 mm Lowerable length (depends on frame size): 41: 40 mm 44/48: 80 mm 54/60: 100 mm Length (depends on frame size): 41: 345 mm 44/48: 402 mm 54/60: 445 mm Max. bodyweight: 75 kg
Saddle clamp	Bulls, XC68C	Aluminium, Ø: 34.9 mm

Pedal name	WELLGO, C098	Aluminium/plastic, basic pedal with anti-slip surface, W/9/16", with reflector
Crank set	FSA, CK-220	Aluminium, crank set, crank length: 165 mm, for BOSCH Gen3 motors
Chain belt	#	#
Chain wheel Belt sprocket	#	#
Chain guard	Steel, chain wheel, teeth: 38 T, 3/32" x 38T, for BOSCH GEN 4 motors	SAMOX, EMS05-BHV04
Chain guide	Plastic, for BOSCH GEN 4 motors	...
Motor	BOSCH, Performance Line CX (BDU3740)	See Section 3.6.7
On-board computer	BOSCH, LED Remote (BRC3600)	See Section 3.6.5
Display	BOSCH, Intuvia 100 (BHU3200) Display mount (BDS3YYY)	See Section 3.6.6 See Section 3.6.7
Control panel
Rechargeable battery	BOSCH, PowerTube 500 (BBP375Y) or PowerTube 625 (BBP376Y) or PowerTube 750 (BBP377Y)	See Section 3.6.8
Charger	BOSCH, 4A charger(BPC3400)	Charger, charging current (max.): 4 A
Brake lever Front Rear	SHIMANO, BL-MT201	Brake lever for hydraulic disc brake
Brake Front Rear	SHIMANO, BR-MT200	Hydraulic disc brake
Brake disc Front Rear	SHIMANO, RT-EM300	Steel, Ø 180 mm, centre lock mount
ABS
Shifter	SHIMANO, DEORE SL-M4100-I	Shifter, 2/1 x 10-speed
Rear derailleur	SHIMANO, DEORE RD-M5120-SGS	10/11-speed
Front derailleur
Ring gear	SHIMANO, DEORE CS-M4100	Cassette sprocket, 10-speed, teeth combination 11-42T: 11-13-15-18-21-24-28-32-37-42T
Spoke guard
Headlight	FUXON, FS-50 SL	LED, 6-12 V/DC, max. 50 lx, with switch, with side light with sensor
Rear light	FUXON, R-GLOW	LED, 6-12 V DC, with Z-reflector
Reflectors Front Rear Wheel	.../COMUS, FZR-006/...	.../Z-reflector/...
Pannier rack, front
Pannier rack, rear	STANDWELL, SW-ML079	Aluminium, with MonkeyLoad system
Guard Front Rear	SKS, PET A60 S MK / U-STAY+2-PCS ESC	Plastic, 28"
Kickstands	STANDWELL, SW-RA060JD	Aluminium, screw gap: 40 mm
Bell	NUVO, NH-405AP	Bell, aluminium
Mirror
Battery lock	ABUS, BLO ZEG IT4 "EVO IV" X-PLUS	2 keys, with digital key card for ABUS lock

Chain lock
Bottle holder	FIDLOCK, BOTTLE CAGE	...
GPS BT

...not available

Information not available when document was produced

11.3.3 Iconic EVO 2

23-15-2018, 23-15-2019

Gent, Wave

Frame	Iconic EVO 2	Aluminium, welded, frame shape and size: Gent: 41/44/48/54/60 cm Wave: 41/44/48/54 cm
Rear frame damper
Tyres Front Rear	SUPERO, CC-03, All Ground	Clincher Size: 27.5" × 2.45 (62-584) Pressure: max. 40-65 psi
Tube	SUPERO, F/V 40 mm	Schrader valve, valve length: 40 mm, for 584 × 62C tyres
Wheel
Rim	Bulls, DISC 30	Aluminium, 27.5" PLUS (ETRTO 584), 13G × 32H
Spoke Front Rear	...	Corrosion-resistant, 14G × 32H/13G × 32H
Spoke nipples Front Rear	...	Brass, 14G × 32H / 13G × 32H
Front wheel hub	SHIMANO, HB-MT200	Aluminium, quick release, with centre lock, with SHIMANO quick release (QR), 32H
Rear wheel hub	SHIMANO, FH-MT200-B	Aluminium, cassette hub, for disc brake, with SHIMANO QR quick release 141 mm, centre lock, 13G × 32H
Steering headset	FSA, NO, 57SC	Aluminium, Aheadset, tapered: 1.5", for fork steerer: 1-1/8", 8.4 mm
Stem	KALLOY, AS-4005	Aluminium, quill stem, adjustable, handlebars clamp diameter: Ø 31.8 mm, stem length (depends on frame size): Frame size: 41/44/48: 65 mm, frame size: 54: 80 mm
Handlebars	STYX, HBRB12L	Aluminium, Ø: 31.8 mm; height: 25 mm; backsweep: 9°; length: Gent: 740 mm/Wave: 720 mm
Handles Tapers Left hand Right hand	VELO ENTERPRISE, VLG-1879D2	Hard plastic, winged grips, ø 22.4 mm, 138/138 mm
Fork	SR SUNTOUR, XCM32-ATB DS NLO 29"	Steel suspension fork Offset: 44 mm Head tube: 1.5" to 1-1/8" Deflection: 100 mm Right-hand side: RL, LO, HLO Left-hand side: Steel suspension with adjustable preload Fork head: AC4C Stanchion distance: 130 mm Head tube: 1.5" to 1-1/8" tapered (CTS), STKM Area of use: Casual MTB Stanchion length: 523 mm Axle: 9-100 mm dropout
Saddle	SELLE ROYAL & CHINA, 4007HRN	Unisex saddle, length: 266 mm; width: 178 mm

Seat post	LIMOTEC, A3, soft	Aluminium, lowerable, spring-loaded seat post Ø: 30.9 mm Deflection: 40 mm Lowerable length (depends on frame size): 41: 40 mm 44/48: 80 mm 54/60: 100 Length (depends on frame size): 41: 345 mm 44/48: 402 mm 54/60: 445 mm Max. bodyweight: 75 kg
Saddle clamp	Bulls, XC68C	Aluminium, Ø: 34.9 mm
Pedal name	WELLGO, C098	Aluminium/plastic, basic pedal with anti-slip surface, W/9/16", with reflector
Crank set	FSA, CK-220	Aluminium, crank set, crank length: 165 mm, for BOSCH Gen3 motors
Chain belt	#	#
Chain wheel Belt sprocket	#	#
Chain guard	Steel, chain wheel, teeth: 38 T, 3/32" × 38T, for BOSCH GEN 4 motors	SAMOX, EMS05-BHV04
Chain guide	Plastic, for BOSCH GEN 4 motors	...
Motor	BOSCH, Performance Line CX (BDU3740)	See Section 3.6.7
On-board computer	BOSCH, LED Remote (BRC3600)	See Section 3.6.5
Display	BOSCH, Intuvia 100 (BHU3200) Display mount (BDS3YYY)	See Section 3.6.6 See Section 3.6.7
Control panel
Rechargeable battery	BOSCH, PowerTube 500 (BBP375Y) or PowerTube 625 (BBP376Y) or PowerTube 750 (BBP377Y)	See Section 3.6.8
Charger	BOSCH, 4A charger(BPC3400)	Charger, charging current (max.): 4 A
Brake lever Front Rear	SHIMANO, BL-MT201	Brake lever for hydraulic disc brake
Brake Front Rear	SHIMANO, BR-MT200	Hydraulic disc brake
Brake disc Front Rear	SHIMANO, RT-EM300	Steel, Ø 180 mm, centre lock mount
ABS
Shifter	SHIMANO, DEORE SL-M5100-I	Shifter, 2/1 × 11-speed
Rear derailleur	SHIMANO, DEORE RD-M5100-SGS	11-gear
Front derailleur
Sprocket	SHIMANO, CS-M5100	Cassette sprocket, 11-speed Teeth combination (11-51T): 11-13-15-18-21-24-28-33-39-45-51T
Spoke guard	...	Plastic, 5-1/2"

Headlight	FUXON, FS-70EB	LED, 6-12 V, max. 70 lx, with sensor, with daytime riding light
Rear light	FUXON, R-GLOW	LED, 6–12 V DC, with Z-reflector
Reflectors Front Rear Wheel	.../COMUS, FZR-006/...	.../Z-reflector/...
Pannier rack, front
Pannier rack, rear	STANDWELL, SW-ML079	Aluminium, with MonkeyLoad system
Guard Front Rear	SKS, PET A60 S MK / U-STAY+2-PCS ESC	...
Kickstands	STANDWELL, SW-RA060JD	Aluminium, screw gap: 40 mm
Bell	NUVO, NH-405AP	Bell, aluminium
Mirror
Battery lock	ABUS, BLO ZEG IT4 "EVO IV" X-PLUS	2 keys, with digital key card for ABUS lock
Chain lock		...
Bottle holder	FIDLOCK, BOTTLE CAGE	...
GPS BT

...not available

Information not available when document was produced

11.3.4 Iconic EVO 3

23-15-2020, 23-15-2021

Gent, Wave

Frame	Iconic EVO 3	Aluminium, welded, frame shape and size: Gent: 41/44/48/54/60 cm Wave: 41/44/48/54 cm
Rear frame damper
Tyres Front Rear	SCHWALBE, Smart Sam	All-round tyres Tube, Performance EPI: 67 Profile: HS476 Clincher Weight: 850 g Size: 65-584 (27.5") Max. load: 115 kg Printing: 1.5-3.0 bar (20-45 psi)
Tube	SCHWALBE, SV21FB LIGHT, 40 mm	Presta valve, valve length: 40 mm
Wheel
Rim	Bulls, DISC 30	Aluminium, 27.5" PLUS (ETRTO 584), 13G x 32H
Spoke Front Rear	...	Corrosion-resistant, 14G x 32H/13G x 32H
Spoke nipples Front Rear	...	Brass, 14G x 32H / 13G x 32H
Front wheel hub	SHIMANO, ALTUS HB-MT400-B	Aluminium, front wheel hub, with centre lock, with E-Thru quick release axle (by fork manufacturer) 110 x 15 mm, 14G x 36H
Rear wheel hub	SHIMANO, FH-MT200-B	Aluminium, cassette hub, for disc brake, with SHIMANO QR quick release 141 mm, centre lock, 13G x 32H
Steering headset	FSA, NO, 55R/44 1.8"	Aluminium, Aheadset, conical, for fork steerer: 1-1/8", 21.4 mm
Stem	KALLOY, AS-SUV-i	Aluminium, Ahead stem, adjustable, handlebars clamp diameter: ? 31.8 mm, stem length (depends on frame size): : Frame size: 41/44/48: 70 mm, frame size: 54/60: 90 mm
Handlebars	KALLOY, HBHR101	Aluminium, Ø: 31.8 mm; height: 25 mm; backsweep: 5°/ 9°; vertical angle: 5°; length: 740 mm
Handles Tapers Left hand Right hand	VELO ENTERPRISE, VLG-1777D2	Hard plastic, winged grips, ø 22.4 mm, 131.6/131.6 mm
Fork	Bulls, Lytro, XCR-34 29"	Suspension fork Deflection: 120 mm Cartridge type: LORC-PCS Offset: 44/51 mm Head tube: 1-1/ 8" Right side: RL/LO/RLR/LOR Left side: air-suspended Stanchion distance: 145 mm Lockout operation on the fork crown
Saddle	SELLE ROYAL & CHINA, 4007HRN	Unisex saddle, length: 266 mm; width: 178 mm

Seat post	LIMOTEC, A3, soft	Aluminium, lowerable, spring-loaded seat post Ø: 30.9 mm Deflection: 40 mm Lowerable length (depends on frame size): 41: 40 mm 44/48: 80 mm 54/60: 100 mm Length (depends on frame size): 41: 345 mm 44/48: 402 mm 54/60: 445 mm Max. bodyweight: 75 kg
Saddle clamp	Bulls, XC68C	Aluminium, Ø: 34.9 mm
Pedal name	WELLGO, C098	Aluminium/plastic, basic pedal with anti-slip surface, W/9/16", with reflector
Crank set	FSA, CK-220	Aluminium, crank set, crank length: 165 mm, for BOSCH Gen3 motors
Chain belt	#	#
Chain wheel Belt sprocket	#	#
Chain guard	Steel, chain wheel, teeth: 38 T, 3/32" × 38T, for BOSCH GEN 4 motors, plastic chain guard	SAMOX, EMS05-BHV04
Chain guide		...
Motor	BOSCH, Performance Line CX (BDU3740)	See Section 3.6.7
On-board computer	BOSCH, LED Remote (BRC3600)	See Section 3.6.5
Display	BOSCH, Intuvia 100 (BHU3200) Display mount (BDS3YYY)	See Section 3.6.6 See Section 3.6.7
Control panel
Rechargeable battery	BOSCH, PowerTube 500 (BBP375Y) or PowerTube 625 (BBP376Y) or PowerTube 750 (BBP377Y)	See Section 3.6.8
Charger	BOSCH, 4A charger(BPC3400)	Charger, charging current (max.): 4 A
Brake lever Front Rear	SHIMANO, BL-M4100	Brake lever for hydraulic disc brake, 2-finger
Brake Front Rear	SHIMANO, BR-MT420/BR-MT410	Hydraulic disc brake, 4 pistons/2 pistons
Brake disc Front Rear	SHIMANO, RT-EM300	Steel, Ø 180 mm, centre lock mount
ABS
Shifter	SHIMANO, DEORE XT SL-M8130-IR (E-BIKE)	Shifter, without gear indicator, 11-speed
Rear derailleur	SHIMANO, DEORE XT RD-M8130-SGS	11-gear
Front derailleur
Sprocket	SHIMANO, CS-LG600-11 (E-BIKE)	Cassette sprocket, 11-speed Teeth combination (11-50T): 11-13-15-17-20-23-26-30-36-43-50T
Spoke guard	YUNG FANG, YF-FH68-36H	...

Headlight	FUXON, FS-70EB	LED, 6-12 V, max. 70 lx, with sensor, with daytime riding light
Rear light	FUXON, R-GLOW	LED, 6–12 V DC, with Z-reflector
Reflectors Front Rear Wheel	.../COMUS, FZR-006/...	.../Z-reflector/...
Pannier rack, front
Pannier rack, rear	STANDWELL, SW-ML038	Aluminium, welded, with MonkeyLoad system
Guard Front Rear	SKS, PET A60 S MK / U-STAY+2-PCS ESC	...
Kickstands	STANDWELL, SW-RA060JD	Aluminium, screw gap: 40 mm
Bell	NUVO, NH-405AP	Bell, aluminium
Mirror
Battery lock	ABUS, BLO ZEG IT4 "EVO IV" X-PLUS	2 keys, with digital key card for ABUS lock
Chain lock		...
Bottle holder	FIDLOCK, BOTTLE CAGE	...
GPS BT

...not available

Information not available when document was produced

11.3.5 Iconic EVO Belt

23-15-3027, 23-15-3037

Gent, Wave

Frame	Iconic EVO Belt	Aluminium, welded, frame shape and size: Gent: 41/44/48/54/60 cm Wave: 41/44/48/54 cm
Rear frame damper
Tyres Front Rear	SUPERO, CC-03, All Ground	Clincher Size: 27.5" × 2.45 (62-584) Pressure: max. 40-65 psi
Tube	SUPERO, F/V 40 mm	Schrader valve, valve length: 40 mm, for 584 × 62C tyres
Wheel
Rim	Bulls, DISC 30	Aluminium, 27.5" PLUS (ETRTO 584), 14G × 36H
Spoke Front Rear	.../XT344	Corrosion-resistant, 14G × 36H/13G-14G × 36H
Spoke nipples Front Rear	...	Brass, 14G × 36H
Front wheel hub	SHIMANO, HB-MT200	Aluminium, quick release, with centre lock, with SHIMANO quick release (QR), 32H
Rear wheel hub	SHIMANO, SHIMANO STEPS SG-C7000-5D	Gear hub, 5-speed, centre lock, 36H
Steering headset	FSA, No, 57B-1	Aluminium, Aheadset, conical, for fork steerer: 1-1/8", 16.2 mm
Stem	KALLOY, AS-4005	Aluminium, quill stem, adjustable, handlebars clamp diameter: Ø 31.8 mm Stem length (depends on frame size): 41/44/48: 65 mm 54: 80 mm
Handlebars	STYX, HBRB12L	Aluminium, Ø: 31.8 mm; height: 25 mm; backsweep: 9°; length: Gent: 740 mm/ Wave: 720 mm
Handles Tapers Left hand Right hand	VELO ENTERPRISE, VLG-1879D2	Hard plastic, winged grips, Ø 22.4 mm, 138/138 mm
Fork	SR SUNTOUR, NVX30 NLO DS 29"	Steel suspension fork Offset: 42 / 46 mm Head tube: 1-1/8" Deflection: 100 mm Right-hand side: RL/NLO Left-hand side: Steel suspension with adjustable preload Head tube 1-1/8 (TS), STKM Area of use: Cross Fork head: AC4C Axle: 9 ... 100 mm dropout
Saddle	SELLE ROYAL & CHINA, 4007HRN	Unisex saddle, length: 266 mm; width: 178 mm
Seat post	LIMOTEC, A3, soft	Aluminium, lowerable, spring-loaded seat post Ø: 30.9 mm Deflection: 40 mm Lowerable length (depends on frame size): 41: 40 mm 44/48: 80 mm 54/60: 100 mm Length (depends on frame size): 41: 345 mm 44/48: 402 mm 54/60: 445 mm Max. bodyweight: 75 kg
Saddle clamp	Bulls, XC68C	Aluminium, Ø: 34.9 mm

Pedal name	WELLGO, C098	Aluminium/plastic, basic pedal with anti-slip surface, W/9/16", with reflector
Crank set	FSA, CK-220	Aluminium, crank set, crank length: 165 mm, for BOSCH Gen3 motors
Chain belt	GATES, 122T CDX	Belt, polyurethane/carbon, pitch: 11, number of teeth: 122; length: 1342
Chain wheel Belt sprocket	Belt, polyurethane/carbon, pitch: 11, number of teeth: 122; length: 1342	GATES, CDX, BOSCH GEN4
Chain guard	Aluminium, belt sprocket, teeth: 38T, for BOSCH GEN4 motor	GATES, CDX, BOSCH GEN4
Chain guide	Plastic, for BOSCH GEN 4 motors	...
Motor	BOSCH, Performance Line CX (BDU3740)	See Section 3.6.7
On-board computer	BOSCH, LED Remote (BRC3600)	See Section 3.6.5
Display	BOSCH, Intuvia 100 (BHU3200) Display mount (BDS3YYY)	See Section 3.6.6 See Section 3.6.7
Control panel
Rechargeable battery	BOSCH, PowerTube 500 (BBP375Y) or PowerTube 625 (BBP376Y) or PowerTube 750 (BBP377Y)	See Section 3.6.8
Charger	BOSCH, 4A charger(BPC3400)	Charger, charging current (max.): 4 A
Brake lever Front Rear	SHIMANO, BL-MT201	Brake lever for hydraulic disc brake
Brake Front Rear	SHIMANO, BR-MT200	Hydraulic disc brake
Brake disc Front Rear	SHIMANO, RT-EM300	Steel, Ø 180 mm, centre lock mount
ABS
Shifter	SHIMANO, NEXUS SL-C7000-5	Twist grip gear, 5-speed
Rear derailleur	...	See shifting hub
Front derailleur
Sprocket	GATES, 32T SUREFIT 3-LOBE UNIFIED CDX	Stainless steel, rear belt sprocket For SureFit™ 3-Lobe Number of teeth: 32 Pitch: 11
Spoke guard
Headlight	FUXON, FS-50 SL	LED, 6-12 V/DC, max. 50 lx, with switch, with side light with sensor
Rear light	FUXON, R-GLOW	LED, 6-12 V DC, with Z-reflector
Reflectors Front Rear Wheel	.../COMUS, FZR-006/...	.../Z-reflector/...
Pannier rack, front
Pannier rack, rear	Bulls	Aluminium, welded, with MonkeyLoad system
Guard Front Rear	SKS, PET A60 S MK / U-STAY+2-PCS ESC	...
Kickstands	STANDWELL, SW-RA060JD	...
Bell	NUVO, NH-405AP	Bell, aluminium

Mirror
Battery lock	ABUS, BLO ZEG IT4 "EVO IV" X-PLUS	2 keys, with digital key card for ABUS lock
Chain lock		...
Bottle holder	FIDLOCK, BOTTLE CAGE	...
GPS BT

...not available

Information not available when document was produced

11.3.6 Iconic EVO TR1

23-15-2022

Frame	Iconic EVO TR1	Aluminium, welded, frame shape and size: Gent: 41/44/48/54 cm
Rear frame damper	SR SUNTOUR, EDGE LOR8 TRUNNION MOUNT	Air damper Installation length: 185 mm Deflection: 50 mm Function Rebound adjustment: Low-speed rebound with lockout 80% Damping: LOR8
Tyres Front Rear	SUPERO, CC-03, All Ground	Clincher Size: 7.5 × 2.45 (62-584) Pressure: max. 40-65 psi
Tube	SUPERO, F/V 40 mm	Schrader valve, valve length: 40 mm, for 584 × 62C tyres
Wheel
Rim	Bulls, DISC 30	Aluminium, 27.5" PLUS (ETRTO 584), 13G × 32H
Spoke Front Rear	...	Corrosion-resistant, 14G × 32H/13G × 32H
Spoke nipples Front Rear	...	Brass, 14G × 32H / 13G × 32H
Front wheel hub	SHIMANO, ALTUS HB-MT400-B	Aluminium, front wheel hub, with centre lock, with E-Thru quick release axle (by fork manufacturer) 110 × 15 mm, 14G × 36H
Rear wheel hub	SHIMANO, FH-MT400-B FORMULA, FTA-12E	Aluminium, cassette hub, for disc brake, centre lock, 13G × 32H Quick release axle: M12 × P1.5, 148 × 12 mm E-thru
Steering headset	FSA, NO, 55R/44 1.8"	Aluminium, Aheadset, conical, for fork steerer: 1-1/8", 21.4 mm
Stem	KALLOY, AS-SUV-i	Aluminium, Ahead stem, adjustable, handlebars clamp diameter: Ø 31.8 mm, stem length (depends on frame size): Frame size: 41/44/48: 70 mm, frame size: 54/60: 90 mm
Handlebars	KALLOY, HBHR101	Aluminium, Ø: 31.8 mm; height: 25 mm; backsweep: 5°/ 9°; vertical angle: 5°; length: 740 mm
Handles Tapers Left hand Right hand	VELO ENTERPRISE, VLG-1879D2	Hard plastic, winged grips, ø 22.4 mm, 138/138 mm
Fork	Bulls, Lytro 34 27.5"+	Suspension fork Cartridge type: LORC-PCS Right side: LOR Left side: air-suspended Deflection: 120 mm Offset: 44 mm Head tube: 1-1/ 8" Stanchion distance: 145 mm Head tube: 1.5" tapered With mini-spring, lockout operated on fork crown
Saddle	SELLE ROYAL & CHINA, 4007HRN	Unisex saddle, length: 266 mm; width: 178 mm

Seat post	LIMOTEC, A1	Aluminium, lowerable seat post Ø: 30.9 mm Lowerable length (depends on frame size): 41: 75 mm 44: 100 mm 48: 125 mm 55/60: 150 mm Length (depends on frame size): 41: 295 mm 44: 345 mm 48: 405 mm 55/66: 445 mm Max. bodyweight: 120 kg
Saddle clamp	Bulls, MLCC35	Aluminium, Ø: 35 mm
Pedal name	WELLGO, C098	Aluminium/plastic, basic pedal with anti-slip surface, W/9/16", with reflector
Crank set	FSA, CK-220	Aluminium, crank set, crank length: 165 mm, for BOSCH Gen3 motors
Chain belt	#	#
Chain wheel Belt sprocket	#	SAMOX, EMS05-BHV04
Chain guard	Steel, chain wheel, teeth: 38 T, 3/32" x 38T, for BOSCH GEN 4 motors, plastic chain guard	SAMOX, EMS05-BHV04
Chain guide		...
Motor	BOSCH, Performance Line CX (BDU3740)	See Section 3.6.7
On-board computer	BOSCH, LED Remote (BRC3600)	See Section 3.6.5
Display	BOSCH, Intuvia 100 (BHU3200) Display mount (BDS3YYY)	See Section 3.6.6 See Section 3.6.7
Control panel
Rechargeable battery	BOSCH, PowerTube 500 (BBP375Y) or PowerTube 625 (BBP376Y) or PowerTube 750 (BBP377Y)	See Section 3.6.8
Charger	BOSCH, 4A charger(BPC3400)	Charger, charging current (max.): 4 A
Brake lever Front Rear	SHIMANO, BL-M4100	Brake lever for hydraulic disc brake, 2-finger
Brake Front Rear	SHIMANO, BR-MT420/BR-MT410	Hydraulic disc brake, 4 pistons/2 pistons
Brake disc Front Rear	SHIMANO, RT-EM300	Steel, Ø 180 mm, centre lock mount
ABS
Shifter	SHIMANO, DEORE SL-M4100-I	Shifter, 2/1 x 10-speed
Rear derailleur	SHIMANO, DEORE RD-M5120-SGS	10/11-speed
Front derailleur
Sprocket	SHIMANO, DEORE CS-M4100	Cassette sprocket, 10-speed, teeth combination 11-46T: 11-13-15-18-21-24-28-32-37-46T
Spoke guard
Headlight	FUXON, FF-100EB	6-12 V/DC, max. 100 lx, with sensor, with daytime riding light
Rear light	FUXON, R-GLOW	LED, 6-12 V DC, with Z-reflector
Reflectors Front Rear Wheel	.../COMUS, FZR-006/...	.../Z-reflector/...

Pannier rack, front
Pannier rack, rear	Bulls	Aluminium, welded, with MonkeyLoad system
Guard Front Rear	SKS, PET A60 S MK / U-STAY+2-PCS ESC	...
Kickstands	PLETSCHER, COMP Flex 40	...
Bell	NUVO, NH-405AP	Bell, aluminium
Mirror
Battery lock	ABUS, BLO ZEG IT4 "EVO IV" X-PLUS	2 keys, with digital key card for ABUS lock
Chain lock		...
Bottle holder	FIDLOCK, BOTTLE CAGE	...
GPS BT

...not available

Information not available when document was produced

11.4 Charger operating instructions

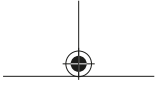

Charger

BPC3400

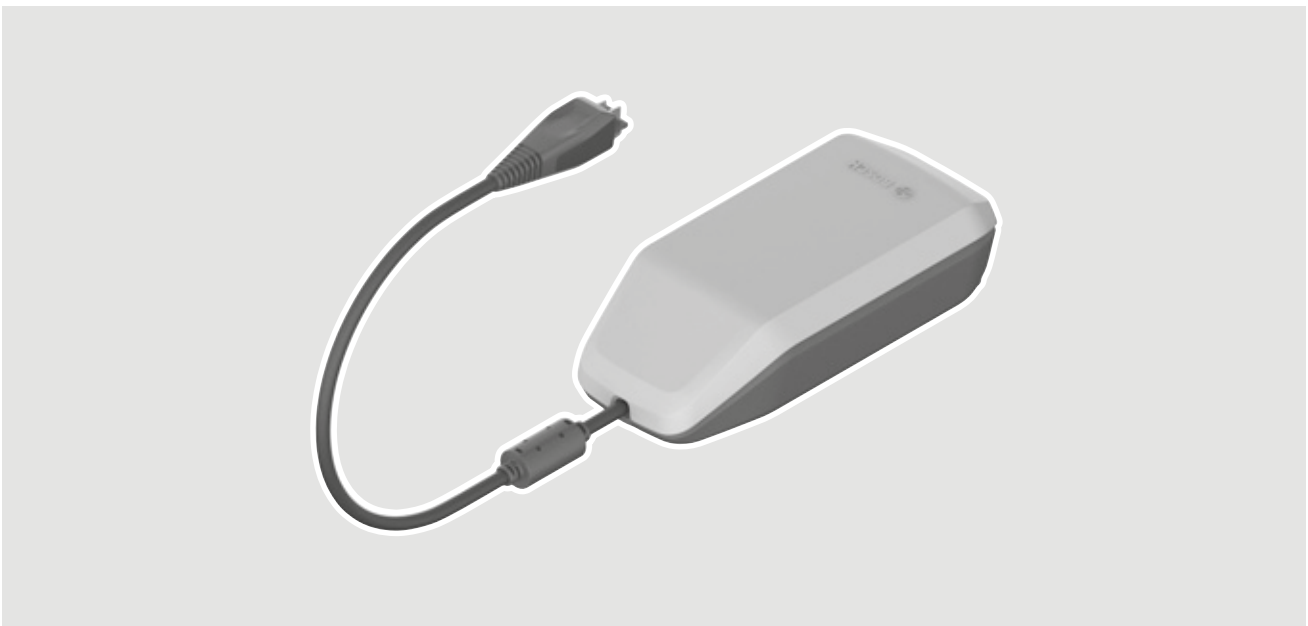

en Original operating instructions



2 |

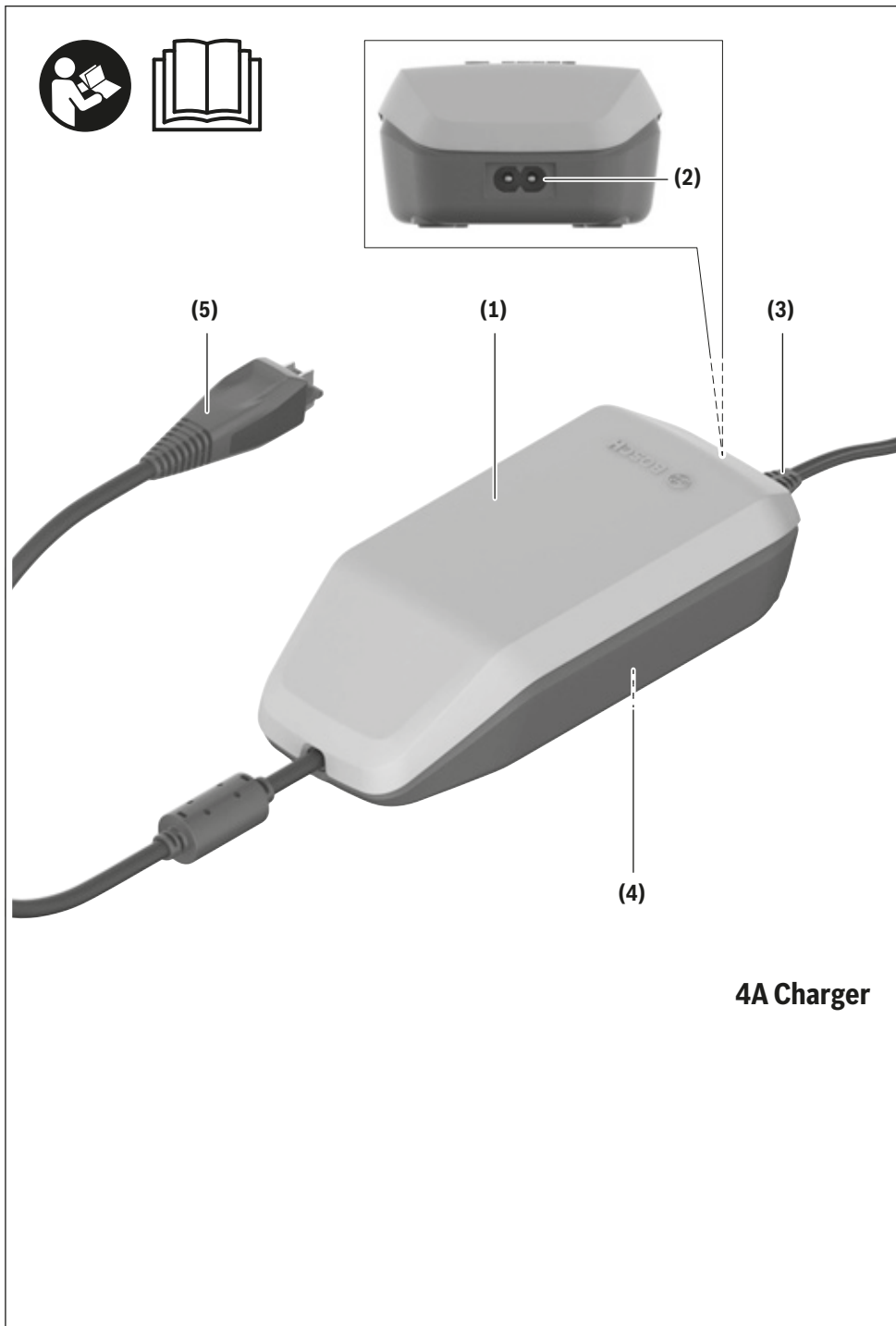

0 275 007 3CX | (09.06.2021)

Bosch eBike Systems

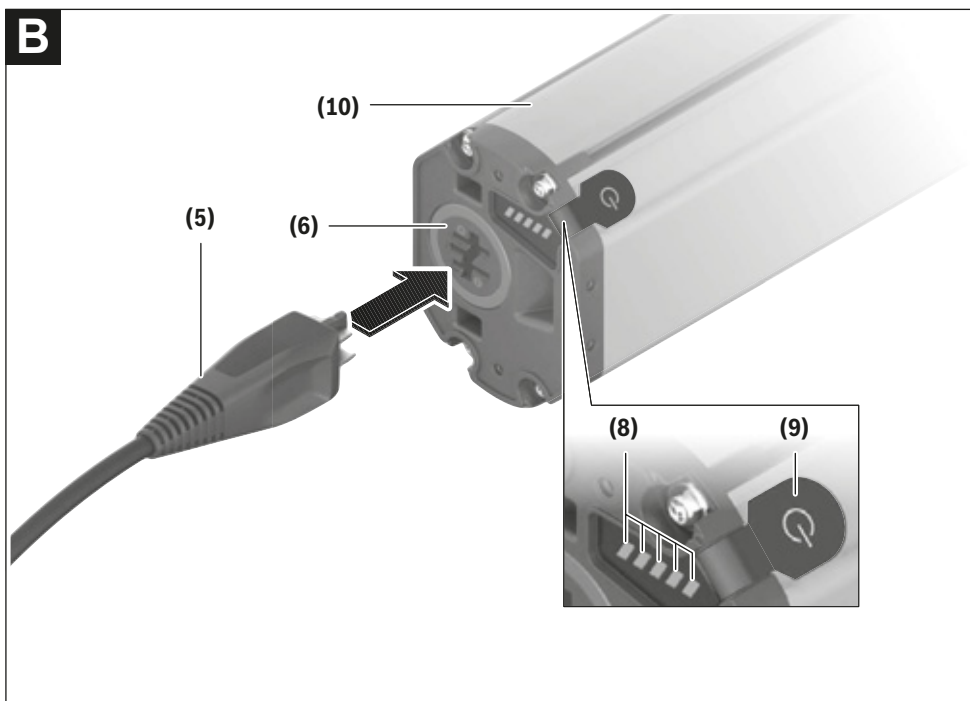
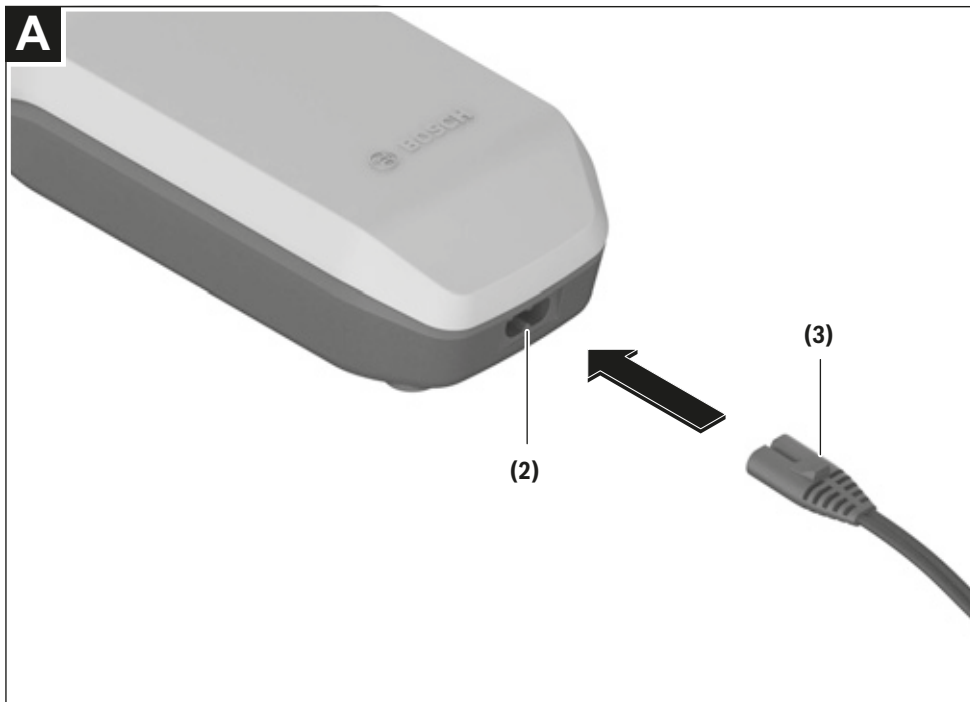

4 |

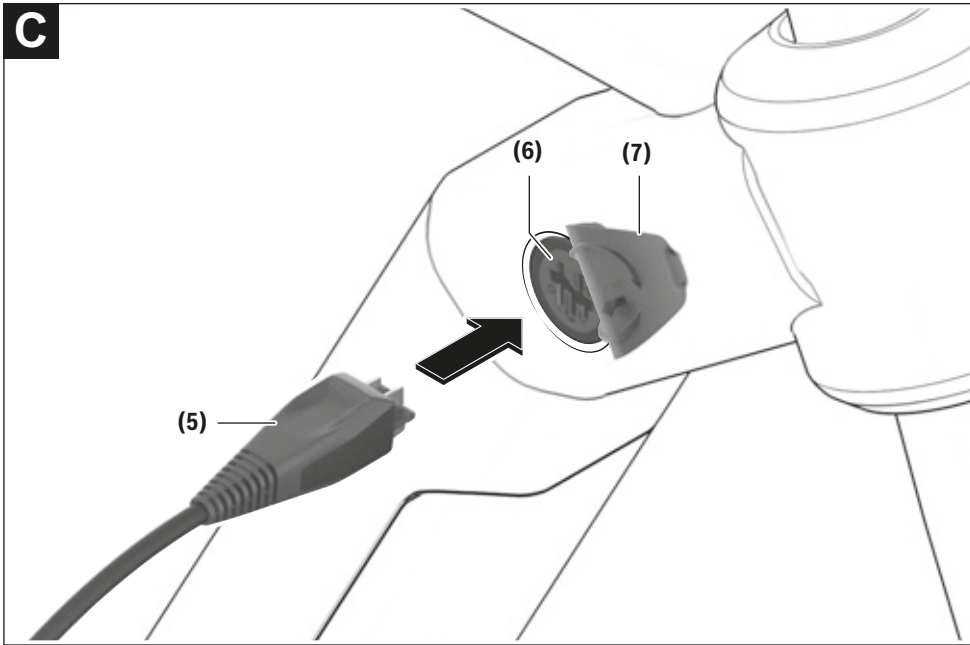

Safety instructions



Read all the safety and general instructions. Failure to observe the safety and general instructions may result in electric shock, fire and/or serious injury.

Save all safety warnings and instructions for future reference.

The term **battery** is used in these instructions to mean all original Bosch eBike rechargeable battery packs.



Do not expose the charger to rain or wet conditions. If water enters a charger, there is a risk of electric shock.

- ▶ **Charge only Bosch lithium-ion batteries that are approved for use in eBikes. The battery voltage must match the battery charging voltage of the charger.** Otherwise there is a danger of fire and explosion.
- ▶ **Keep the charger clean.** Dirt poses a risk of electric shock.
- ▶ **Always check the charger, cable and plug before use. Stop using the charger if you discover any damage. Do not open the charger.** Damaged chargers, cables and plugs increase the risk of electric shock.
- ▶ **Do not operate the charger on an easily ignited surface (e.g. paper, textiles, etc.) or in a flammable environment.** There is a risk of fire due to the charger heating up during operation.

onment. There is a risk of fire due to the charger heating up during operation.

- ▶ **Take care if you touch the charger while it is charging. Wear protective gloves.** The charger can get very hot, especially when the ambient temperature is high.
- ▶ **The battery may give off fumes if it becomes damaged or is used incorrectly. Ensure the area is well ventilated and seek medical attention should you experience any adverse effects.** The fumes may irritate the respiratory system.
- ▶ **The eBike battery must not be left unattended while charging.**
- ▶ **Supervise children during use, cleaning and maintenance.** This will ensure that children do not play with the charger.
- ▶ **Children or persons who, owing to their physical, sensory or mental limitations or to their lack of experience or knowledge, are not capable of safely operating the charger may only use this charger under supervision or after having been instructed by a responsible person.** Otherwise, there is a danger of operating errors and injuries.
- ▶ **Read and observe the safety warnings and directions contained in all the eBike system operating instructions and in the operating instructions of your eBike.**
- ▶ A sticker in English is adhered to the bottom of the charger (marked **(4)** in the diagram on the graphics page). This says:

Use ONLY with BOSCH lithium-ion rechargeable batteries!

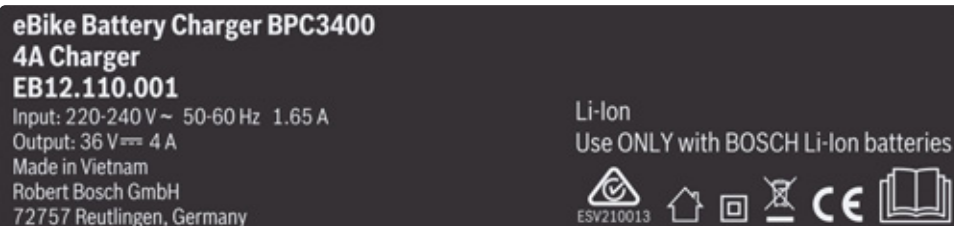

Product description and specifications

Intended Use

In addition to the functions shown here, changes to software relating to troubleshooting and functional modifications may be introduced at any time.

The Bosch eBike chargers are intended exclusively for charging Bosch eBike batteries and must not be used for any other purpose.

Product features

The numbering of the components shown refers to the illustrations on the graphics pages at the beginning of the manual.

Individual illustrations in these operating instructions may differ slightly from the actual conditions depending on the equipment of your eBike.

- (1) Battery charger
- (2) Device socket
- (3) Device connector
- (4) Charger safety instructions
- (5) Charging connector
- (6) Socket for charging connector
- (7) Charging socket cover
- (8) Operation/battery charge indicator
- (9) Battery on/off button
- (10) PowerTube

English – 2

Technical data

Charger	4A Charger	
Product code		BPC3400
Rated voltage	V~	198 to 264
Frequency	Hz	47 to 63
Battery charging voltage	V=	36
Charging current (max.)	A	4
Charging time for PowerTube 750, approx.	h	6
Operating temperature	°C	0 to 40
Storage temperature	°C	10 to 40
Weight, approx.	kg	0.7
Protection rating		IP40

The specifications apply to a rated voltage [U] of 230 V. These specifications may vary at different voltages and in country-specific models.

UK
CA

Operation

Start-up

Connecting the charger to the mains (see figure A)

- **Pay attention to the mains voltage.** The voltage of the power source must match the voltage specified on the rating plate of the charger. Chargers marked 230 V can also be operated at 220 V.

Plug the device connector (3) of the power cable into the device socket (2) on the charger.

Connect the power cable (country-specific) to the mains.

Charging the removed battery (see figure B)

Switch the battery off and remove it from its holder on the eBike. When doing so, read and observe the operating instructions of the battery.

- **Ensure the battery is placed on clean surfaces only.** Avoid getting dirt, e.g. sand or soil, in the charging socket and contacts in particular.

Plug the charging connector (5) of the charger into the socket (6) on the battery.

Charging the battery on the bike (see figure C)

Switch the battery off. Clean the cover of the charging socket (7). Avoid getting dirt, e.g. sand or soil, in the charging

socket and contacts in particular. Lift the cover of the charging socket (7) and plug the charging connector (5) into the charging socket (6).

- **There is a risk of fire due to the charger heating up during charging. Ensure the battery on the bike is completely dry and placed on a fireproof surface before charging.** If this is not possible, remove the battery from the holder and charge it in a more suitable location. When doing so, read and observe the operating instructions of the battery.

Charging process

The charging process begins as soon as the charger is connected to the battery or charging socket on the bike and to the mains.

Note: The charging process is only possible when the temperature of the eBike battery is within the permitted charging temperature range.

Note: The drive unit is deactivated during the charging process.

The battery can be charged with and without the on-board computer. When charging without the on-board computer, the charging procedure can be observed on the battery charge indicator.

When the on-board computer is connected, a charging notification appears on the display.

The state of charge is displayed by the battery charge indicator (8) on the battery and by the bars on the on-board computer.

The LEDs on the battery charge indicator (8) flash during the charging process. Each solid illuminated LED represents approximately 20 % of the charging capacity. The flashing LED indicates the next 20 % currently charging.

Once the eBike battery is fully charged, the LEDs go out immediately and the on-board computer is switched off. The charging process is terminated. The state of charge can be displayed for 5 seconds by pressing the on/off button (9) on the eBike battery.



Disconnect the charger from the mains and the battery from the charger.

When the battery is disconnected from the charger, the battery is automatically switched off.

Note: If you have charged the battery on the bike, carefully close the charging socket (6) with the cover (7) after charging, so that no dirt or water can get in.

If the charger is not disconnected from the battery after charging, after a few hours the charger will switch itself back on, check the state of charge of the battery and begin the charging procedure again if necessary.

Errors – causes and corrective measures

Cause	Corrective measures
 <p>Battery defective</p>	<p>Two LEDs flash on the battery.</p> <p>Contact an authorised bike dealership.</p>
 <p>Battery too warm or too cold</p>	<p>Three LEDs flash on the battery.</p> <p>Disconnect the battery from the charger until the charging temperature range has been reached.</p> <p>Do not reconnect the battery to the charger until it has reached the correct charging temperature.</p>
 <p>The charger is not charging.</p>	<p>No LEDs flashing (one or more LEDs will remain permanently lit depending on the state of charge of the eBike battery).</p> <p>Contact an authorised bike dealership.</p>
Charging not possible (no indicator on battery)	
Connector not attached properly	Check all connections.
Battery contacts dirty	Carefully clean the battery contacts.
Plug socket, cable or charger defective	Check the mains voltage, have the charger checked over by a bike dealership.
Battery defective	Contact an authorised bike dealership.

Maintenance and servicing

Maintenance and cleaning

If the charger fails, please contact an authorised bike dealership.

After-sales service and advice on using products

If you have any questions about the eBike system and its components, contact an authorised bicycle dealer.

For contact details of authorised bike dealerships, please visit www.bosch-ebike.com.

Disposal

Chargers, accessories and packaging should be recycled in an environmentally friendly manner.

Do not dispose of chargers along with household waste.

Only for EU countries:



According to the European Directive 2012/19/EU on Waste Electrical and Electronic Equipment and its implementation into national law, chargers that are no longer usable must be collected separately and disposed of in an environmentally friendly manner.

Subject to change without notice.

12 Glossary

Wear

Source: DIN 31051: reduction in useful life (4.3.4), caused by chemical and/or physical processes.

Shut-off speed

Source: EN 15194:2017: speed reached, by the pedelec, at the moment the current has dropped to zero or to the no load current value.

Rechargeable battery, battery

Source: DIN 40729:1985-05: a rechargeable battery is an energy storage device that can store supplied electrical energy as chemical energy (charging) and release it as electrical energy when required (discharging).

Drive belt

Source: EN 15194:2017: seamless ring belt which is used as a means of transmitting drive force.

Work environment

Source: ISO 9000:2015: set of conditions under which work is performed.

Decommissioning

Source: DIN 31051: intentional, unlimited interruption in an object's functional capability.

Year of manufacture

Source: ZEG: the year of manufacture is the year in which the pedelec was manufactured. The production period is always from May to July the following year.

Operating instructions

Source: ISO/DIS 20607:2018: part of the user information that machine manufacturers provide to machine operators; it contains guidance, instructions and tips related to the use of the machine in all its life cycle phases.

Brake lever

Source: EN 15194:2017: lever used to apply the brake.

Braking distance

Source: EN 15194:2017: distance travelled by a pedelec between the commencement of braking and the point at which the pedelec comes to rest.

Fracture

Source: EN 15194:2017: unintentional separation into two or more parts.

CE marking

Source: Directive on Machinery: the manufacturer uses the CE marking to declare that the pedelec complies with the applicable requirements.

City and trekking bicycle

Source: EN-ISO 4210 - 2: pedelec designed for use on public roads primarily for means of transportation or leisure.

Pressure point

Source: ZEG the pressure point on a brake is the point on the brake lever where the brake disc and brake pads respond and the braking process is initiated.

Electrical control system

Source: EN 15194:2017: electronic and/or electrical component or an assembly of components provided for installation into a vehicle, together with all electrical connections and associated wiring for the motor electrical power assistance.

Electrically power assisted cycle, pedelec

Source: EN 15194:2017: electrically power assisted cycle pedelec EPAC bicycles, equipped with pedals and an auxiliary electric motor, which cannot be propelled exclusively by means of the auxiliary electric motor, except in start-up assistance mode.

Spare part

Source: EN 13306:2018-02, 3.5: item intended to replace a corresponding item in order to retain or maintain the original required function of the item.

Folding bicycle

Source: ISO 4210-2: pedelec designed to fold into a compact form, making it easy to transport and store.

Fault

Source: EN 13306:2018-02, 6.1: state of an item (4.2.1) characterized by its inability to perform a required function (4.5.1), excluding such inability during preventive maintenance or other scheduled actions or due to lack of external resources.

Fork steerer

Source: EN 15194:2017: part of a fork that rotates around the steering axis of a pedelec frame head tube. It is normally connected to the fork crown or directly to the fork legs, and is normally the point of connection between the fork and the handlebar stem.

Suspension fork

Source: EN 15194:2017: front wheel fork incorporating controlled, axial flexibility to reduce the transmission of road-shocks to the rider.

Suspension frame

Source: EN 15194:2017: frame incorporating controlled, vertical flexibility to reduce the transmission of road-shocks to the rider.

Mountain bike, MTB

Source: ISO 4210 - 2: pedelec designed for use off-road on rough terrain, on public roads, and on public pathways, equipped with a suitably strengthened frame and other components, and, typically, with wide-section tyres with coarse tread patterns and a wide range of transmission gears.

Total deflection

Source: Benny Wilbers, Werner Koch: Neue Fahrwerkstechnik im Detail (New chassis technology in detail): The distance that the wheel travels between an unloaded and a loaded position is called total deflection. When at rest, the vehicle's mass is applied to the springs and reduces the total deflection by the *negative deflection* to the positive deflection.

Weight of the ready-to-ride pedelec

Source: ZEG: the indicated weight for a ready-to-ride pedelec refers to the weight of a pedelec at the time of sale. The weight of each additional accessory must be added to this weight

Manufacturer

Source: Directive 2006/42/EC on Machinery, 17.05.2006 Any natural or legal person who designs and/or manufactures machinery or partly completed machinery covered by this Directive and is responsible for the conformity of the machinery or the partly completed machinery with this Directive with a view to its being placed on the market, under his own name or trademark or for his own use.

Maximum permitted total weight

Source: EN 15194:2017: weight of the fully assembled pedelec plus the rider and baggage, as specified by the manufacturer.

Placing on the market

Source: Directive 2006/42/EC on Machinery, 17.05.2006, Making available for the first time in the Community machinery or partly completed machinery with a view to distribution or use, whether for reward or free of charge.

Bicycle for young adults

Source: ISO 4210-2: pedelec designed for use on public roads by a young adult whose weight is less than 40 kg, with maximum saddle height of 635 mm or more and less than 750 mm (see ISO 4210).

Cargo bike

Source: DIN 79010: pedelec mainly designed to carry goods.

Wheel

Source: ISO 4210 - 2: unit or combination of hub, rim and spokes or disc, but excluding tyre assembly.

Minimum insertion depth

Source: EN 15194:2017: mark indicating the minimum insertion depth of handlebar stem into fork steerer (fork stem) or seat post into frame.

Maximum continuous power rating

Source: ZEG: the maximum continuous power rating is the maximum power for the electric motor output shaft during 30 minutes.

Maximum saddle height

Source: EN 15194:2017: vertical distance from the ground to the point where the top of the seat surface is intersected by the seat-post axis, measured with the saddle in a horizontal position and with the seat-post set to the minimum insertion-depth mark.

Maximum tyre pressure

Source: EN 15194:2017: maximum tyre pressure recommended by the tyre or rim manufacturer for a safe and efficient performance. If the rim and tyre both indicate a maximum tyre pressure, the maximum inflation pressure is the lower of the two pressures indicated.

Model year

Source: ZEG: the model year refers to the first production year that the series-manufactured pedelec was manufactured in the version in question and is not always identical with the year of manufacture. The year of manufacture may be before the model year in some cases. If no technical modifications are introduced to the series, production may continue of pedelecs from a previous model year.

Continuous power rating

Source: ISO 15194:2017, output power specified by the manufacturer at which the motor reaches its thermal equilibrium under the specified ambient conditions.

Negative deflection

Negative deflection or sag is fork compression caused by body weight and gear (e.g. a backpack), the rider's position and the frame geometry.

Emergency stop

Source: ISO 13850:2015, function or signal, designed: — to avert arising or reduce existing hazards to persons, damage to machinery or to work in progress; – to be initiated by a single human action.

Racing bicycle

Source: ISO 4210-2: bicycle intended for high-speed amateur use on public roads and having a steering assembly with multiple grip positions (allowing for an aerodynamic posture), a multi-speed transmission system, tyre width not greater than 28 mm and a maximum mass of 12 kg for the fully assembled bicycle.

Seat post

Source: EN 15194:2017: component that clamps the saddle (with a bolt or assembly) and connects it to the frame.

Slippage

Source: DIN 75204-1:1992-05: the difference in relation to vehicle speed between the vehicle speed and the speed of its wheels at their circumference.

Disc brake

Source: EN 15194:2017: brake in which brake pads are used to grip the lateral faces of a thin disc attached to or incorporated into the wheel hub.

Quick-release device, quick release

Source: EN 15194:2017: lever actuated mechanism that connects, retains or secures a wheel or any other component.

Off-road rough terrain

Source: EN 15194:2017: rough gravel tracks, forest trails and other generally off-road tracks where tree roots and rocks are likely to be encountered.

Consumables

Source: EN 82079-1: any part or material that is needed to continue using or maintain the product.

Maintenance

Source: DIN 31051: maintenance is generally performed at regular intervals and often carried out by trained technical staff. This ensures a maximum service life and low wear and tear for the maintained items. Proper maintenance is often also a pre-requisite for providing a warranty.

Rebound

The rebound defines the speed at which the fork rebounds after being loaded.

12.1 Abbreviations

Abbreviation	Meaning/derivation
ABS	Anti-blocking system
EPAC	Electric power assisted cycle
PTW	Permitted total weight

Table 90: Table of abbreviations

12.2 Simplified terms

The following terms are used for better legibility:

Term	Meaning
Operating instructions	Original operating instructions
Damper	Rear frame damper
Specialist dealer	Bicycle specialist dealer
Motor	Drive motor, sub-system
Belt drive	Toothed belt drive

Table 91: Table of simplified terms

13 Appendix

I. Translation of the original EC/EU Declaration of Conformity

Manufacturer

ZEG Zweirad-Einkaufs-Genossenschaft eG
 Longericher Str. 2
 50739 Köln, Germany

Authorised representative for documentation*

Janine Otto
 c/o ZEG Zweirad-Einkaufs-Genossenschaft eG
 Longericher Str. 2
 50739 Köln, Germany

The machine, pedelec types:

23-15-2007	Cross Rider EVO 1 (Gent)	City and trekking bicycle
23-15-2008	Cross Rider EVO 1 (Trapez)	City and trekking bicycle
23-15-2009	Cross Rider EVO 1 (Wave)	City and trekking bicycle
23-15-2016	Iconic EVO 1 27.5" (Gent)	City and trekking bicycle
23-15-2017	Iconic EVO 1 27.5" (Wave)	City and trekking bicycle
23-15-2018	Iconic EVO 2 27.5" (Gent)	City and trekking bicycle
23-15-2019	Iconic EVO 2 27.5" (Wave)	City and trekking bicycle
23-15-2020	Iconic EVO 3 27.5" (Gent)	City and trekking bicycle
23-15-2021	Iconic EVO 3 27.5" (Wave)	City and trekking bicycle
23-15-3027	Iconic EVO Belt 27.5" (Gent)	City and trekking bicycle
23-15-3037	Iconic EVO Belt 27.5" (Wave)	City and trekking bicycle
23-15-2022	Iconic EVO TR1 27.5"	City and trekking bicycle

Year of manufacture 2022 and year of manufacture 2023, complies with the following applicable EU provisions:

- Machinery Directive 2006/42/EC
- RoHS Directive 2011/65/EU
- Electromagnetic Compatibility Directive 2014/30/EU.

The safety objectives in the Low Voltage Directive 2014/35/EU have been met in compliance with Appendix I, No. 1.5.1 of the Machinery Directive 2006/42/EC.

The following harmonised standards have been applied:

- ISO 20607:2018 Safety machinery – Instruction handbook – General drafting principles
- EN 15194:2017 Cycles – Electrically power assisted cycles – EPAC Bicycles

The following other technical standards have been applied:

- EN 11243:2016: Cycles – Pannier racks for bicycles – Requirements and test methods
- EN 62133-2:2017 Secondary cells and batteries containing alkaline or other non-acid electrolytes. Safety requirements for portable sealed secondary cells, and for batteries made from them, for use in portable applications – Part 2: Lithium systems



Cologne, 02/05/2022

.....
 Egbert Hageböck, Chairman, ZEG Zweirad-Einkaufs-Genossenschaft eG

* Community member who is authorised to compile the technical documentation

II. Directive declaration of conformity with RED Directive

LED Remote

Robert Bosch GmbH, Bosch eBike Systems, hereby declares that the LED Remote radio system type complies with Directive 2014/53/EU. The complete EU declaration of conformity is available online at:

<https://www.bosch-ebike.com/conformity>

Intuvia 100

Robert Bosch GmbH, Bosch eBike Systems, hereby declares that the Intuvia 100 radio system type complies with Directive 2014/53/EU. The complete EU declaration of conformity is available online at:

<https://www.bosch-ebike.com/conformity>

14 Keyword index

- A**
- Activity tracking,
 - activate 154
 - Air valve, 39
 - position, 39
 - rear frame damper, 35
 - Articulated shaft,
 - maintain 199
 - Axle,
 - torque, 82
- B**
- Backlight,
 - adjust, 159
 - Ball bearings,
 - position, 49
 - Basic cleaning 192
 - Battery housing, 59
 - Battery level indicator (battery), 59
 - Battery level indicator, 72
 - Battery,
 - check, 99
 - clean, 192
 - dispose, 257
 - remove, 174
 - ship, 95
 - transport, 95
 - technical data 74
 - torques, 82
 - Battery, see rechargeable battery
 - Bead core, 47
 - position, 45
 - Bell,
 - check 190
 - use 166
 - Belt guard 20
 - Belt sprocket, 57
 - Belt, 57
 - check belt for wear 209
 - check tension 209
 - clean, 195
 - Gates Carbon Drive mobile app 210
 - Bicycle for young adults, 291
 - Bike headset, see steering headset
 - Bluetooth,
 - malfunctions, 18
 - Bowden cable, 55
 - check, 205
 - Brake cable, 55
 - torque, 83
 - Brake calliper, 56
 - position, 56
 - torque, 83
 - Brake disc, 56
 - check, 206
 - clean 195
 - replace, 254
 - position, 56
 - Brake lever, 56
 - clean 195
 - service, 200
 - Brake linings, 56
 - check, 206
 - replace, 254
 - retract, 133
 - position, 56
 - torque, 83
 - Brake, 29
 - check brake disc, 206
 - check brake linings, 206
 - check pressure point, 205
 - check, 190, 205
 - clean, 191
 - secure during transport 94
 - cable clip, 55
 - cover cap, 55
 - hydraulic, 55
 - insert pin, 55
 - knob, 55
 - mechanical, 55
 - union nut, 55
 - Braking distance, 290
 - Break in operation, 97
 - carry out 97
 - prepare 97
 - Brightness,
 - set. 159
 - Button,
 - minus, 62, 177
 - On-Off (battery) 59
 - push assist, 62, 177
- C**
- Cantilever brake,
 - torque, 84
 - Carbon seat post,
 - maintain, 198
 - Carbon suspension fork,
 - inspect, 231
 - Carcass, 46
 - position, 45
 - Cargo bike, 292
 - Cassette,
 - clean 194
 - CE marking, 290
 - Chain guard 20, 29
 - Chain guard,
 - clean, 195
 - torques 87
 - Chain stay, 30
 - Chain wheel, 57
 - Chain wheels,
 - clean 194
 - Chain, 57
 - check 207
 - check for wear 207
 - check tension 207
 - clean, 195
 - maintain 199
 - replace, 254
 - service, 234
 - tension, 254
 - position, 29, 57
 - Chainring brake,
 - torque, 87
 - Charger, 58
 - dispose, 257
 - Chassis, 30
 - Child seat, 160
 - City and trekking bicycles, 290
 - Clamping force,
 - adjust quick release 105
 - check quick release, 105
 - Clock,
 - adjust, 158
 - Compression damping, 41
 - Consumables, 293
 - Continuous power rating 292
 - Control panel,
 - clean, 192
 - Conventional valve, see Dunlop valve
 - Crank bearing,
 - torque, 88
 - Crank set,
 - torque, 88
 - Crown, 44
- D**
- Decommissioning, 290
 - Derailleur gears,
 - check 213
 - use, 181
 - Disc brake, 292
 - torque, 84
 - Display,
 - insert, 156

Down tube, 30
 Drive belt, 290
 Drive system, 57
 - switch on, 176
 electric, 58
 Dual pivot rim brake,
 torque, 84
 Dunlop valve, see conventional
 valve
 Dust seal, 44

E

eBike Flow,
 - register, 154
 Electrical control system, 290
 Emergency stop 292
 Emergency stop system 21

F

Fault, 291
 Folding bicycle, 291
 Fork steerer, 44, 291
 Fork,
 - check 189
 - maintain, 191
 position, 29
 suspended, 291
 Fracture, 290
 Frame number,
 position, 29
 Frame, 30
 31
 - check 189
 - clean, 193
 - inspect, 228
 - maintain, 191, 196
 carbon frame, 30
 position, 29
 Freewheel,
 torque, 84
 French valve, see Presta valve
 Front derailleur,
 - clean, 194
 torque, 91
 Front light, 58
 position, 29
 Front wheel brake,
 - brake, 180
 Front wheel, see Wheel

G

Gear hub,
 - inspect, 229

Gear shift,
 - adjust Bowden-cable-
 operated twist grip, dual-
 cable 216
 - check 214
 - check electric gear shift,
 214
 - switch gears, 182
 - use, 181

Guards,
 - check 189

H

Handbrake, 290
 torque, 87
 Handlebars, 37, 61
 - check, 111, 213
 - clean, 193
 - maintain, 197
 - use 167
 - use bar ends 167
 position, 29
 torque, 88
 Handles,
 - check 190
 - clean 193
 - maintain, 197
 - use leather handles 167
 Head tube, 30
 Headlight,
 - adjust, 153
 - check, 212
 - clean 191
 torque, 91
 Headlight, see Front light
 Headset, see steering headset
 Hub axle,
 position, 49
 Hub body,
 position, 49
 Hub gear,
 - check 214
 Hub, 49
 - adjust ROHLOFF 215
 - clean, 194
 - maintain 198
 - service 219
 hub, 29
 position, 45
 torque, 89
 without additional features,
 49
 Hydraulic brake system,
 - check 205

I

Initial commissioning, 99

J

Jockey wheel,
 - maintain 199

K

Key,
 Plus, 157
 plus, 62, 177
 Kickstand,
 - clean, 193
 - maintain, 197
 - stability 216
 position, 29

L

Language,
 - select, 158
 Leather handles,
 - clean 193
 - maintain, 197
 Leather saddle,
 - clean, 194
 - maintain, 198
 Level of assistance, 63, 65, 72
 - select 179
 - select, 179
 ECO, 63
 OFF, 63, 65
 TOUR, 63
 TURBO, 63, 65
 LIMOTEC seat post,
 - fit 110
 Lock function,
 - set up, 155

M

Maintenance, 293
 Manufacturer, 12, 291
 Mechanical,
 - gear shift 214
 Minimum insertion depth
 marking, 123
 Minimum insertion depth, 292
 Minus button, 62, 177
 Model year, 292
 Motor cover 20
 Motor cover,
 torques, 88
 Motor, 58
 - clean, 192
 torques 88

- Mountain bike, 291
Mountain bike, see MTB
MTB, see mountain bike
Mudguard 20
Mudguard,
- clean, 193
- maintain, 197
position, 29
Mudguards,
- check, 189
- N**
Nameplate, 28
Negative deflection, 292
Negative deflection, see Sag, 33
Nipple holes,
- check, 204
Nipple well,
- check, 204
- O**
Off-road tyres, 46
On-board computer, 60
- adjust 154
- adjust, 157
- attach, 156
- charge battery, 177
- clean 192
- connect to a smartphone.
154
- remove, 156
- replace battery, 155
torques, 82
On-board display,
- secure 156
Operating instructions, 290
Operating status indicator, 72
- P**
Pannier rack battery,
- remove, 174
Pannier rack,
- care 197
- change, 166
- check 189
- clean, 193
- inspect, 228
- use, 165
position, 29
Patent seat post, 52
Pedal,
- clean, 191
- fit 109
- maintain, 199
torque, 90
- Pedelec, 290
- adjust 116
- after each ride, 191
- assemble 98
- before each ride 164, 189
- check, 201
- clean 192
- commission 99
- initial inspection 217
- inspect (specialist dealer)
217
- major inspection 217
- sell, 111
- service 196
- ship, 95
- unpacking 98
- use 165
- Placing on the market, 291
Plus button, 62, 157, 177
Position, 29
Pressure point, 290
Puncture protection belt, 47
position, 45
Push assist button, 62, 177
Push assist,
- use 178
- Q**
Quick release, 293
- inspect, 230
position, 49
Quick releases,
- check 189
Quickly adjustable 36
- R**
Racing bicycle valve, see Presta
valve
Racing bicycle, 292
Rear derailleur,
- maintain, 199
- position 57
torque, 91
Rear frame damper, 33
- adjust compression
damper, 172
- adjust rebound damper,
150
- adjust SR Suntour rebound
damper, 151
- adjust SR Suntour sag, 146
- adjust SR Suntour, 173
- adjust threshold, 172
- check 189
- clean 191
- inspect, 228
- lock, 169
- maintain, 219, 228
- solve problem 248
-adjust sag, 143, 145
air reservoir, 35
compression lever, 35
damper unit, 35
O-ring, 35
overall length, 35
rebound adjuster wheel, 35
sag, 35
SR SUNTOUR Edge LOR8
Trunnion Mount, 35
Rear frame fork end, 30
Rear frame seat stay, 30
Rear light, 58
- clean 191
position, 29
Rear wheel brake, 56
Rebound adjuster, 39
position, 39
Rebound damping, 40
Rebound, 293
Rechargeable battery, 59, 290
Rechargeable battery, see
battery
Reflector,
position, 29
Reflectors,
- clean 191
Retainer guard, 59
Riding light
- switch on 178
Riding light,
- adjust, 153
- check, 190, 212
- switch off 178
Rim brake locking lever 55
Rim, 48
- replace, 254
position, 45
Rims,
- maintain, 198
Road tyres, 46
- S**
Saddle, 166
- change saddle tilt, 121
- change the seat length,
124
- check 213
- clean, 193
- determine saddle height,
122, 124
- use, 166
position, 29

Sag 33
 Sag setting wheel,
 position, 39
 Sag,
 setting wheel, 44
 Scaverand valve, see Presta
 valve
 Seat post, 29, 52, 292
 - check 190, 213
 - clean, 193
 - inspect, 232
 - maintain, 198
 - patent seat post 52
 - suspension seat post 52
 remote control torque, 84
 torque, 85
 Seat tube, 30
 Securing hook, 59
 Settings,
 - change, 158
 - reset, 159
 Shift recommendation,
 - set, 159
 Shifter,
 - clean 194
 - maintain, 199
 torque, 90
 Shut-off speed, 290
 Size, 31
 Slicks, 46
 Slippage, 292
 Software,
 - update, 154
 Spare part, 291
 Spoke nipples, 48
 - maintain, 198
 position, 45
 Spokes, 48
 - check, 204
 - replace 254
 position, 45
 Steering headset 36
 Steering headset,
 - grease, 229
 - inspect, 229
 position, 29
 Steering system, 36
 Stem, 36
 - adjust 165
 - check, 111, 213
 - clean, 193
 - inspect, 229
 - maintain, 197
 position, 29
 torque, 92
 Suspension fork, 37, 291
 - clean 191, 193
 - inspect, 231
 - maintain, 191, 196
 Suspension seat post 52
 Suspension seat post,
 - clean, 191
 - maintain, 198
 Switching element,
 - clean 194

T

Threshold, 172
 Time format,
 - set, 158
 Top tube, 30
 Total deflection 291
 Trailer, 161
 Transportation, 93
 Transporting, see
 Transportation
 Tread, 46
 position, 45
 Tube,
 - replace, 254
 Tyre design types, 45
 Tyre pressure, 45
 - change, 201
 - check, 201
 Tyre size, 45
 Tyre,
 position, 45
 Tyres, 45
 - check, 203
 - clean 194
 Tyres,- Tube-type tyres 45

U

Units,
 - select 158
 USB cover,
 - check 190
 USB port,
 - use, 177
 User account,
 - create, 154

V

Valve, 45
 Dunlop valve, 48
 position, 45
 V-Brake brake,
 torque, 92
 Vehicle,
 technical data, 73

W

Wear, 290
 Wheel, 45, 292
 - check concentricity 189
 - check, 201
 - fit 103, 104, 107, 108
 Winter break, see Break in
 operation
 Work environment, 290

Y

Year of manufacture, 290